





Kinco[®]

Kinco HMIware User Manual

This manual is suitable for MT4000 and MT5000 series HMI
Read this manual carefully before you use the product

Safety Precautions

Read this manual and related manuals that mentioned in this manual carefully before you use the products, at the same time operate the products under the premise of full safety attention. In order to use the products safely, we use the following icons and graphic symbols to represent precautions, and there is some important safety content for the precautions icons, please be sure to observe them.

	Danger If rated precautions are not taken, it may cause personal injury or death.
	Warning If rated precautions are not taken, it may cause personal injury.
	Be Care If rated precautions are not taken, it may cause slightly personal injury
	Notice If rated precautions are not taken, it may cause undesirable result or state.
	Forbidden Some instructions, processes and remove operations are forbidden to ensure correct use of product

Put away this manual after reading, so that you can read it anytime.

Note when using the product:

- The following places should be avoided when using MT series HMI:
 - The place that the temperature and humidity exceeds the range of the specifications
 - The place with high humidity that may cause condensed water
 - The place that the temperature changes acutely
 - The place that is shined by ultraviolet ray
 - The place with heavy dust
 - The place that is polluted by chemicals
 - The place that is polluted by oily substance
 - The place with heavy shock and vibration
 - The place that is exposed to sunshine and wind directly.
- The communication cables that connect HMI and PLC should be kept far from equipments that may generate interference, like VFD, motor at the same time. At the same time do not put the control cable, power cable and high line in the same wireway or nearby, or the interference may causes the malfunction of the equipment.
- Please ensure the security of the system before you power on the HMI.

- The proper configuration program is must when you want to use HMI to control PLC.
- Please install the USB driver before you use USB cable to download user data
- Please use finger or professional touch pen to operate the HMI
- The input operation may fail if the HMI is touched rapidly and continuously. Please input the content after the previous operation is input successfully.
- If the backlight is off or the HMI has no display, do not touch it by mistake. Please confirm the safety of the system and then operate it.
- If the dip switches are changed, the operation takes effects after the restart button is pressed or the HMI is powered off and on.
- When you change the 3V battery in HMI, please choose the right model and install it correctly.

Preface

Thank you for choosing Kinco MT series HMI.

Before you use the MT series products, please read this manual carefully and understand it fully to ensure the personal and equipment safety.

About this manual

This manual is for the usage and design way of Kinco HMIware configuration software (“Kinco HMIware” for short).



The content in this manual may not be updated in time because of the improvement of products or other reasons. We advice customer to pay attention to the information at our web site in order to ensure the right timely information of product specifications and accessories

When you use this manual, some rated manuals and supporting details maybe involved. They are:

- Communication Connection Help

This manual provides some information of rated communication setting, supported registers and communication cables when the MT series HMI communicate with the PLC that it supports.

- Product documents

Like catalog, products parameter list, order explanation, installation explanation manual, warranty and so on.

- Examples

Some demo programs at our site.

● Range of Application

This manual provides guides to Kinco HMIware, so that you can develop the project in HMI.

● Target Population

This manual is for the people, commissioning engineers, technical support and Maintenance engineers who use Kinco MT series HMI and has basic knowledge in automation area. If necessary, they should have the ability to program with C language.

● How to use this manual

This manual introduce the process, components, configuration methods, operation details and using skills from easy to difficult and step by step. It has three parts: introductory part, junior part and senior part. The new starter can start form introductory part, the one who has experience with Kinco HMIware just need to run over the introductory part, the engineer with rich experience in Kinco HMIware can start from the third part directly.

● The icons and terms in this manual

- Safety icons and terms



Danger

If rated precautions are not taken, it may cause personal injury or death.



Warning

If rated precautions are not taken, it may cause personal injury.



Be Care

If rated precautions are not taken, it may cause slightly personal injury



Notice

If rated precautions are not taken, it may cause undesirable result



Forbidden

Some instructions, processes and remove operations are forbidden to ensure correct use of product

- General information of icons and items



Provide tips or added information for using product correctly



Link to the rated information of other manuals



The items with explanation and footnotes.



Content for tips



Link to the rated information of this manual

- Items







➤ The following are the items in this manual:

Items used in this manual	Meaning
Kinco HMIware	The software for Kinco MT series HMI: Kinco HMIware configuration software
HMI	Kinco MT series HMI
PLC	Programmable Logic Controller
PC	Personal Computer
External Storage Device	The U disk or SD card that Kinco MT series HMI supports.

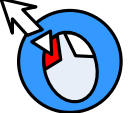
The following items are different from the official trade mark or name

Items used in this manual	Official trade mark or name
Windows 98	Microsoft® Windows® 98 Operation System
Windows Me	Microsoft® Windows® Me Operation System
Windows 2000	Microsoft® Windows® 2000 Operation System
Windows XP	Microsoft® Windows® XP Operation System
Windows Vista	Microsoft® Windows® Vista Operation System
Windows 7	Microsoft® Windows® 7 Operation System
Windows Server 2003	Microsoft® Windows Server® 2003 Operation System

The following items describe the operation of mouse:

Item	Operation Step	Picture
Click	Do not move the mouse; press the left button, then release.	
Right Click	Do not move the mouse; press the right button, then release.	
Double Click	Do not move the mouse; press the left button two times quickly, this operation only takes effect on left button.	
Drag	Hold pressing the left button and move the mouse, release the left button at the target position.	
Move	Move the mouse to the target position and stop.	
Input	Press the left button in the input box, then release. When there is a cursor in the input box, input the content.	
Operation	Click, double click or right click the blank	

● Precautions when using the software

Install the proper Kinco HMIware according to the language of the OS, if you install the Chinese version in English OS, some function may be abnormal, because there is no Chinese character library in English OS.

- Kinco HMIware is backward compatible, but not the reverse. That is to say, the project that compiled by the higher version software cannot be opened and compiled by lower version, but the project that compiled by lower version software can be opened and compiled by higher version.
- The *.pkg file that compiled by the version that earlier than EV5000 V1.3.0 cannot be decompiled
- Please remember the password if you use the project password, upload password and decompilation password, we cannot provide the reset the password service or any universal password.
- The display difference between the Kinco HMIware and HMI:
 - (1) When you configure the project, there are some grids as the aligning reference in Kinco HMIware configuration area, there is no grids in HMI screen.

Display in Kinco HMIware Display in HMI Screen

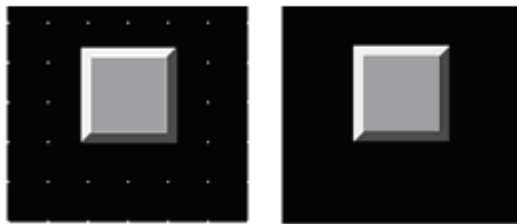

(2) The following size difference maybe happen when using dial scale and dial axis.

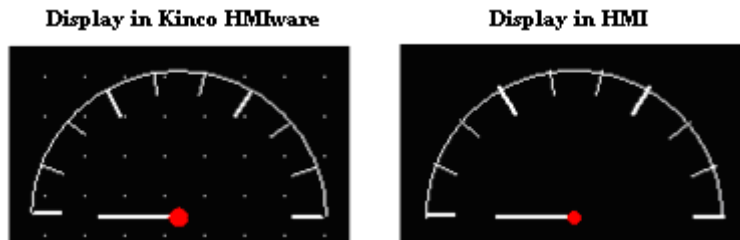

(3) If the graphic uses the gradient color as fill color, the following display difference maybe happen.

Display in the KincoHMIware Display in HMI

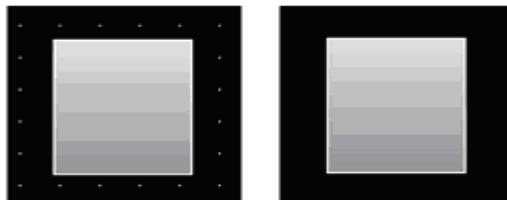

● Product Support

- Online support

If you have any question when using the product, you can contact our overseas technical engineers; they can support you online or by email.

● **Technical Training**

If you have any question about the product described in this manual, you can contact our company directly or local distributors. About the technical training, please pay attention to the information at our site or consult the sales manager.

● **Contact us**

Kinco Automation Ltd

Email: Sales@climatplc.ru

Index

Part1 Basic Part

Preface	1
1 Introduction	1
1.1 About Kinco HMIware	1
1.2 Features List of Kinco HMIware	1
2 Starting	13
2.1 How to use Kinco HMIware	13
2.2 How to get Kinco HMIware software	13
2.3 Kinco HMIware Installation and Operating Environment Requirement	13
2.4 Install/Uninstall	13
2.4.1 Install Kinco HMIware	13
2.4.2 Uninstall Kinco HMIware	14
2.5 Start/Quit	14
2.5.1 Start Kinco HMIware	14
2.5.2 Quit Kinco HMIware	15
2.6 System Language Change	15
2.7 F1 Help	16
2.8 Upgrade/Update	16
2.9 Software Compatibility	16
2.10 Install USB Driver	17
2.11 Software Application Program Introduction	19
3 Make Project	21
3.1 Project Requirement	21
3.2 System Analysis	22
3.3 Make Project	24
3.3.1 Create Project	24
3.3.2 Device Selection, Connection and Parameters Setting	25
3.3.3 Edit Frame	27
3.3.4 Save Project	46
3.3.5 Project Simulation	46
3.3.6 Download Project	47
3.4 Project Folder Introductions	47

Part2 Advanced Part

1 User Interface	51
1.1 Interface Layout	51
1.2 Menu	51
1.2.1 File Menu	51
1.2.2 Edit Menu	52

1.2.3 View Menu	52
1.2.4 Screen Menu.....	52
1.2.5 Draw Menu.....	53
1.2.6 Components Menu	53
1.2.7 Tools Menu.....	53
1.2.8 Option Menu	53
1.2.9 Window Menu	53
1.2.10 Help Menu.....	53
1.3 Toolbar.....	54
1.3.1 Basic Toolbar.....	54
1.3.2 Draw Toolbar.....	54
1.3.3 Page Switch Toolbar.....	54
1.3.4 Position Toolbar	54
1.3.5 Line Width Toolbar.....	55
1.3.6 Line Style Toolbar	55
1.3.7 System Toolbar.....	55
1.3.8 Database Toolbar.....	55
1.3.9 Code Edit Toolbar.....	55
1.3.10 Fill Effect Toolbar	55
1.3.11 Label Position Toolbar.....	56
1.3.12 State Switch Toolbar.....	56
1.3.13 Font Toolbar	56
1.3.14 Status Bar	56
1.3.15 Tip Text	56
1.3.16 Toolbar Options.....	56
1.4 Software window.....	56
1.4.1 Graph Element Window	57
1.4.2 Project Files Window	58
1.4.3 Project Sstructure Window.....	58
1.4.4 Message Window	59
1.4.5 Component List Window.....	60
1.5 Configuration Edit Area.....	61
1.5.1 Construct Window.....	61
1.5.2 HMI Edit Window	62
1.5.3 Graphic Edit Window.....	62
1.5.4 Macro Edit Window	63
1.5.5 Edit Initial Window	63
2 Basic Design Method.....	64
2.1 Window screen	64
2.1.1 Specification of window screen.....	64
2.1.2 Window Display Methods	64
2.1.3 Display Position	67
2.1.4 Display Order	67
2.1.5 Copy/Delete Windows.....	68

2.2 Draw	69
2.2.1 Image Format	69
2.2.2 Vector	69
2.2.3 Geometric Figures Attribution.....	72
2.2.4 About Fountain Fill	73
2.2.5 Bitmap.....	74
2.2.6 About Transparent Color	74
2.3 Text.....	75
2.3.1 Font Type.....	76
2.3.2 Dot Matrix Font.....	76
2.3.3 Vector Font	76
2.3.4 Graph Font	77
2.3.5 Text Attribute Edition.....	78
2.3.6 Notes for Using Vector Font	78
2.4 Keyboard	79
2.4.1 Keyboard Type	79
2.4.2 NUM Keyboard.....	81
2.4.3 ASCII Keyboard.....	83
2.4.4 HEX Keyboard.....	83
2.4.5 Create your Own Mumber Keyboard	84
2.4.6 Create your Oown Unicode Keyboard	86
2.4.7 Call Keyboard in the Group Component Library	87
2.5 Code Type.....	88
2.5.1 BIN.....	88
2.5.2 BCD	89
2.5.3 LSB	89
2.6 Language Switching	89
2.7 RTC Set	91
2.7.1 Through Special Registers.....	92
2.7.2 Calibrate System Time in System Setup Screen	93
2.7.3 System Time and PLC Time Synchronization.....	93
2.8 LOGO Screen (Logo)	96
2.8.1 LOGO Screen Specification	96
2.8.2 Init Screen Setting	96
2.8.3 Note for Using Init Screen.....	98
2.9 Exchange Serial.....	98
2.10 Replace Devices	99
2.10.1 Replace HMI	100
2.10.2 Replace PLC.....	101
2.11 Index Function.....	102
2.11.1 Index Register.....	102
2.11.2 Index Station Num.....	103
2.12 Buzzer.....	105
2.12.1 Touch Beep.....	105

2.12.2 Alarm Beep.....	106
2.13 Screen Saver	107
2.14 Password Setting	108
2.14.1 Project Protection	108
2.14.2 Screen Protection.....	108
2.14.3 Component Protection.....	109
2.15 Data Encryption.....	110
2.16 Animation Effects	112
2.17 Multi-Copy	115
2.18 Group.....	116
2.19 Find /Replace.....	119
3 Window.....	121
3.1 Window Types	121
3.2 System Default Window	123
3.3 Edit Window.....	124
3.3.1 Window Add.....	124
3.3.2 Window Opening.....	125
3.3.3 Window Copy/ Multi-Windows Copy.....	126
3.3.4 Window Deletion/ Multi-Windows Deletion.....	127
3.4 Window Attribute	128
3.4.1 Open Window Attribute Box	128
3.4.2 Window Attribute Descriptions	129
3.5 Components Related to Window	132
4 Component	133
4.1 Common Setting of Component	133
4.1.1 Create and Delete Component.....	133
4.1.2 Execution Order of Components	134
4.1.3 Methods to Open Attributes Window	135
4.1.4 Basic Setting.....	136
4.1.5 Tag Setting.....	138
4.1.6 Graphics Setting	139
4.1.7 Control Setting Option	140
4.1.8 Display Setting	143
4.1.9 Touch Sound Control.....	145
4.1.10 Save Historical Data.....	145
4.2 Button/Switch Components	147
4.2.1 Bit State Setting.....	147
4.2.2 Bit State Switch.....	150
4.2.3 Multiple State Setting.....	152
4.2.4 Multiple State Switch	155
4.2.5 Combination Operations.....	157
4.2.6 Function Key	158
4.3 Lamp Component	164
4.3.1 Bit State Lamp.....	164

4.3.2 Multiple State Display	166
4.4 Number Components.....	167
4.4.1 Number Input	169
4.4.2 Number Display	170
4.5 Text Components.....	170
4.5.1 Text Input	174
4.5.2 Text Display	174
4.5.3 Note Book	175
4.6 Graph/Meter Components	175
4.6.1 Trend Curve.....	178
4.6.2 XY Plot.....	190
4.6.3 Oscillograph	194
4.6.4 Meter	196
4.6.5 Bar Picture.....	198
4.7 Alarm Component	201
4.7.1 Event Display	203
4.7.2 Historical Event Display.....	207
4.7.3 Event Bar.....	208
4.7.4 Alarm Display	210
4.7.5 Alarm Bar	210
4.8 Window Component.....	211
4.8.1 Direct Window	211
4.8.2 Indirect Window.....	213
4.9 Graphic Components	214
4.9.1 Vector Graph	214
4.9.2 Bitmap.....	214
4.9.3 Free Plotting	214
4.9.4 Dynamic Graph	215
4.9.5 GIF	215
4.10 Video Input Component.....	216
4.10.1 Video	216
4.10.2 Camera	218
4.11 Multiple State Neon Lamp.....	219
4.11.1 Bit State Neon Lamp	219
4.11.2 Bit State Neon Lamp	220
4.12 Animation Components	221
4.12.1 Animation	221
4.12.2 Moving Component.....	222
4.12.3 Pipeline.....	226
4.13 Grid Components.....	227
4.13.1 Grid	227
4.13.2 Historical Data Display	228
4.13.3 User Info Display	233
4.13.4 Operation Log	234

4.13.5 Data Report	236
4.13.6 Data Curve	246
4.14 Data Transmission Component.....	252
4.14.1 Recipe.....	252
4.14.2 Data Transmission	254
4.15 Project Database	255
4.15.1 Text Library.....	256
4.15.2 Address Tag	257
4.15.3 Event Information.....	258
4.15.4 Alarm Information	262
4.15.5 PLC Control	264
4.15.6 Sound Lib	271
4.15.7 Data Logger.....	272
4.15.8 Schedule List	274
4.16 Auxiliary Component	278
4.16.1 Scale	278
4.16.2 Timer	279
4.16.3 Scroll Bar	282
4.16.4 Date/Time	283
4.16.5 Note Pad.....	283
4.16.6 File List	284
4.16.7 Trigger Touch	284
5 Better Understanding of Library	286
5.1 Text Library	286
5.1.1 Create a Text Library.....	286
5.1.2 Export/Import Text Library	288
5.1.3 Set the Language of Text Library	288
5.1.4 Text Library Application	289
5.2 Address Tag Library	291
5.2.1 Build a Address tag Library.....	291
5.2.2 Address Tag Application.....	291
5.3 Graphic Library	292
5.3.1 Import Graphics.....	292
5.3.2 Build New Graphics	296
5.3.3 Edit Graphics.....	305
5.3.4 How to Use the Graphics.....	308
5.4 Sound Lib Application.....	310
5.4.1 Import Audio File	310
5.4.2 How to Use Audio File.....	312
6 System Parameters.....	314
6.1 HMI Attributes	314
6.1.1 HMI.....	314
6.1.2 Task Bar.....	315
6.1.3 HMI Extended Attributes	317

6.1.4 HMI System Information Text.....	320
6.1.5 Security Levels Setting.....	321
6.1.6 User Permissions Setting.....	321
6.1.7 Historical Events Storage.....	322
6.1.8 Print Setting.....	323
6.1.9 Serial Port Setting.....	324
6.1.10 Extended Memory.....	326
6.2 PLC Attribute.....	326
7 Compile/Simulate/Download/Upload.....	328
7.1 Compilation.....	328
7.1.1 Methods of Compilation.....	328
7.2 Simulation.....	328
7.2.1 Modes of Simulation.....	328
7.2.2 Exit Simulation.....	329
7.3 Download.....	329
7.3.1 Download Method Selection.....	329
7.3.2 Download via U disk or SD card.....	331
7.3.3 Download Selection.....	331
7.4 Upload/ Download/Compile Project via KHManager.....	335
8 KHManager.....	336
8.1 Introduction to KHManager.....	336
8.2 Methods of Open KHManager.....	337
8.3 Download.....	337
8.4 Upload.....	338
8.5 System Operation.....	338
8.6 Get Version.....	338
8.7 Decompile Operation.....	338
8.8 Data Decryption.....	339
9 Macro.....	340
9.1 Macro Editing Environment.....	340
9.2 Macro Edit.....	340
9.2.1 Build Macro.....	340
9.2.2 Delete Macro.....	341
9.2.3 Rename Macro.....	341
9.2.4 Program Macro.....	342
9.2.5 Execute Macro.....	345
9.3 Macro Application.....	345
9.4 Local Variable Function.....	347
9.5 Array Application.....	348
9.6 Some Notes on the Macro.....	351
10 Password.....	352
10.1 Project Protection.....	353
10.1.1 Project Password Protection.....	353
10.1.2 Upload Password Protection and Prohibit Uploading.....	353

10.1.3	Decompilation Password Protection and Prohibit Decompiling	355
10.1.4	Download Password Protection	356
10.2	Window Protection	357
10.2.1	Window Password Setting	357
10.2.2	Security Level Setting of Window	358
10.2.3	System reserved registers related to security level	359
10.2.4	Security level password input window	359
10.2.5	Modifying Password Online	360
10.2.6	Application of Passwords Required for Switching Windows	361
10.3	Component Protection	362
10.3.1	Security Level Protection for Components	362
10.3.2	User Permission Protection for Components	362
10.3.3	System Reserved Registers Related to User Permissions	363
10.3.4	System Reserved Registers Related to Add/Delete Users and User Permissions Online	363
10.3.5	Window for User Permission Password Input	364
10.3.6	Application of Security Level Protection for Components	365
10.3.7	Application of User Permission Protection for Component	366
11	Recipe/ RecipeEditor	375
11.1	Register Related to the Recipe	375
11.2	Method for Checking the Recipe Size	376
11.2.1	Method for Checking the RW Size	376
11.2.2	Calculation for Recipe Address Range	377
11.3	Usage of Recipe	378
11.3.1	Absolute Address	378
11.3.2	Index Address	378
11.3.3	Application of Recipe	379
11.4	RecipeEditor	381
11.4.1	Recipe Editor Start-up	382
11.4.2	Recipe Editor User interface	383
11.4.3	Usage of RecipeEditor	385
11.5	Recipe Uploading/ Downloading/ Clearing	392
12	KHMonitor	393
12.1	Descriptions of KHMonitor	393
12.2	Start KHMonitor	393
12.3	KHMonitor Interface	393
12.4	How to Use KHMonitor	394
13	Print	397
13.1	Type of Printer supports local printing	397
13.2	Printing-related Components	398
13.3	Pictbridge Print	400
13.4	Print Function Setting Method	402
13.4.1	Local Print: HMI serial is connected directly to the Printer	402
13.4.2	Local Print: HMI USB Slave is connected directly to the Printer	403
13.4.3	Network Print (remote print): Through Network Printer to Print HMI Screen	404

13.4 Print Page Application Skills	409
13.5 Print Error	410
14 HMI Communication	411
14.1 Serial Communication	411
14.1.1 HMI and PC Serial Communication	411
14.1.2 HMI and PLC /Controller Serial Communication	411
14.1.3 Serial Communication Related Settings	418
14.2 Network Port Communication	418
14.2.1 HMI and PC Network Port Communication	418
14.2.2 HMI and HMI Port Communication Network	419
14.2.3 HMI and PLC/Controller Network Port Communication	420
14.2.4 FTP Function	423
14.3 Field Bus Communication	426
14.3.1 CAN Communicate	426
14.3.2 DP Communicate	427
14.4 MPI Communicate	432
14.5 MODBUS Protocol Applications (Master-slave mode)	436
14.5.1 MODBUS Protocol Overview	436
14.5.2 MODBUS Protocol Communication Format	438
14.5.3 MODBUS Protocol in the HMI Application	444
15 VNC	450
15.1 Various client-sides	450
15.2 Access via LAN	451
15.2.1 Remote control HMI by PC via LAN	451
15.2.2 Remote control HMI by mobile via LAN	454
15.2.3 Remote control HMI by browser via LAN	455
15.3 Access via WAN	457
16 Register	461
16.1 Local Registers of HMI	461
16.1.1 Bit Address	461
16.1.2 Word Address	461
16.2 System Special Registers of HMI	462
16.2.1 Parameter Setting of Hardware	463
16.2.2 System Setting	464
16.2.3 Components Setting	469
16.2.4 Security Level and User Permission	471
16.2.5 Data and Project Management	473
16.2.6 Communication	474

Part3 Hardware Part

1 Name and Specification	479
1.1 Name of Each Part	479
1.2 Specifications of Each Part	480
2 Connection with Preiferal Equipments	485

2.1 Connection via Serial Port.....	485
2.2 Connection via USB Interfaces	487
2.3 Connection via LAN Interfaces.....	488
3 System Setting Mode.....	490
3.1 Methods to Display System Setting Mode	490
3.2 System Setting.....	490
4 Touch Screen Calibrate Mode.....	492
4.1 Methods to Display Touch Screen Calibrate Mode	492
4.2 Touch Screen Calibrate Setting	492
5 Firmware Update Mode.....	493
5.1 Methods to Display Firmware Update Mode	493
5.2 Firmware Update Setting.....	493
6 Maintenance and Tending.....	494
6.1 Maintenance	494
6.2 Tending.....	494
Appendix 1 Regular PLC Used for HMI	496
Appendix 2 List of Error Information.....	500
Appendix 3 List of System Prompt Message.....	505

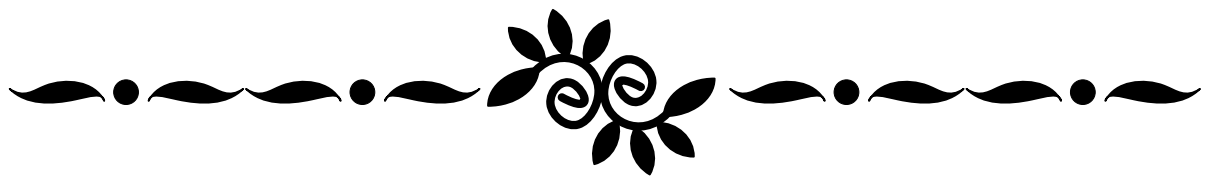

Basic Part



1 Introduction

This chapter mainly introduces the features and functions of Kinco HMIware Configuration Software.



1.1 About Kinco HMIware

Kinco HMIware Configuration Software (Hereinafter referred to as “Kinco HMIware”) is a human-machine interface(HMI) configuration software developed by Kinco Electric (Shanghai) Ltd. (Hereinafter referred to as “Kinco”) ,it is special for MT4000/5000 series HMI. Kinco HMIware provides a powerful integrated development environment for users. Products are widely applied in various kinds of fields such as medical, chemical industry, electric power, printing, textile, food, national defense and engineering machinery, intelligent household, high speed railway and so on.

1.2 Features List of Kinco HMIware

- Edit operation functions

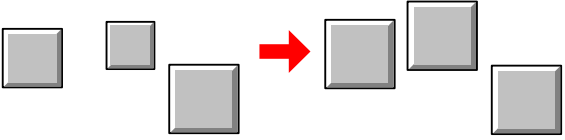
Functions	Diagrams	Notes
Batch to modify font properties		Details please refer to 【Advanced Part 2.3.5 Text Attribute Edition】
Batch to modify graph properties		Details please refer to 【Advanced Part 2.2.3 Geometric Figures Attribution】
Batch to copy windows		Details please refer to 【Advanced Part 3.3.3 Window Copy /Multi-Windows Copy】
Crossing projects to copy components		Details please refer to 【Advanced Part 2.1.5 Copy/Delete windows】
Batch to set components alignment		Details please refer to 【Advanced Part 1.2.2 Edit Menu】

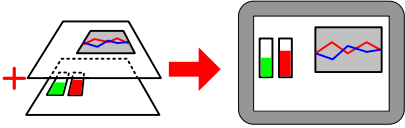
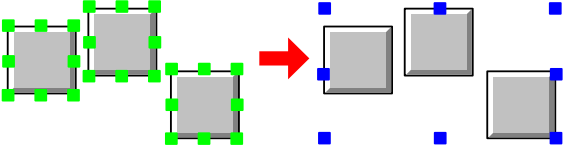
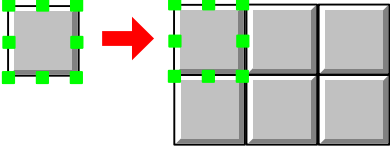
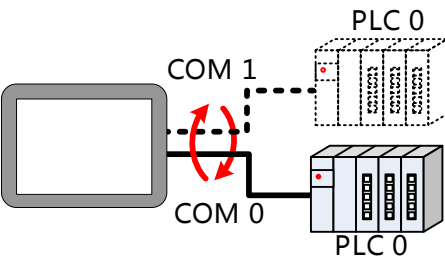
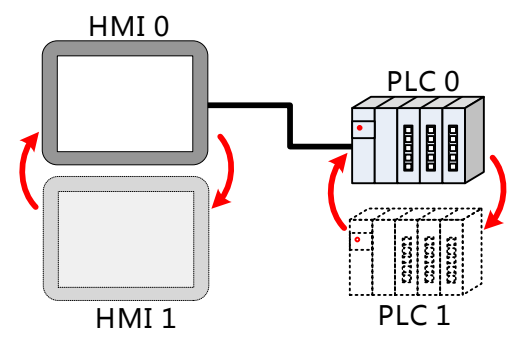
<p>Batch to set components same size</p>		<p>Details please refer to 【Advanced Part 1.2.2 Edit Menu】</p>
<p>Batch to set components same space</p>		<p>Details please refer to 【Advanced Part 1.2.2 Edit Menu】</p>
<p>Overlay windows</p>		<p>Details please refer to 【Advanced Part 2.1.2 Windows Display Methods】</p>
<p>Group components</p>		<p>Details please refer to 【Advanced Part 2.18 Group】</p>
<p>Multi-copy components</p>		<p>Details please refer to 【Advanced Part 2.17 Multi-copy】</p>
<p>Exchange serial ports</p>		<p>Details please refer to 【Advanced Part 2.9 Exchange Serial】</p>
<p>Exchange devices</p>		<p>Details please refer to 【Advanced Part 2.10 Replace Devices】</p>

● Functions of Components

Switch and lamp

Functions	Diagrams	Notes
-----------	----------	-------

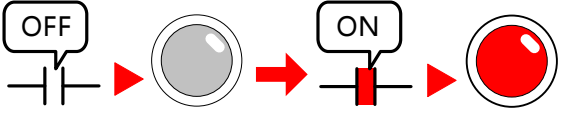
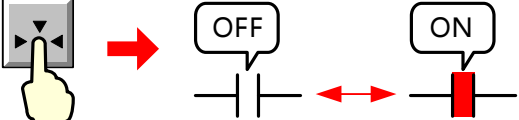
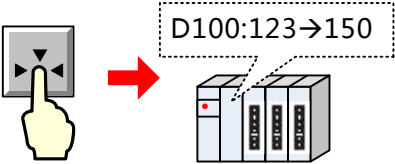
<p>Lamps for displaying states of device's address</p>		<p>Details please refer to 【Advanced Part 4.3 Lamp Component】</p>
<p>Switches for changing states of device's address</p>		<p>Details please refer to 【Advanced Part 4.2 Button/Switch Component】</p>
<p>Switches for changing the value of device's address</p>		<p>Details please refer to 【Advanced Part 4.2 Button/Switch Component】</p>

Number/Text input and display

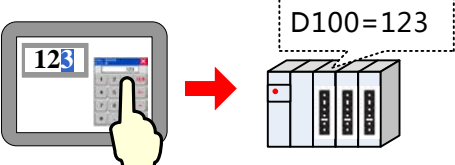
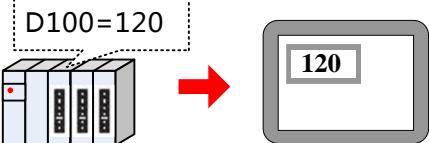
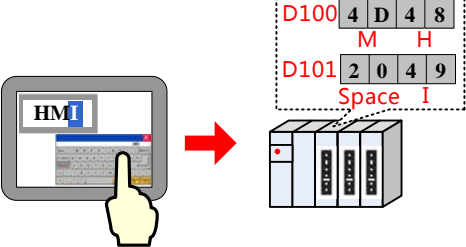
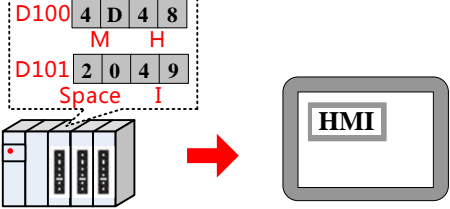
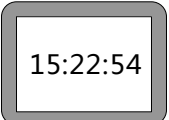
Functions	Diagrams	Notes
<p>Number input</p>		<p>Details please refer to 【Advanced Part 4.4.1 Number Input】</p>
<p>Number display</p>		<p>Details please refer to 【Advanced Part 4.4.2 Number Display】</p>
<p>Text input</p>		<p>Details please refer to 【Advanced Part 4.5.1 Text Input】</p>
<p>Text display</p>		<p>Details please refer to 【Advanced Part 4.5.2 Text Display】</p>
<p>System time display</p>		<p>Details please refer to 【Advanced Part 4.16.4 Date/Time】</p>

Text annotations		Details please refer to 【Advanced Part 2.3 Text】
------------------	---	---



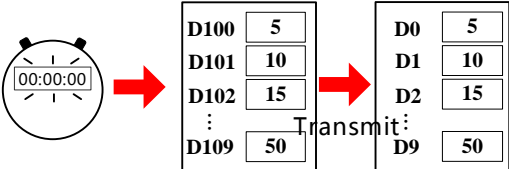
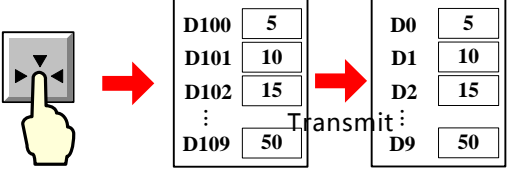
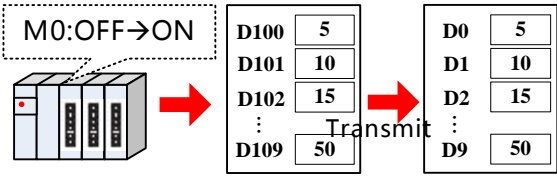
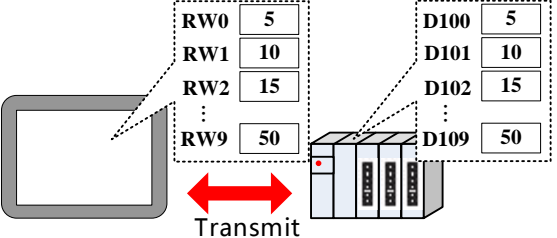

Data transmission

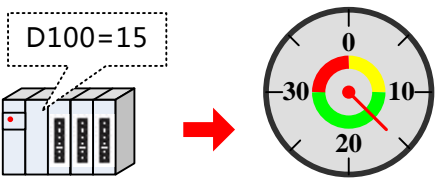
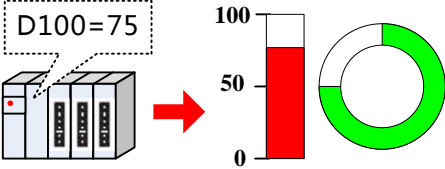
Functions	Diagrams	Notes
Transmit data by timing		Details please refer to 【Advanced Part 4.16.2 Timer】
Transmit data by touch		Details please refer to 【Advanced Part 4.14 Data Transmission Component】
Transmit data by trigger		Details please refer to 【Advanced Part 4.14.2 Data Transmission】
Data transmit by recipe		Details please refer to 【Advanced Part 4.14.1 Recipe Data】

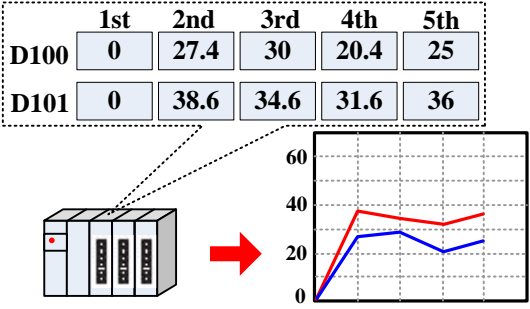
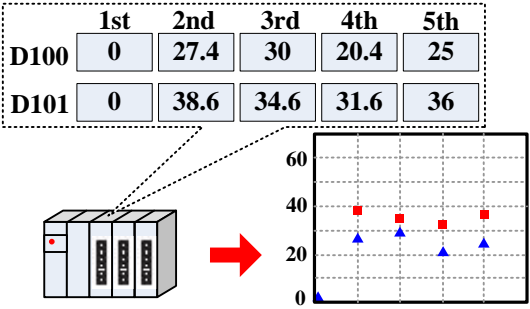
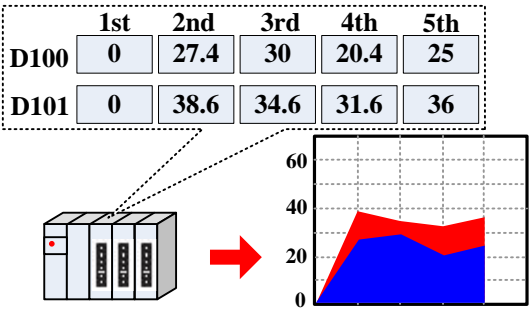
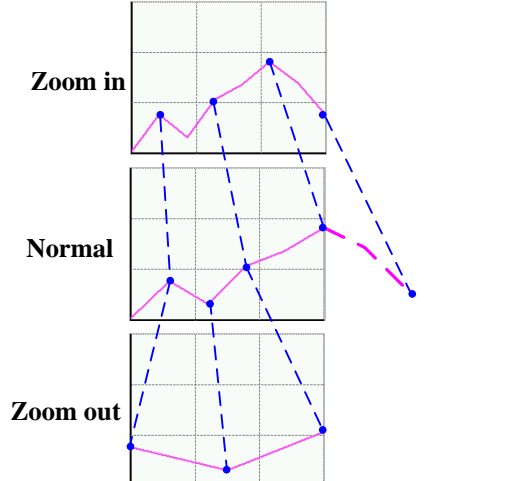
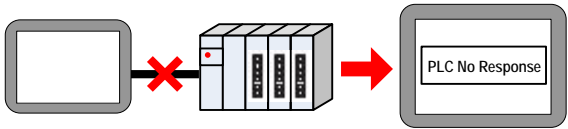
Meter and Graph

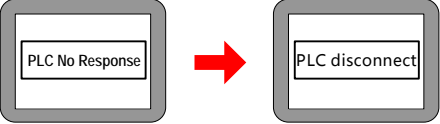
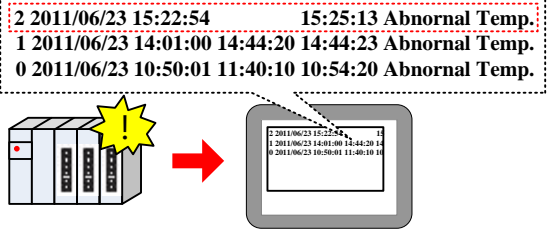
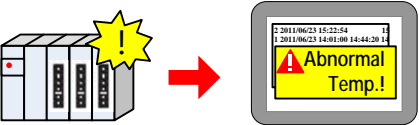
Functions	Diagrams	Notes
Display data as meter		Details please refer to 【Advanced Part 4.6.4 Meter】
Display data as bar graph		Details please refer to 【Advanced Part 4.6.5 Bar Picture】

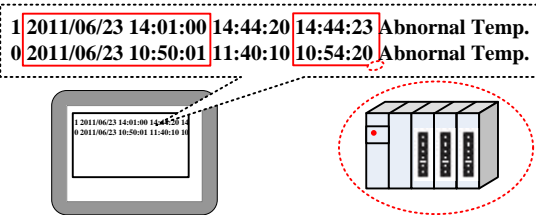
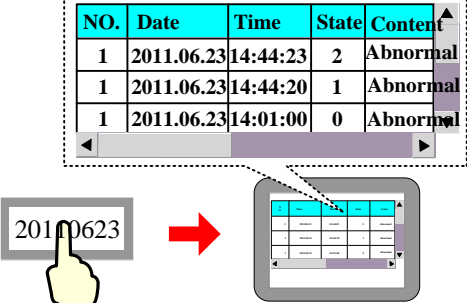
<p>Display data as trend curve</p>		<p>Details please refer to 【Advanced Part 4.6.1 Trend Curve】</p>
<p>Display data as dot graph.</p>		<p>Details please refer to 【Advanced Part 4.6.1 Trend Curve】</p>
<p>Display data as projection graph</p>		<p>Details please refer to 【Advanced Part 4.6.1 Trend Curve】</p>
<p>Zoom of trend curve</p>		<p>Details please refer to 【Advanced Part 4.6.1 Trend Curve】</p>
<p>Alarm</p>		
<p>Functions</p>	<p>Diagrams</p>	<p>Notes</p>
<p>System information alarm</p>		<p>Details please refer to 【Advanced Part 6.1.4 HMI System Information Text】</p>

<p>User-defined system alarm information</p>		<p>Details please refer to 【Advanced Part 6.1.4 HMI System Information Text】</p>																				
<p>Display user-defined alarm information when alarm happen</p>		<p>Details please refer to 【Advanced Part 4.7 Alarm Component】</p>																				
<p>Display alarm information in popup window when alarm happen</p>		<p>Details please refer to 【Advanced Part 4.7 Alarm Component】</p>																				
<p>The buzzer will peal when alarm happen</p>		<p>Details please refer to 【Advanced Part 4.7 Alarm Component】</p>																				
<p>Obtain the alarm time of event information from external clock.</p>		<p>Details please refer to 【Advanced Part 2.7.3 System time and PLC CPU time synchronization】</p>																				
<p>Query historical event records by inputting date or file number</p>	 <table border="1" data-bbox="533 1290 938 1451"> <thead> <tr> <th>NO.</th> <th>Date</th> <th>Time</th> <th>State</th> <th>Content</th> </tr> </thead> <tbody> <tr> <td>1</td> <td>2011.06.23</td> <td>14:44:23</td> <td>2</td> <td>Abnormal</td> </tr> <tr> <td>1</td> <td>2011.06.23</td> <td>14:44:20</td> <td>1</td> <td>Abnormal</td> </tr> <tr> <td>1</td> <td>2011.06.23</td> <td>14:01:00</td> <td>0</td> <td>Abnormal</td> </tr> </tbody> </table>	NO.	Date	Time	State	Content	1	2011.06.23	14:44:23	2	Abnormal	1	2011.06.23	14:44:20	1	Abnormal	1	2011.06.23	14:01:00	0	Abnormal	<p>Details please refer to 【Advanced Part 4.7.2 Historical Event Display】</p>
NO.	Date	Time	State	Content																		
1	2011.06.23	14:44:23	2	Abnormal																		
1	2011.06.23	14:44:20	1	Abnormal																		
1	2011.06.23	14:01:00	0	Abnormal																		
<p>Import/Export alarm/event logon information</p>		<p>Details please refer to 【Advanced Part 4.7 Alarm Component】</p>																				

Conditional control

Functions	Diagrams	Notes
-----------	----------	-------

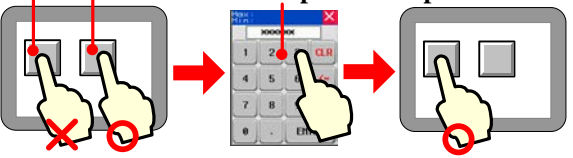
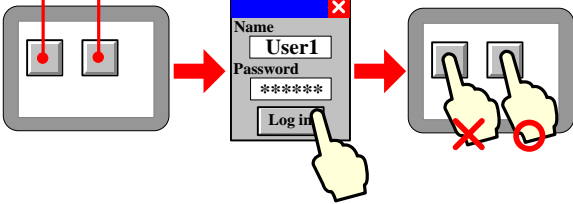
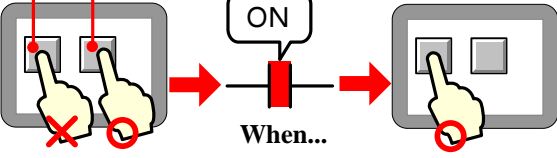
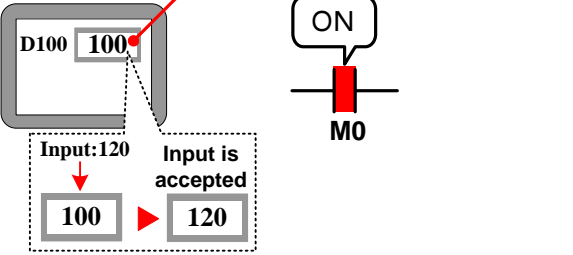

<p>Components are limited by user security level.</p>	<p>Controlled by security level 3 Controlled by no security level Input level 3 password</p> 	<p>Details please refer to [Advanced Part 4.1.7 Control Setting Option]</p>												
<p>Components are limited by user permission.</p>	<p>User access list</p> <table border="1" data-bbox="467 544 786 656"> <thead> <tr> <th>Name</th> <th>Access1</th> <th>Access2</th> <th>Access3</th> </tr> </thead> <tbody> <tr> <td>User1</td> <td>○</td> <td>×</td> <td>×</td> </tr> <tr> <td>User2</td> <td>○</td> <td>○</td> <td>○</td> </tr> </tbody> </table> <p>Controlled by access 2 Controlled by access 1</p> 	Name	Access1	Access2	Access3	User1	○	×	×	User2	○	○	○	<p>Details please refer to [Advanced Part 4.1.7 Control Setting Option]</p>
Name	Access1	Access2	Access3											
User1	○	×	×											
User2	○	○	○											
<p>Components are limited by the status of registers.</p>	<p>Operate condition</p> <table border="1" data-bbox="467 1003 627 1104"> <tr> <td>ON</td> <td>OFF</td> </tr> <tr> <td>○</td> <td>×</td> </tr> </table> <p>Controlled by register state Controlled by no condition</p> 	ON	OFF	○	×	<p>Details please refer to [Advanced Part 4.1.7 Control Setting Option]</p>								
ON	OFF													
○	×													
<p>Notification operation</p>	<p>Notify M0 turn on</p> 	<p>Details please refer to [Advanced Part 4.1.7 Control Setting Option]</p>												

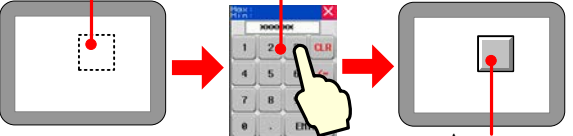
Conditional Display

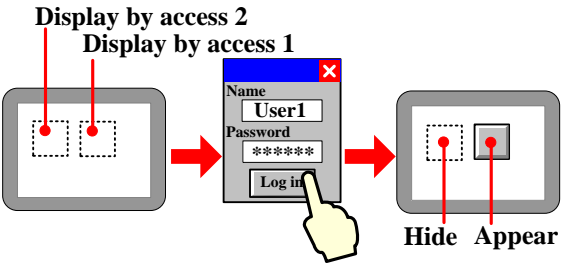
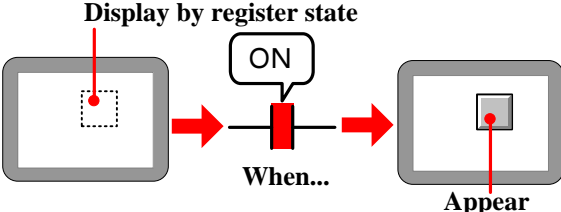
Functions	Diagrams	Notes
<p>Display components according to user security level.</p>	<p>Display by security level 3 Input level 3 password Appear</p> 	<p>Details please refer to [Advanced Part 4.1.8 Display Setting]</p>

<p>Display components according to user permission.</p>	<p>User access list</p> <table border="1"> <thead> <tr> <th>Name</th> <th>Access1</th> <th>Access2</th> <th>Access3</th> </tr> </thead> <tbody> <tr> <td>User1</td> <td>○</td> <td>×</td> <td>×</td> </tr> <tr> <td>User2</td> <td>○</td> <td>○</td> <td>○</td> </tr> </tbody> </table> <p>Display by access 2 Display by access 1</p> 	Name	Access1	Access2	Access3	User1	○	×	×	User2	○	○	○	<p>Details please refer to 【Advanced Part 4.1.8 Display Setting】</p>
Name	Access1	Access2	Access3											
User1	○	×	×											
User2	○	○	○											
<p>Display components according to the status of registers.</p>	<p>Display condition</p> <table border="1"> <thead> <tr> <th>ON</th> <th>OFF</th> </tr> </thead> <tbody> <tr> <td>○</td> <td>×</td> </tr> </tbody> </table> <p>Display by register state</p> 	ON	OFF	○	×	<p>Details please refer to 【Advanced Part 4.1.8 Display Setting】</p>								
ON	OFF													
○	×													

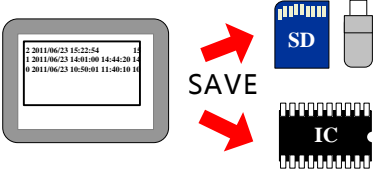
● Data Storage Function

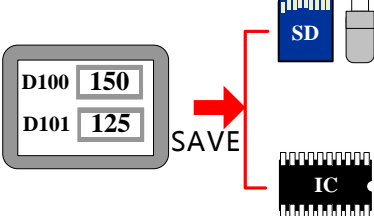
Functions	Diagrams	Notes
<p>Save historical event information.</p>		<p>Details please refer to 【Advanced Part 6.1.7 Historical Events Storage】</p>
<p>Save sampling data of trend curve.</p>		<p>Details please refer to 【Advanced Part 4.1.10 Save Historical Data】</p>
<p>Save operation records</p>		<p>Details please refer to 【Advanced Part 6.1.3 HMI Extended Attributes】</p>
<p>Save recipe data</p>		<p>Details please refer to 【Advanced Part 4.14.1 Recipe】</p>

● Data Clear Function

Functions	Diagrams	Notes
Clear historical event records.		Details please refer to 【Advanced Part 4.7 Alarm Component】
Clear historical data records of trend curve.		Details please refer to 【Advanced Part 8.3 Download】
Clear historical recipe data.		Details please refer to 【Advanced Part 8.3 Download】

● Window Changing Function

Functions	Diagrams	Notes
Change window by touch button.		Details please refer to 【Advanced Part 4.2.6 Function Key】
Change window by PLC control.		Details please refer to 【Advanced Part 4.15.5 PLC Control】
Popup other window in current window.		Details please refer to 【Advanced Part 4.8 Window Component】

● Password Protection Function

Functions	Diagrams	Notes
-----------	----------	-------

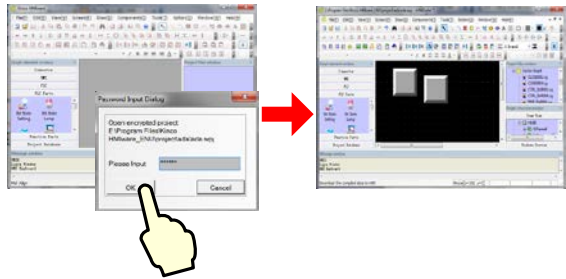
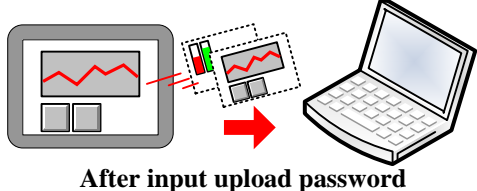
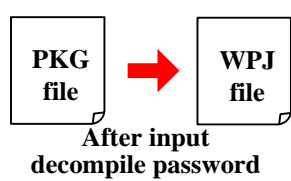
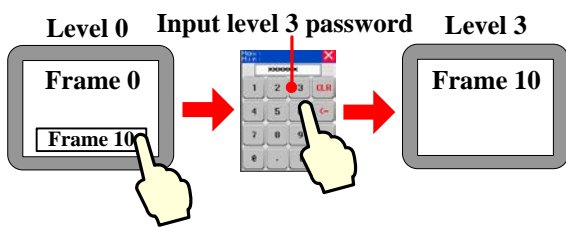
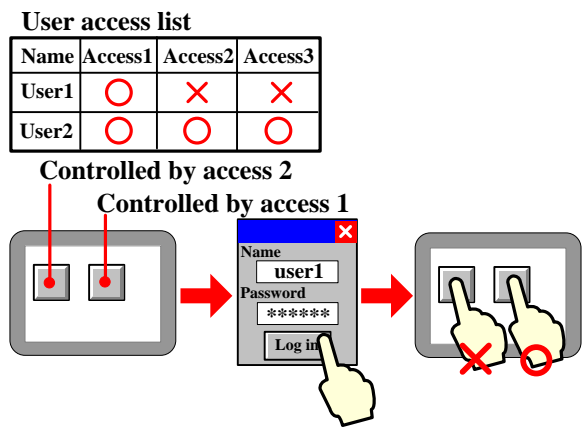
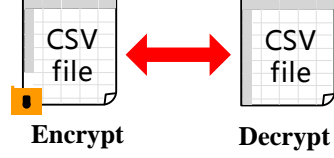
<p>Password protection for project.</p>		<p>Details please refer to [Advanced Part 10.1 Project Protection]</p>												
<p>Password protection for uploading project.</p>	 <p style="text-align: center;">After input upload password</p>	<p>Details please refer to [Advanced Part 10.1 Project Protection]</p>												
<p>Password protection for decompiling project.</p>	 <p style="text-align: center;">After input decompile password</p>	<p>Details please refer to [Advanced Part 10.1 Project Protection]</p>												
<p>Password protection for user security level.</p>		<p>Details please refer to [Advanced Part 10.2 Window Protection]</p>												
<p>Password protection for user permission.</p>	<p style="text-align: center;">User access list</p> <table border="1" style="margin-left: auto; margin-right: auto;"> <thead> <tr> <th>Name</th> <th>Access1</th> <th>Access2</th> <th>Access3</th> </tr> </thead> <tbody> <tr> <td>User1</td> <td style="text-align: center;">○</td> <td style="text-align: center;">×</td> <td style="text-align: center;">×</td> </tr> <tr> <td>User2</td> <td style="text-align: center;">○</td> <td style="text-align: center;">○</td> <td style="text-align: center;">○</td> </tr> </tbody> </table> <p style="text-align: center;">Controlled by access 2 Controlled by access 1</p> 	Name	Access1	Access2	Access3	User1	○	×	×	User2	○	○	○	<p>Details please refer to [Advanced Part 10.3.2 User Permission Protection for Components]</p>
Name	Access1	Access2	Access3											
User1	○	×	×											
User2	○	○	○											
<p>CSV file encryption</p>	 <p style="text-align: center;">Encrypt Decrypt</p>	<p>Details please refer to [Advanced Part 2.15 Data Encryption]</p>												

● External Input/ Output

Functions	Diagrams	Notes
-----------	----------	-------

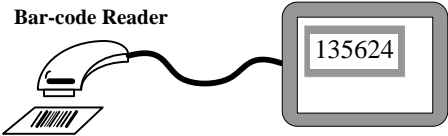
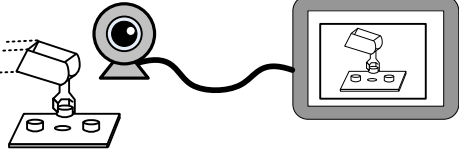
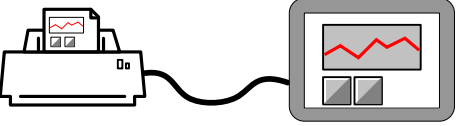
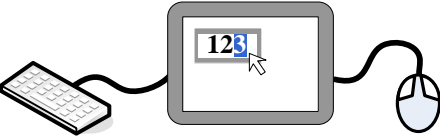
<p>Read data from barcode reader.</p>	<p>Bar-code Reader</p> 	<p>☞ Details please refer to 【HMI and PLC connection guide】 manual</p>
<p>Obtain image from video.</p>		<p>☞ Details please refer to 【Advanced Part 4.10 Video Input Component】</p>
<p>Printout the screen image or data.</p>		<p>☞ Details please refer to 【Advanced Part 13 Print】</p>
<p>Connect keyboard and mouse.</p>		

● Print Function

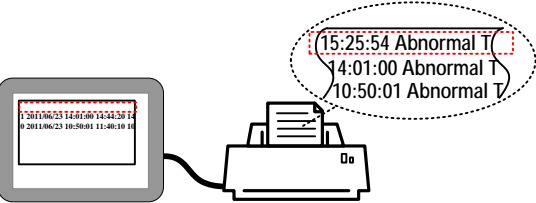
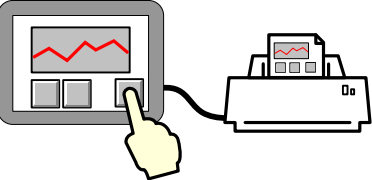
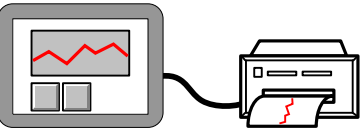
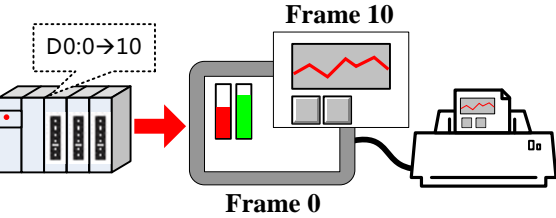
Functions	Diagrams	Notes
<p>Trigger printing event information.</p>		<p>☞ Details please refer to 【Advanced Part 4.15.3 Event Information】</p>
<p>Touch button to print screen image.</p>		<p>☞ Details please refer to 【Advanced Part 4.2.6 Function Key】</p>
<p>Print trend curve real time.</p>		<p>☞ Details please refer to 【Advanced Part 4.6.1 Trend Curve】</p>
<p>Print screen image by PLC control.</p>		<p>☞ Details please refer to 【Advanced Part 4.15.5 PLC Control】</p>

● Upload/Download

Functions	Diagrams	Notes
-----------	----------	-------

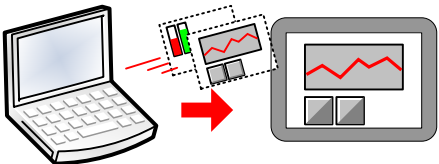
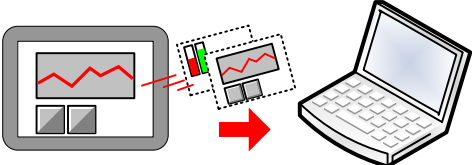
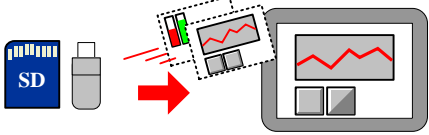
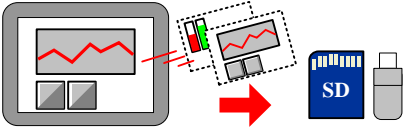
<p>Download project from PC.</p>		<p>Details please refer to 【Advanced Part 7 Compile/Simulate/Download/Upload】</p>
<p>Upload project from HMI to PC.</p>		<p>Details please refer to 【Advanced Part 7 Compile/Simulate/Download/Upload】</p>
<p>Download project from external memory.</p>		<p>Details please refer to 【Advanced Part 4.2.6 Function Key】</p>
<p>Upload project from HMI to external memory.</p>		<p>Details please refer to 【Advanced Part 4.2.6 Function Key】</p>

● Script Function

Macro

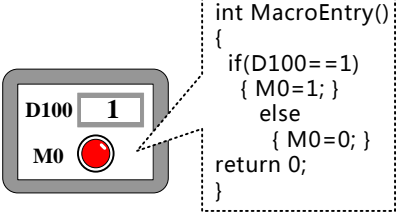
Functions	Diagrams	Notes
<p>Execute data operation or control the display in HMI by macro.</p>	 <pre>int MacroEntry() { if(D100==1) { M0=1; } else { M0=0; } return 0; }</pre>	<p>Details please refer to 【Advanced Part 9 Macro】</p>

● Other Function

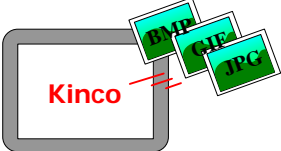
Functions	Diagrams	Notes
<p>Customize logo.</p>		<p>Details please refer to 【Advanced Part 2.8 Logo Screen (Logo)】</p>

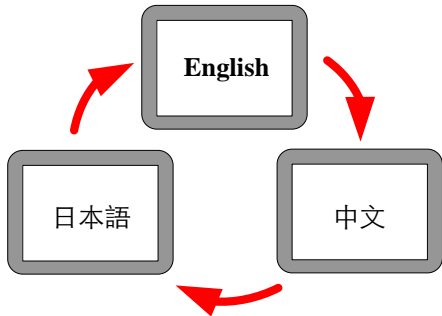
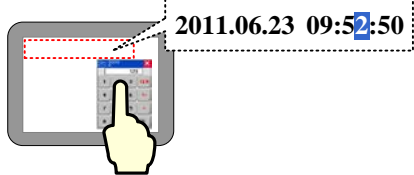
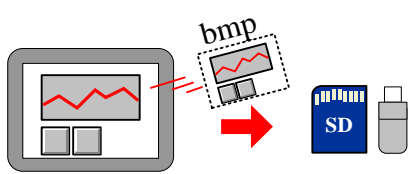
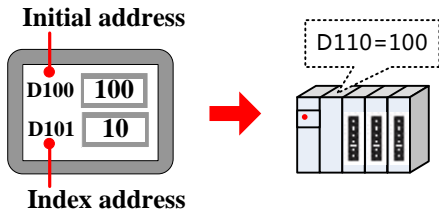
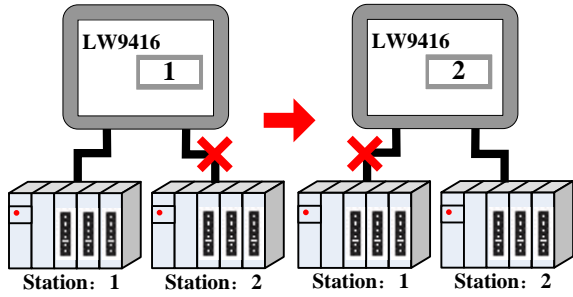
<p>Change languages online</p>		<p>Details please refer to 【Advanced Part 2.6 Language Switching】</p>
<p>Clock setting</p>		<p>Details please refer to 【Advanced Part 2.7 RTC Set】</p>
<p>Save screen by screenshot function</p>		<p>Details please refer to 【Advanced Part 4.15.5 PLC Control】</p>
<p>Index for register address(Offset)</p>		<p>Details please refer to 【Advanced Part 2.11 Index Function】</p>
<p>Index for PLC station number.(Offset)</p>		<p>Details please refer to 【Advanced Part 2.11 Index Function】</p>

2 Starting

2.1 How to use Kinco HMIware

The procedure for using Kinco HMIware is shown in following figure.

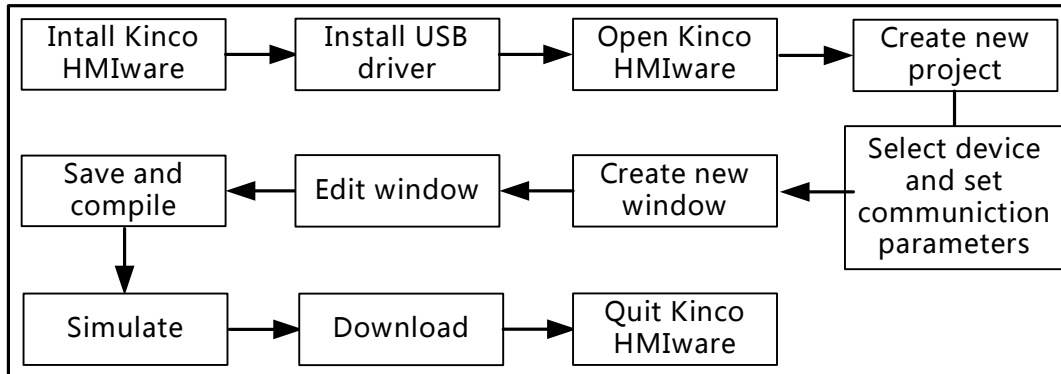

2.2 How to get Kinco HMIware software

Users can download Kinco HMIware software from download center in Kinco's website: <https://climatplc.ru/>

2.3 Kinco HMIware Installation and Operating Environment Requirement



Note for using Windows Vista/Windows 7 OS:

- When using Windows Vista/Windows 7 OS, don't install Kinco HMIware in system disk(C:).
- When using Windows Vista/Windows 7 OS, Kinco HMIware must run as administrator. Right click the icon of Kinco HMIware.exe, and then select "Run as administrator" as following figure:

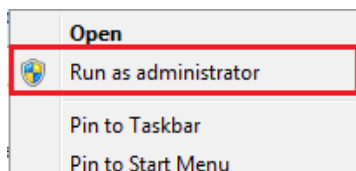

2.4 Install/Uninstall

There are two versions of Kinco HMIware (Chinese version and English version).

2.4.1 Install Kinco HMIware

The procedure of installation is as following:

Double click "Setup.exe" file to run the installation program.

- 1 Enter welcome window.
- 2 Select installation directory, the default directory is "D:\Program Files" and it will create "Kinco HMIware" folder automatically. Click **【Browse】** to change the installation directory.
- 3 Confirm installation.

It will appear installation statues of Kinco HMIware, click **【Install】** to start installing software.

4 Install successfully

If the software install successfully, then it will appear the information. Click **【Finish】** to finish installation.

After finishing installation, Kinco HMIware will create a complete startup directory in **【Start】** menu, and create the shortcut of Kinco HMIware and EVManager in desktop of operation system.

In above installation process, the user can click **【Cancel】** to quit installation.

2.4.2 Uninstall Kinco HMIware

Please quit Kinco HMIware firstly before uninstalling.

1 Run uninstall.

Method 1:Uninstall from **【Start】** menu.

【Start】 → **【All Programs】** → **【Kinco】** → **【Kinco HMIware】** → **【Uninstall】**

Method 2:Uninstall from **【Control Panel】** → **【Add/Del Programs】**

2 Uninstall procedure

Select “Remove” , click **【Next】** to start uninstalling process.

Modify Select new program features to add or select currently installed features to remove.

Repair Reinstall all program features installed by previous setup.

Remove Remove all installed features.



If there are some files or folders added in the install directory of Kinco HMIware, please delete these contents by manual after uninstalling the software.

2.5 Start/Quit

2.5.1 Start Kinco HMIware

Method 1:Start in **【Start】** menu.

【Start】 → **【All Programs】** → **【Kinco】** → **【Kinco HMIware_ENU】** → **【Kinco HMIware】**

Method 2: Double click the shortcut of Kinco HMIware in desktop to start software.

- When it is first time to start Kinco HMIware, it will display window as following:

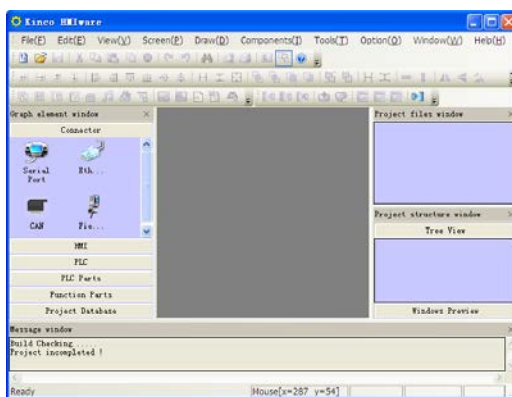

- When it is not the first time to start Kinco HMIware, then it will open the last operated project automatically.

2.5.2 Quit Kinco HMIware

After starting Kinco HMIware software, there are several ways to quit the software as follows:

- Click the **【Close】** button on the upper right side of the window.
- Click the icon of Kinco HMIware on the upper left of the window, then select “Close” in the control menu.

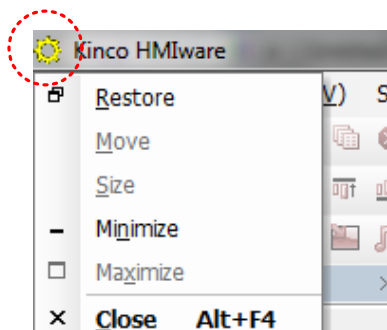

- Click Kinco HMIware **【File】** menu, then select “Quit” in the pull-down menu.
- Press **【Alt】** key and **【F4】** key on the keyboard at the same time.

2.6 System Language Change

Kinco HMIware supports switching multiple languages, user can switch the software language by the System Language of Option(O) in the software menu bar. It supports Chinese, English, Korean and Russian switching at this moment.

- Switch the Chinese version to English version



- Switch the English version to Chinese version

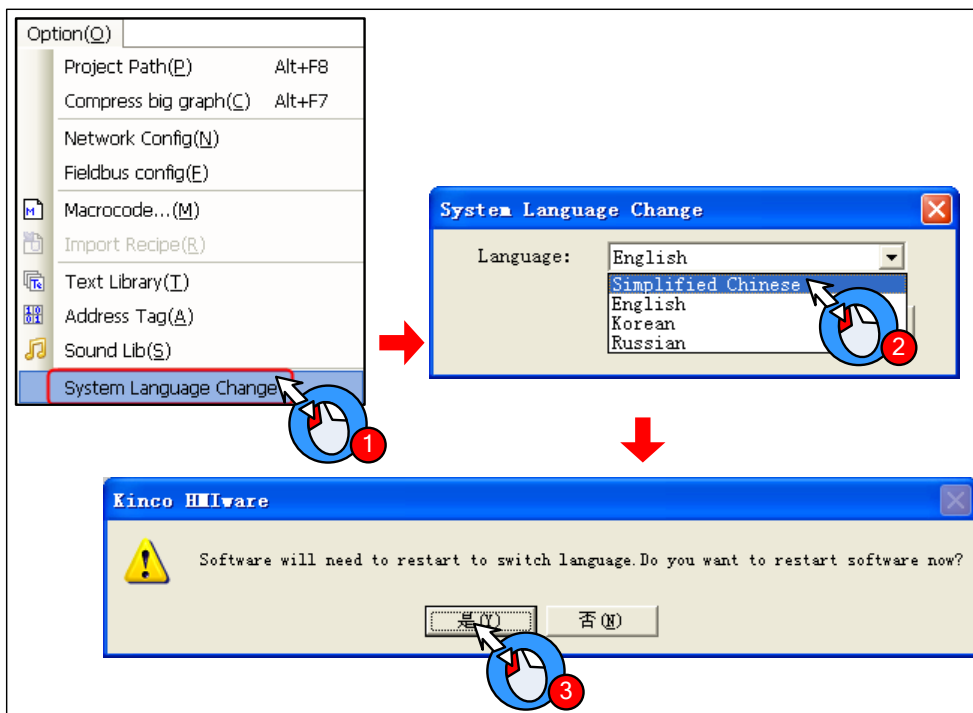

2.7 F1 Help

When user use the Kinco HMIware software, there are there methods to use the F1 help.

- Press the F1 on the keyboard
- Click the [Help] button on the component attribute
- Click the [Help] menu

2.8 Upgrade/Update



Note

1. To ensure the product working properly, it is forbidden to update, modify, uninstall and reinstall before the software is closed.
2. Before updating software, to ensure the product working properly, please uninstall the old version software completely.
3. Please backup the project made by old version software before using the new version software to update the project made by old version software.

The latest software or upgrade package can be downloaded from the download centre in Kinco' s website : <https://climatplc.ru/>

2.9 Software Compatibility



In Kinco HMIware, projects made by old version software can be opened by new version software, but project made by new version software can't be opened by old version software.

2.10 Install USB Driver



USB driver must be installed by manual, can't be installed automatically.

When it is first time to use Kinco HMIware, it need to install the USB driver for downloading HMI project.

Users can install USB driver by manual as following procedure:

- 1 Use USB cable to connect the USB SLAVE port of HMI to USB HOST port of PC, and connect the power supply of HMI

correctly and power on, then it will popup dialog box of **【Update Driver Software】**, then click “Browse my computer for driver software”:

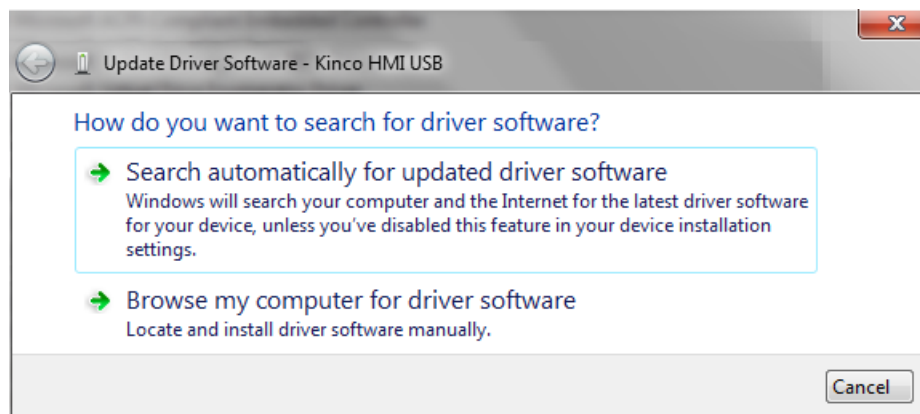

- 2 Following dialog box will display. Click **【Browse】**:

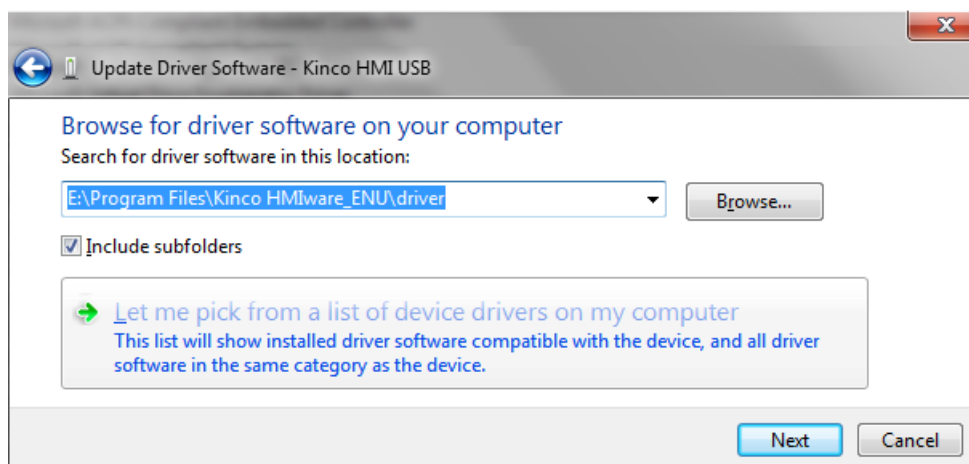

- 3 Set the route to the driver folder in the install directory of Kinco HMIware, then click **【OK】**:

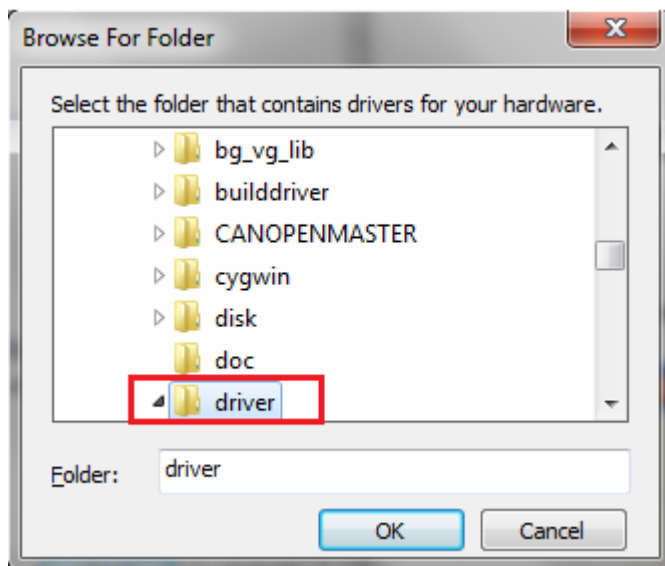

④ After finishing installation, it will popup the dialog box of “The best driver software for your device is already installed”, then click **Close** to quit.

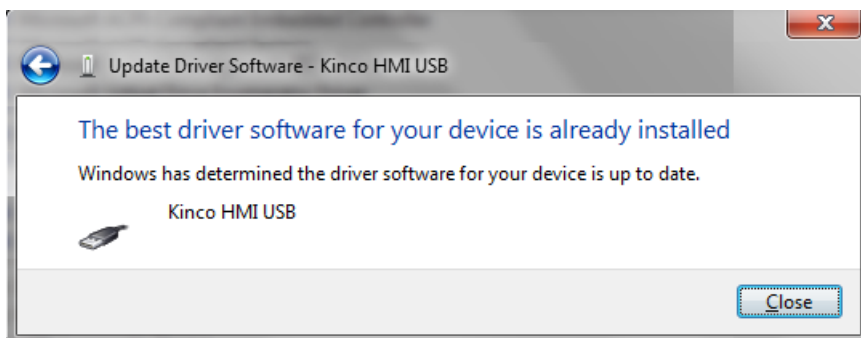

If PC doesn't popup **Installing device driver software** automatically in the first step, but there is a balloon tips in the toolbar as following figure:

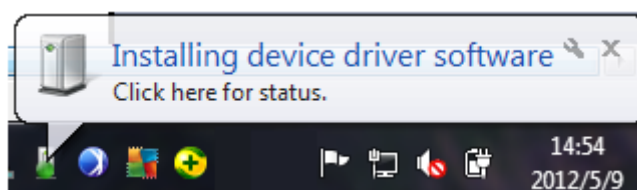

Then open **Device Manager** → **Universal Serial Bus Controllers**, there is a detection icon of unknown device. Right click the icon and select “Update Driver Software” as following figure:

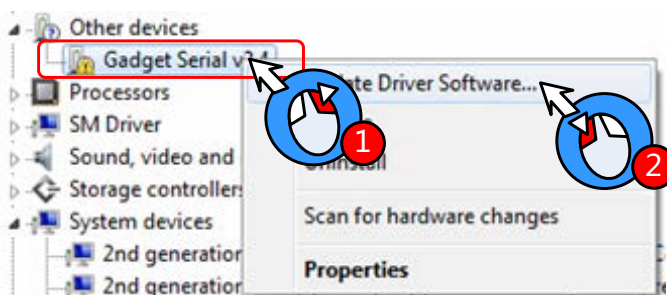

At this time, it will popup **Update Driver Software** automatically:

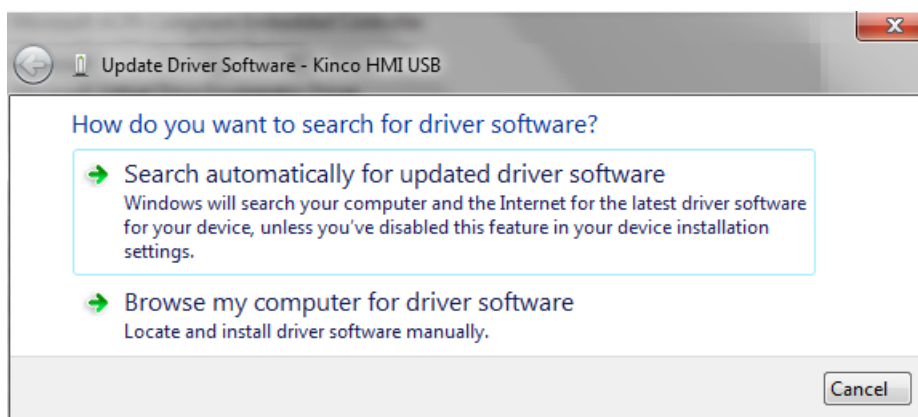

Select “No,” and click **Next**, then continue the installation procedure of USB driver as above.

After finishing installation, there is a balloon tip of “Kinco HMI USB” on the toolbar as following figure:

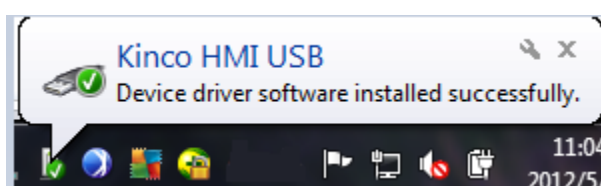

After that, open **Device Manager**, the unknown device will change to “Kinco HMI USB” in **Universal Serial Bus Controllers**. It means the USB driver installation is successful.

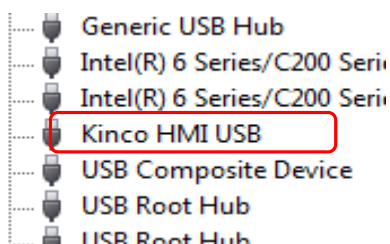

If the USB driver can't be installed correctly, there is a balloon tip on the toolbar of operation system as following figure:

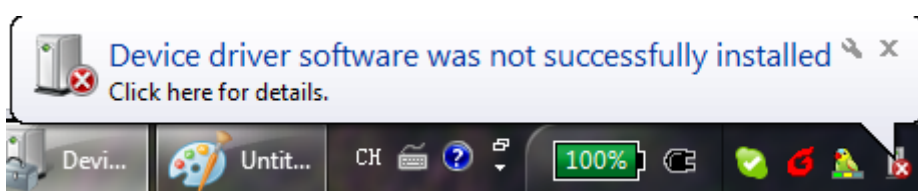









Then there is an icon of unknown device in **Device Manager**. For this problem, please select the right directory to reinstall USB driver.

2.11 Software Application Program Introduction

Kinco HMIware software is integrated with Kinco HMIware.exe, EVManager, EVPLCAddressView, RecipeEditor.exe and PDOManager and so on. Additionally, there are two manuals integrated in Kinco HMIware software. Users can find the shortcuts of these functional units in **Start** → **All Programs** → **Kinco** → **Kinco HMIware_ENU**. Their descriptions are shown in following table:

Functional Unit	Descriptions
-----------------	--------------

 Kinco HMIware	Main software which is used to create, edit, compile, simulate and download project.
 Kinco HMIware user' s manual	User' s Manual
 HMI and PLC connecting guide	Guide manual about communication between Kinco HMI and supported control devices.
 KHManager	Auxiliary software, it is used to upload, download, decompile, HMI firmware update, obtain HMI system information an so on.
 PDOManager	Auxiliary software, it is used to configure the CAN communication parameters.
 RecipeEditor	Auxiliary software, it is used to create, view or edit recipe data file and external memory data file.
 KHMonitor	Auxiliary software, it is used to monitor the HMI and PLC registers.
 Uninstall	Uninstall software; it is used to uninstall Kinco HMIware software.

3 Make Project

This chapter takes PH value of neutralization pond control system for example to explain the process of making project by Kinco HMIware.

3.1 Project Requirement

The project requires auto-control mode and manual control mode.

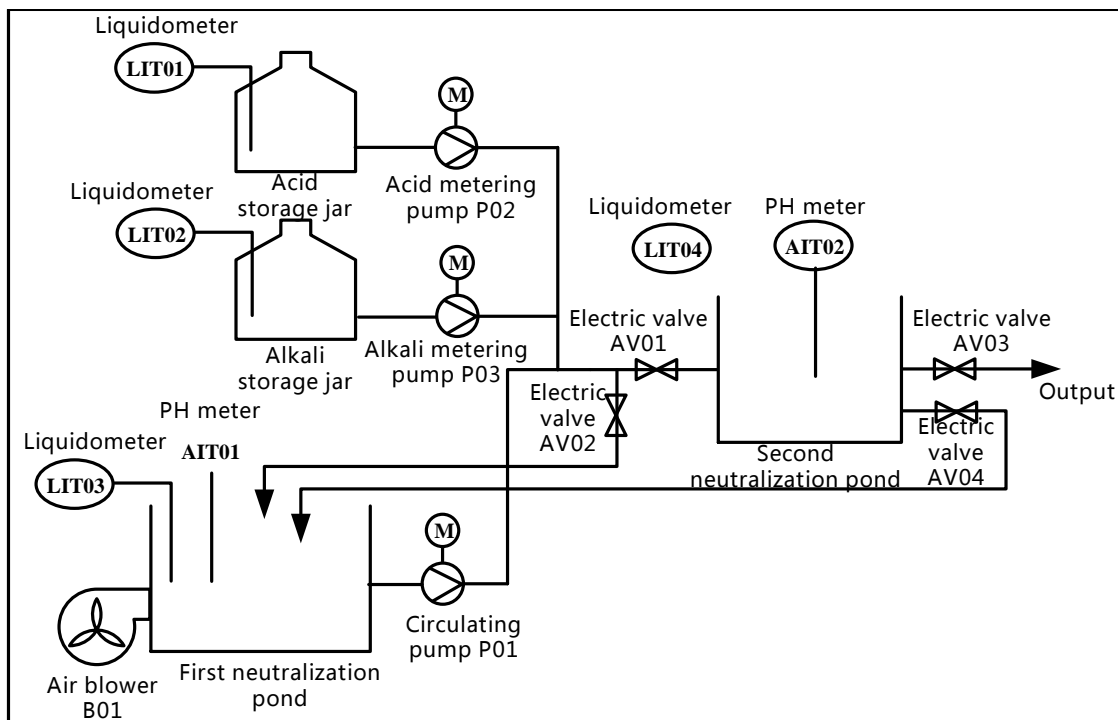

- In full-automatic control mode, after pressing “Start” button, the system will detect the water level of first neutralization pond automatically. When the liquid meter(LIT03) detect that the water level reaches preset height, then it will enter automatic circulation process: close electric valve(AV01),open electric valve (AV02),and start air blower(B01) and circulating pump(P01) to aerate and circulation stir. After stirring uniform, it will start acid metering pump(P02) or alkali metering pump(P03).When the PH value detected by AIT01 satisfies effluent standard ($6 \leq PH \leq 9$) ,then stop P02 or P03,open AV01 and close AV02,then let off the qualified water to the second neutralization pond. If the water level detected by LIT04 reaches the preset height, then it will detect the PH value of AIT02 automatically. If it satisfies $6 \leq PH \leq 9$, then close AV04 and open AV03.Let off the water until the water level detected by LIT04 is lower than lower limit, then close AV03.If it doesn’ t satisfy the requirement, then it will close AV03 and open AV04 to continue processing.

When detecting the water level of the first neutralization pond lower than lower limit, then stop B01 and P01, herein this process finish. When the water level of the first neutralization pond reach preset height, then continue to next process.

In the circulation process, LIT01 and LIT02 real time monitor the liquid level of acid storage jar and alkali storage jar.

If

it is lower than lower limit, then it will show alarm information.

- In manual control mode, every process is controlled separately by manual according to the value of AIT01 and AIT02 instead of being triggered by the water level of neutralization pond.

3.2 System Analysis

According to project requirement, this control system can be consisting of upper computer, PLC and instrumentation.

PLC is mainly used to sample data (data of liquid meter and PH meter), control device (air blower, circulating pump, electric valve). Here we use HMI as upper computer to communicate with PLC by RS-232C.

The configuration and parameters are shown in following table.

- Upper computer system configuration:

Software Kinco HMIware software

Hardware One PC with Windows XP/Vista/7 operation system and Kinco HMIware software.

One MT series HMI (Herein we choose MT5320T)

One PLC (Herein we choose Kinco CPU306EX)

One DC24V power supply for HMI

One AC220V power supply for PLC

One specified USB download cable (Herein we choose USB port for downloading program)

One RS232C cross cable for communication between HMI and PLC. (Herein we choose RS232C communication)

- PLC address allocation

Device	Address	Device	Address
Start switch SW01	I 0.0	Liquid meter LIT01	AIW 4
Emergency stop switch SW02	I 0.1	Liquid meter LIT02	AIW 6
Air blower B01	Q 0.0	Liquid meter LIT03	AIW 8
Circulating pump P01	Q 0.1	Liquid meter LIT04	AIW 10
Metering pump P02	Q 0.2	Electric valve AV01	Q 1.0
Metering pump P03	Q 0.3	Electric valve AV02	Q 1.1
PH meter AIT01	AIW 0	Electric valve AV03	Q 1.2
PH meter AIT02	AIW 2	Electric valve AV04	Q 1.3
Auxiliary relay AR01	M 0.0(Turn on when the liquid level of LIT01 is lower than lower limit)	Auxiliary relay AR05	M 0.4(Turn on when the liquid level of LIT03 is lower than lower limit)
Auxiliary relay AR02	M 0.1(Turn on when the liquid	Auxiliary relay AR06	M 0.5(Turn on when the liquid

	level of LIT01 is higher than upper limit)		level of LIT03 is higher than upper limit)
Auxiliary relay AR03	M 0.2(Turn on when the liquid level of LIT02 is lower than lower limit)	Auxiliary relay AR07	M 0.6(Turn on when the liquid level of LIT04 is lower than lower limit)
Auxiliary relay AR04	M 0.3(Turn on when the liquid level of LIT02 is higher than upper limit)	Auxiliary relay AR08	M 0.7(Turn on when the liquid level of LIT04 is higher than upper limit)

● HMI frame

Auto Control

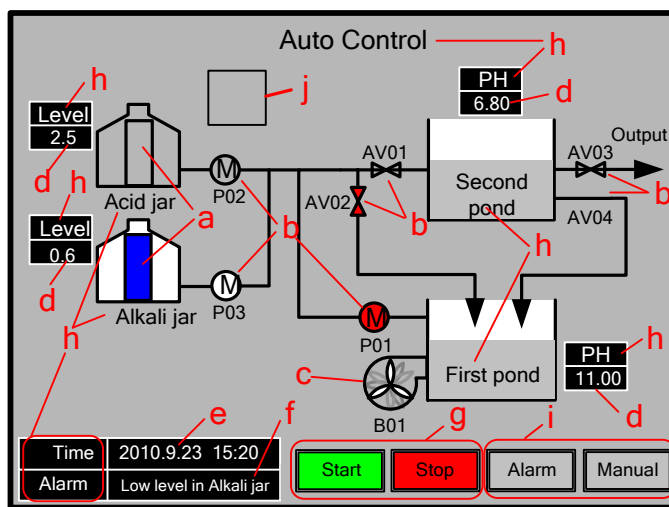

- a. Bar Graph
- b. Bit State Lamp
- c. Multiple State Display
- d. Number Display
- e. Date/Time
- f. Event Bar
- g. Bit State Switch
- h. Text
- i. Function Key
- j. Timer

Manual Control

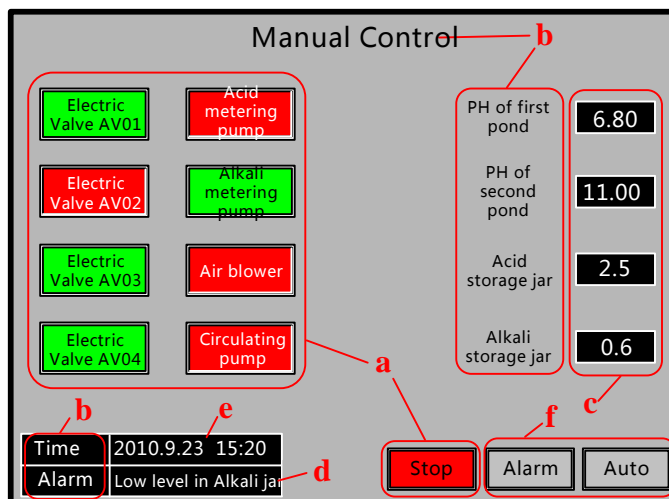

- a. Bit State Switch
- b. Text
- c. Number Display
- d. Event Bar
- e. Date/Time
- f. Function Key

Alarm Display

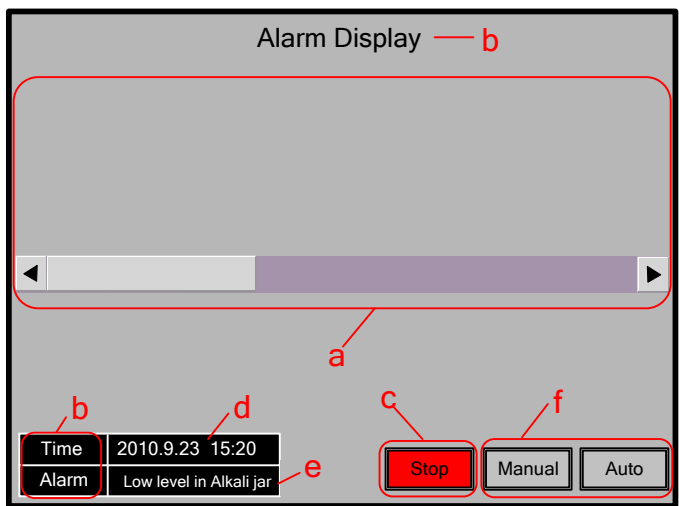

- a. Event Display
- b. Text
- c. Bit State Switch
- d. Date/Time
- e. Event Bar
- f. Function Key

3.3 Make Project

Following are the procedure for making project in Kinco HMIware.

3.3.1 Create Project

Start Kinco HMIware

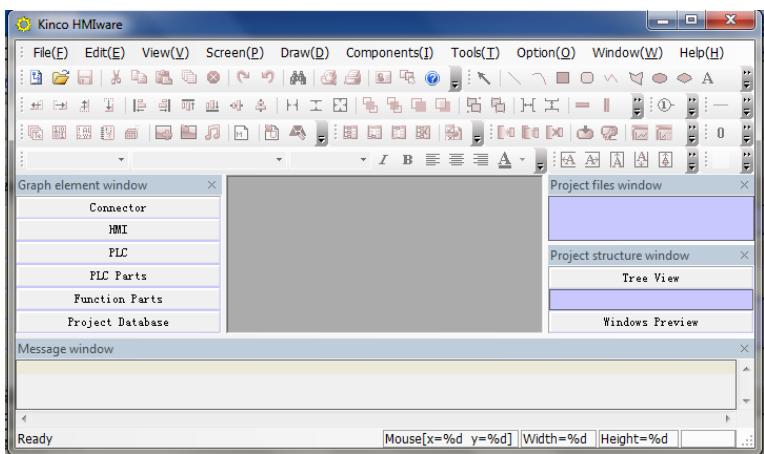

[Details please refer to \[Basic Part 2.5.1 Start Kinco HMIware\]](#)

Create Project

- ① Click the icon in toolbar to create project.
- ② Input project name. (Herein the project name is set as “PH control system”)
- ③ Select path of saving project. (Herein we use the default path)
- ④ Click **【OK】** to finish creating project.

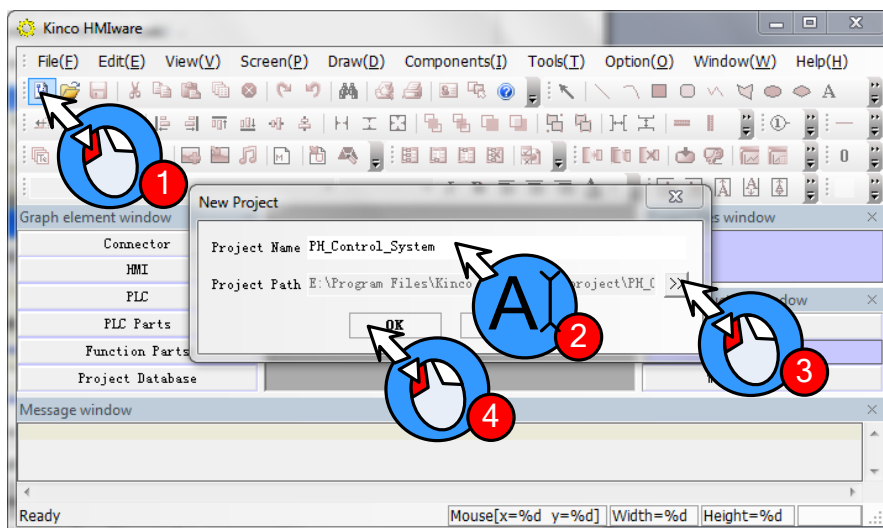

After creating project, it will popup grey grid working area. This area is named “Construct Window” .

3.3.2 Device Selection, Connection and Parameters Setting

Device selection——select communication method

Drag “Serial Port” in **【Graph element window】** — **【Connector】** to construct window.

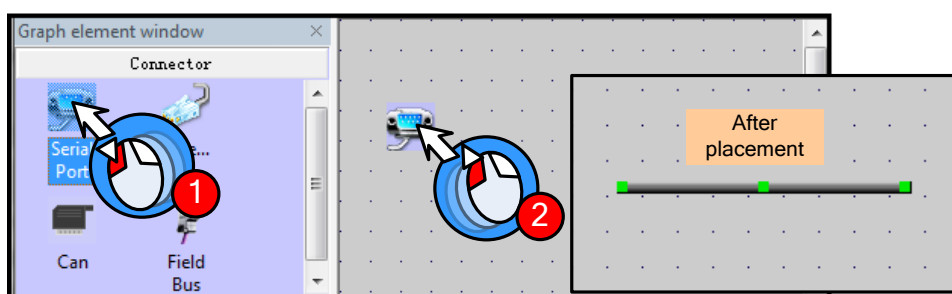

Device selection——select HMI model

Drag “MT5320T” in **【Graph element window】** — **【HMI】** to construct window.

When you release the mouse after dragging HMI icon, it will popup **【Display Mode】** dialog box as following figure. There are “Horizontal” and “Vertical” option in it.(Herein we select “Horizontal”), then click **【OK】**

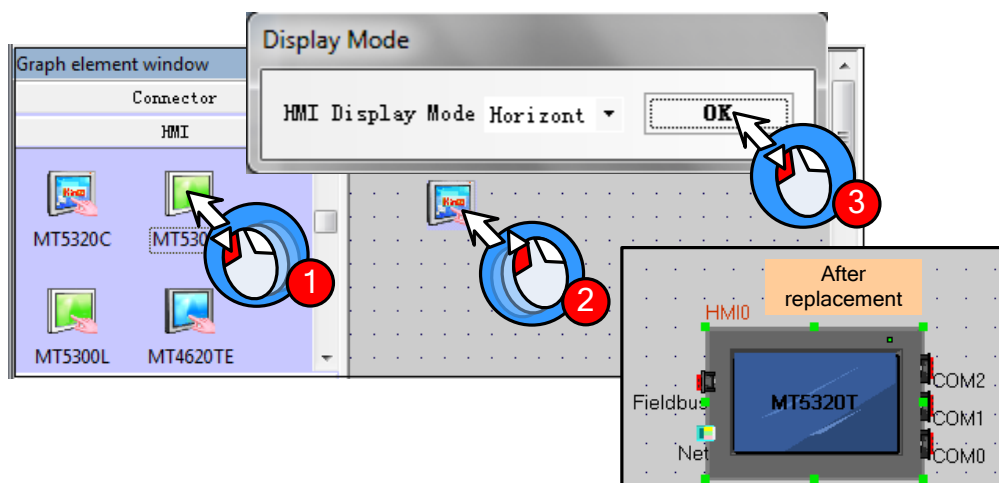

Device selection——select PLC mode (or communication protocol)

Drag “Kinco PLC Series” in **【Graph element window】** — **【PLC】** to construct window.

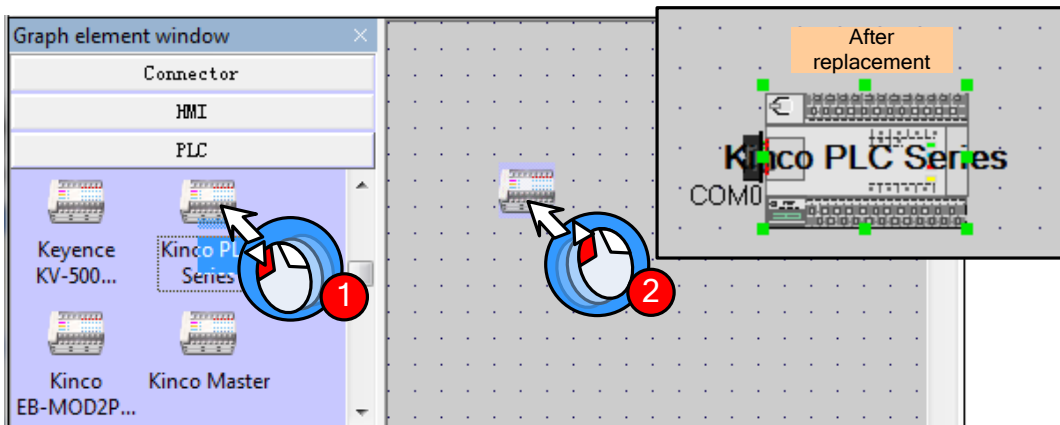

Device connection

Drag HMI icon to make “COM” port approach to the left side of connector(herein we choose COM0) until the connector moving together with HMI. Then connect PLC and connector by the same way.

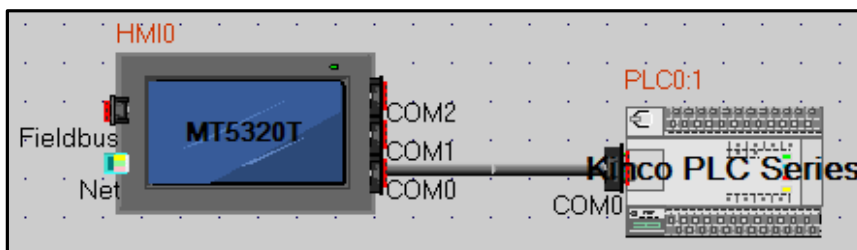

Parameters setting——HMI setting

- ① Double click HMI, it will popup window of **【HMI Attribute】**
- ② Click **【Task Bar】** option
- ③ Cancel the option of “Display Task Bar” in **【Task Bar】** (Herein we don’ t need to use "Task Bar")
- ④ Click **【COM0 Setting】** option and set the corresponding parameters of COM0 according to the communication parameters of PLC. Others all set as default.

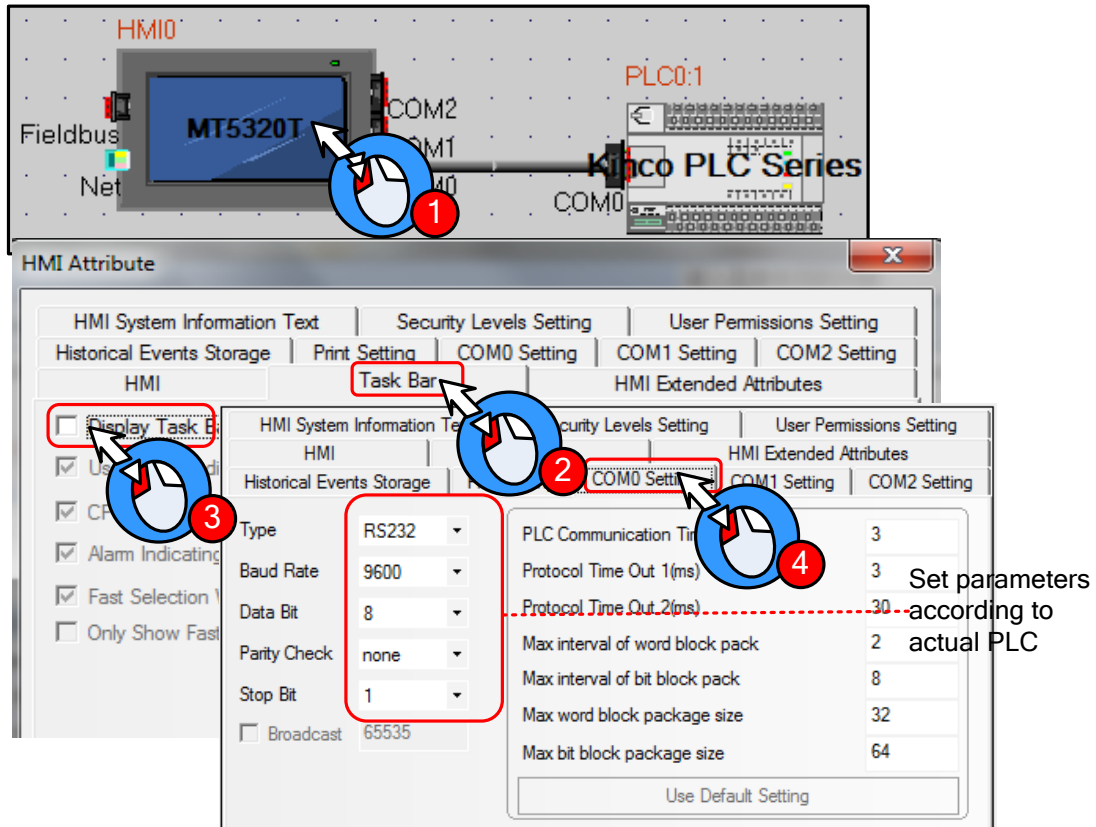

Parameters setting——slave station no. setting

- ❶ Double click PLC, it will popup 【PLC Attribute】 window.
- ❷ Set “Station No.” according to PLC’ s actual station no. (Herein the PLC’ s station no. is 1)

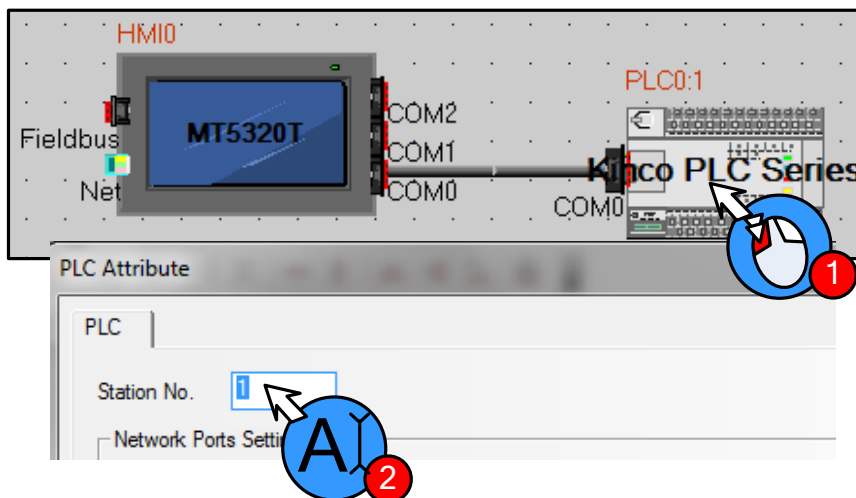

3.3.3 Edit Frame

Open HMI edit window

- 1 Right click HMI icon
- 2 Click "Edit" in the popup menu as following figure.

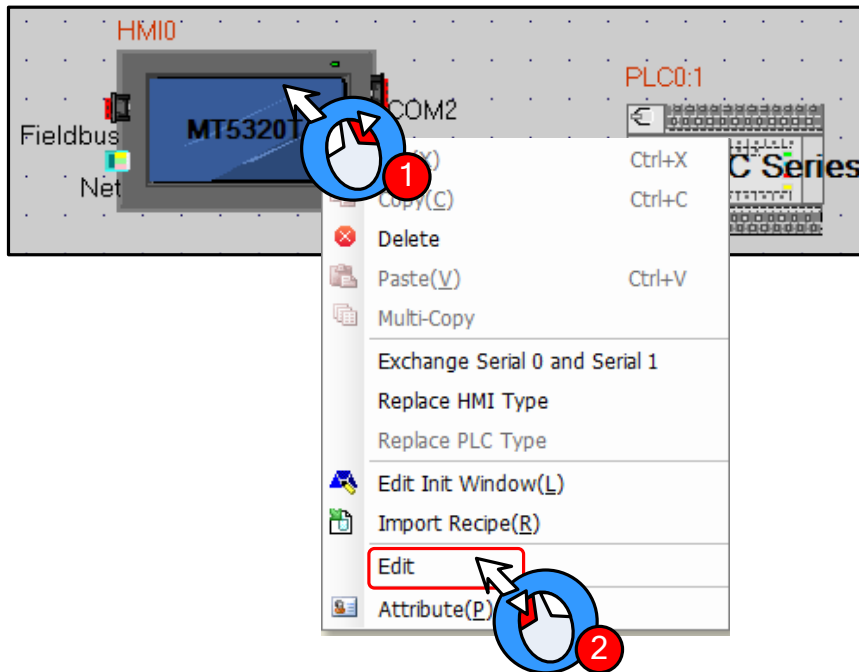

It will open HMI edit window as following figure(It will open Frame0 by default)

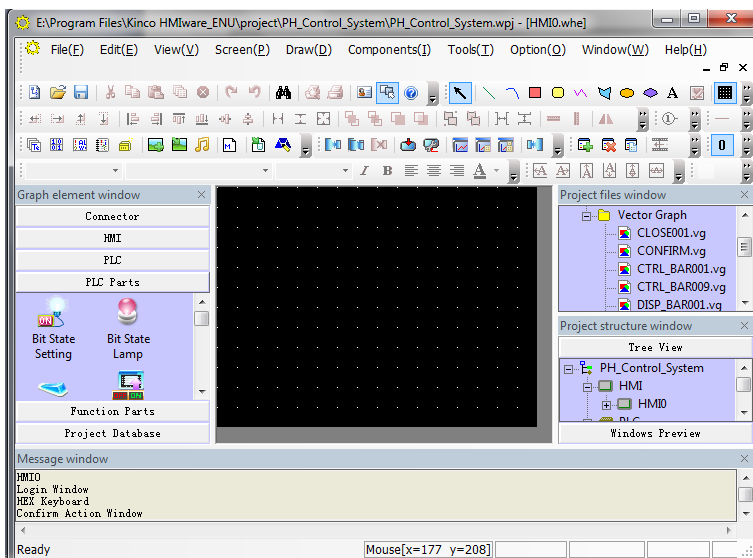

Edit frame——Create new frame

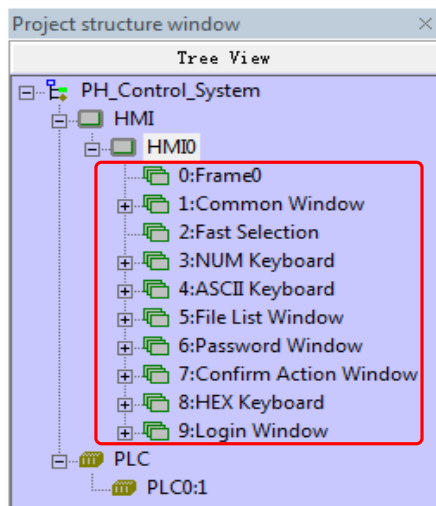

System will create frame 0~9 automatically when creating HMI. Therein, frame 1~9 are specified system windows. Only Frame0 can be used freely by user. According to the system analysis, we need to create two windows.

Procedure for adding frame:

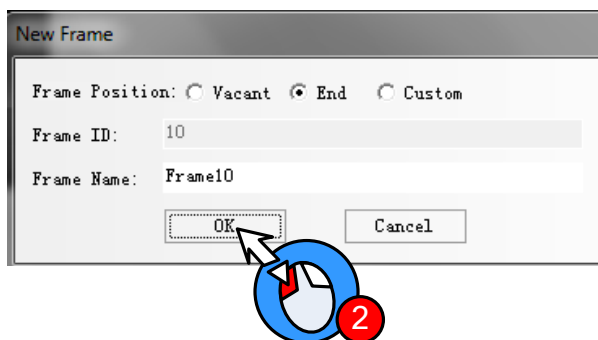
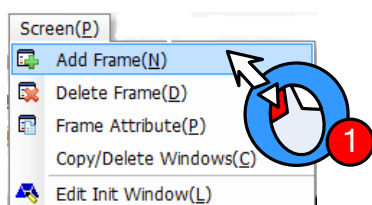

① Click **Screen** menu, select “Add Frame” .

② System will popup **New Frame** window, therein “Frame Name” can be defined freely(Herein we use system default name “Frame10”).Then click **OK** .And then create Frame11 by the same way.

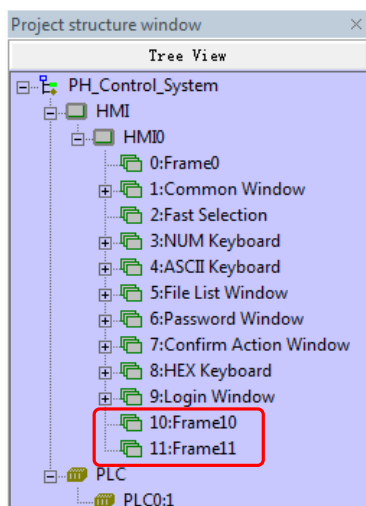

After creating new frames, they will show in **Project structure window** as shown in left figure.

Edit “Auto Control” frame——Change background color

The initial background color of windows is black (RGB : 0,0,0) .User can change the background color according to actual requirement (Herein we set the background color as light grey color (RGB : 182,182,182))

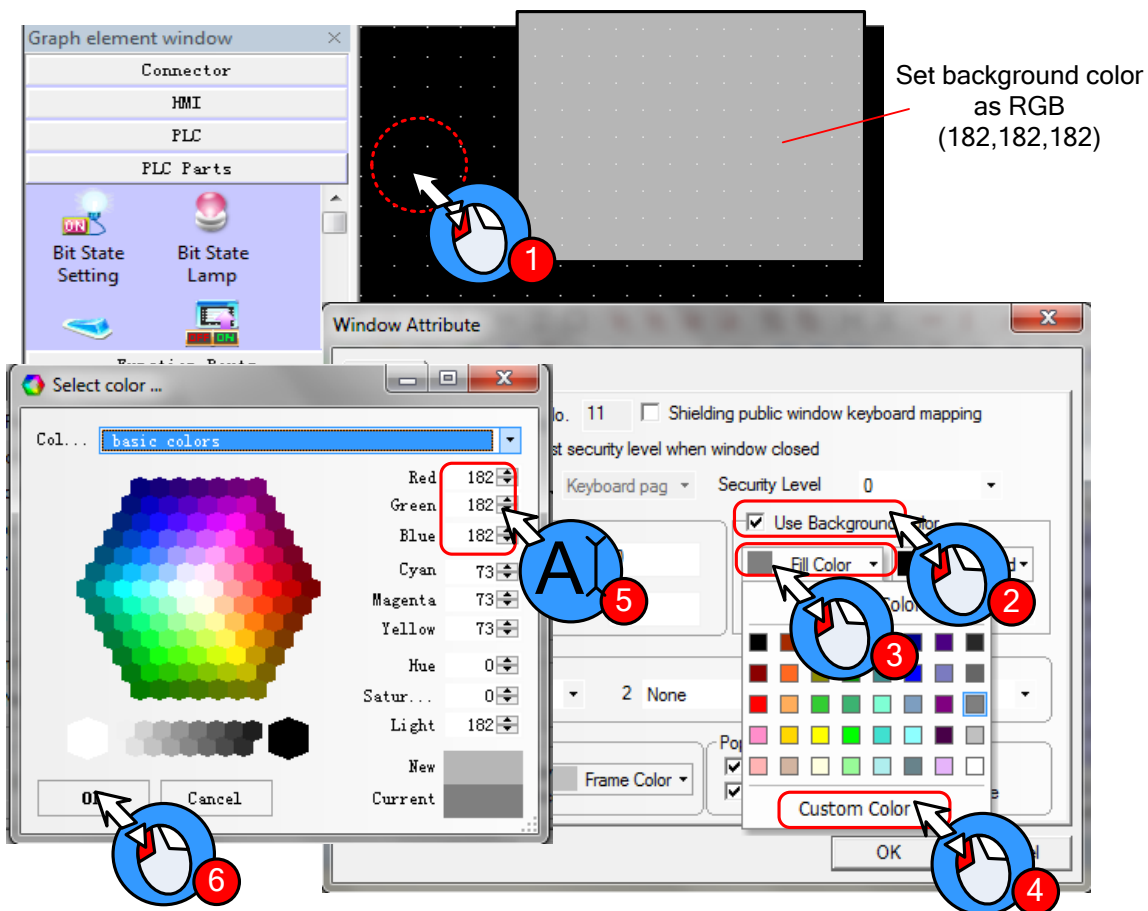

Operation procedure is as following:

- ① Double click background area, it will popup **【Window Attribute】** dialog box.
- ② Click “Use Background Color”
- ③ Click “Fill Color”
- ④ Click “Custom Color” , it will popup **【Select color】** window
- ⑤ Choose the desired color or set RGB value in Red (R) ,Green (G) and Blue (B) .
- ⑥ Finally click **【OK】**

Edit “Auto Control” frame——Edit frame title

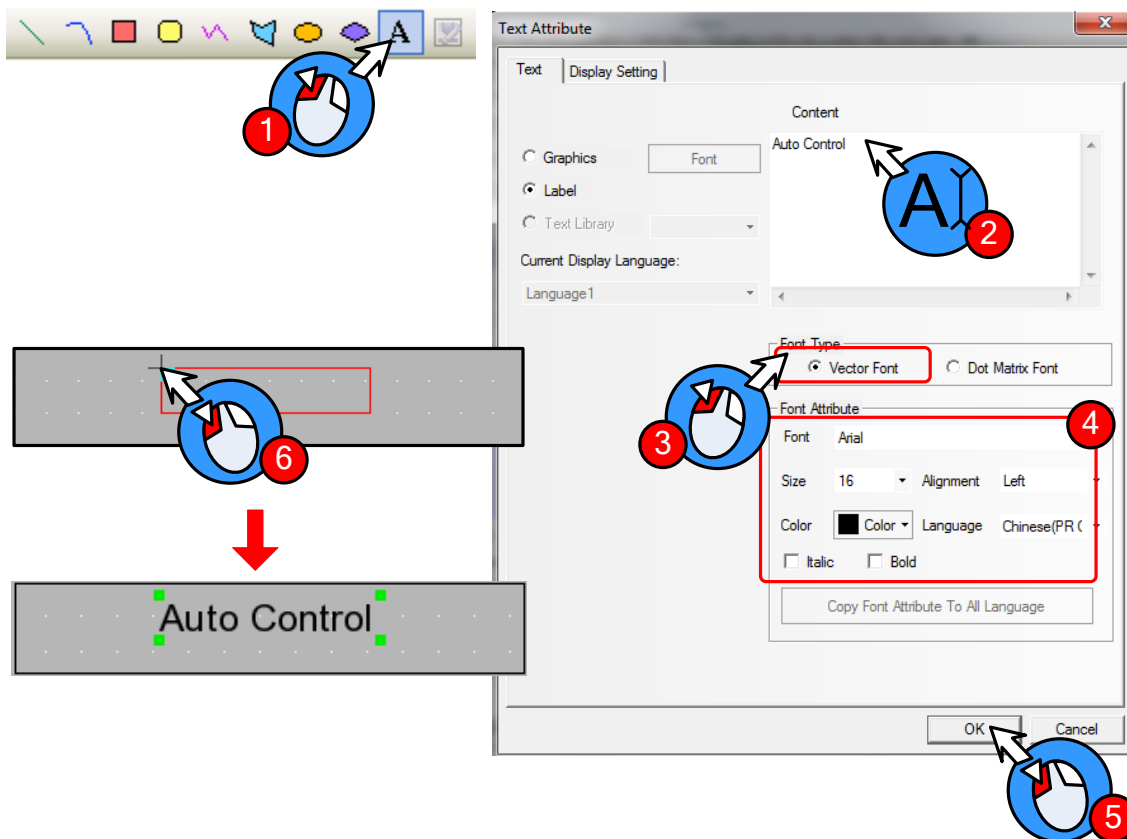

① Click **A** icon in toolbar, it will popup **【Text Attribute】** window

② Type “Auto Control” in **【Content】** area.

③ Select **【Vector Font】**

④ Setting in “Font Attribute”:

Font	Times New Roman
Size	16
Alignment	Center
Color	Black

⑤ After finishing setting font attribute, then click **【OK】**

⑥ Then there is a red box in the edit window. Choose and put on a suitable place.

Create title of “Manual Control” and “Alarm Display” by the same way.

Edit “Auto Control” frame——Draw the operation flow chart of PH control system

Draw the operation flow chart of PH control system by using line, rectangle and polygon.

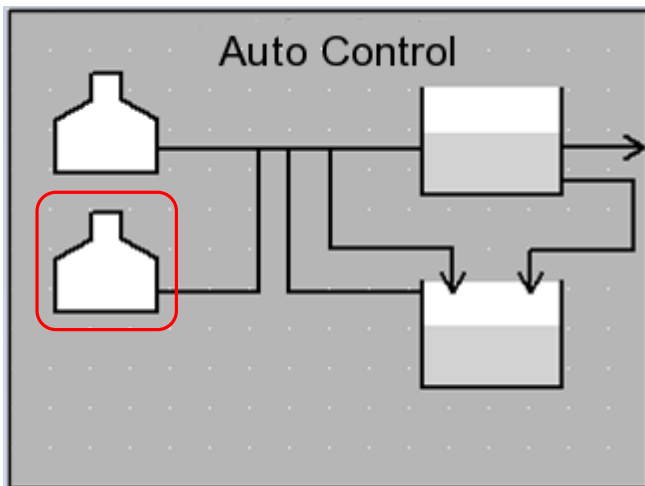

Take the graph in red box in the figure above for example, the procedure of drawing is as follows:

Click  icon in "Draw Toolbar" .



①~⑦ Move mouse to edit area, it will appear "+" .Then click 7 times on the related position.

⑧ Right click mouse to finish drawing polygon.

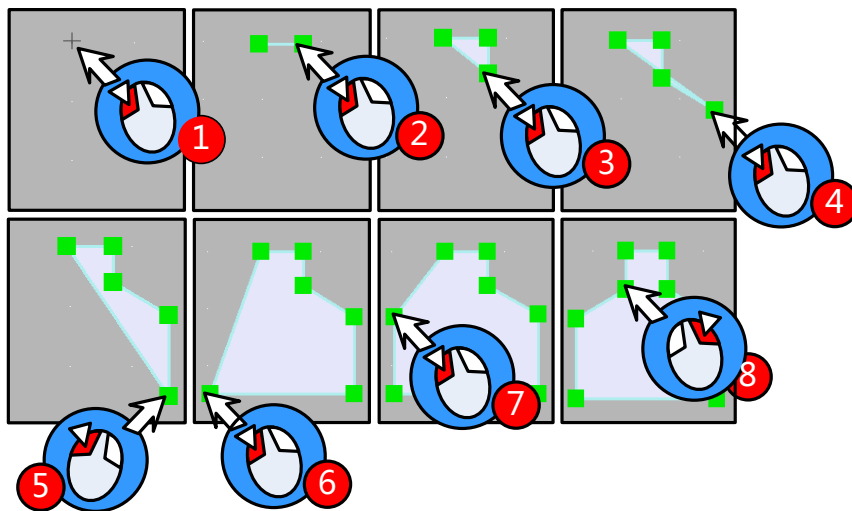

[More drawing methods please refer to 【Advanced Part 2.2 Draw】](#)

① Double click polygon to open the "Graphic Attribute" window.

② Set graphic attribute of polygon as follows :

Line Color	Black
Line Width	2 pound
Background Fill Color	White

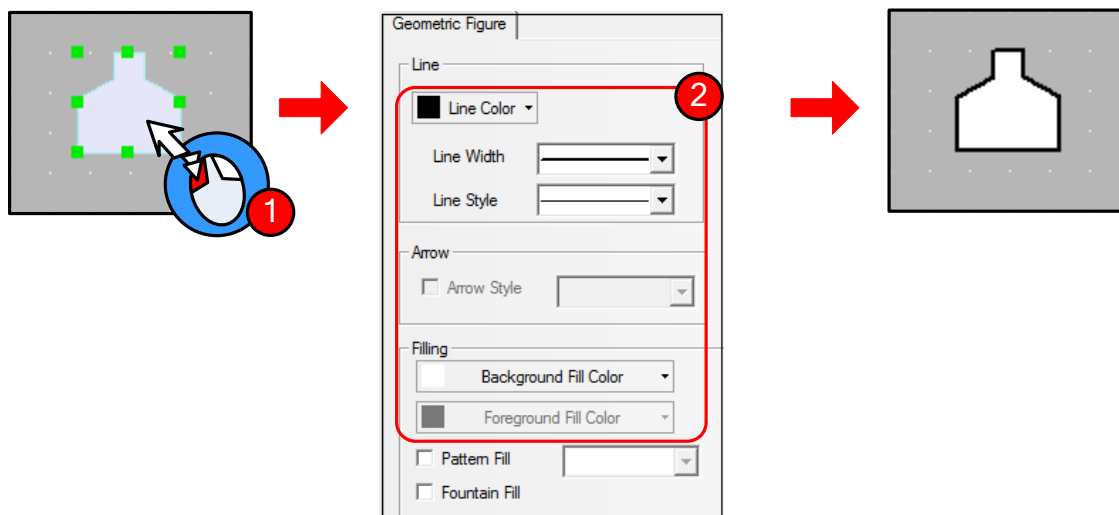

Edit “Auto Control” frame——Draw graph of metering pump

If there is no desired graph in the system image library, then user can create a new graph.

- New Graphics

- 1 Click the icon  in Database Toolbar, it will popup 【New Graphics】 window
- 2 Set the attribute as following figure
- 3 Click 【OK】 to enter edit window of vector graph

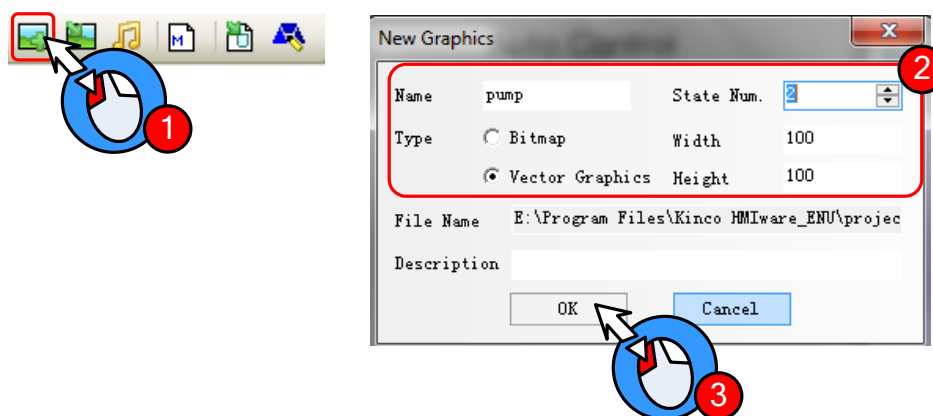

- Draw graph

- 1 Select state0 in the edit window of vector graph, click icon  in the Draw Toolbar
- 2 ~ 3 Move the mouse to the black edit area below, it will appear “+” .Then press left mouse button and drag to lower right side. Then release at the proper position to finish drawing a circle.

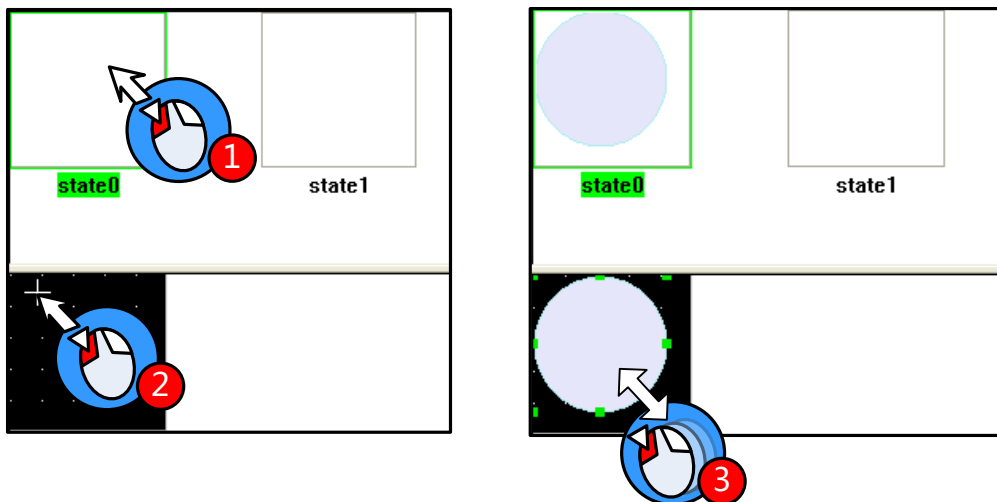

Select state1 and draw a graph by the same way as drawing state0.

[More details about new graph please refer to 【Advanced Part 5.3 Graphic Library】](#)

- Set graphics attribute

Double click the graph to open 【Graphics Attribute】 window, then set the attribute of state0 and state1.

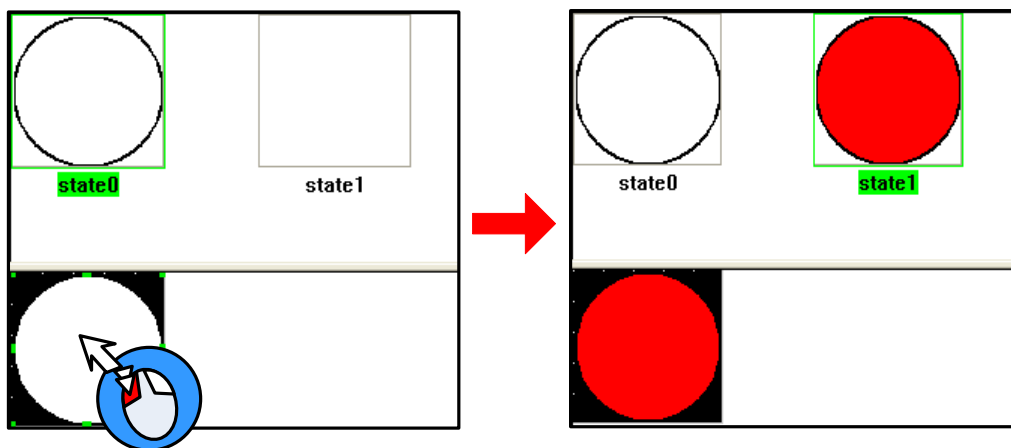

state0 Graphics Attribute

Line Color	Black
Line Width	2 Pound
Background Fill Color	White

state1 Graphics Attribute

Line Color	Black
Line Width	2 Pound
Background Fill Color	Red

- Save graph

① After finishing drawing graph of metering pump, click icon  in Basic Toolbar to save file pump.vg

② Click the icon  on the upper right of graph edit window to quit the window.

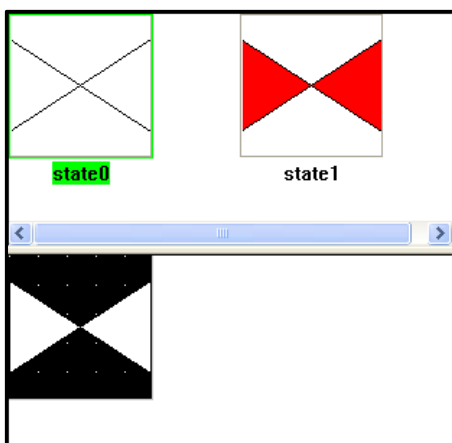
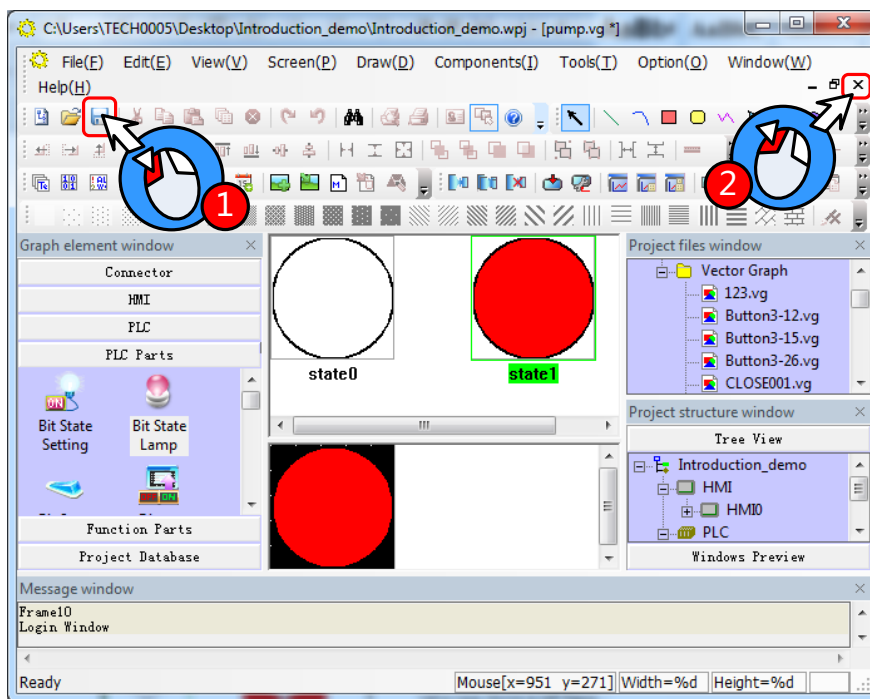

Create a new graph and draw graph of electric valve named valve.vg as shown in left figure.

Edit “Auto Control” frame—Add Bit State Lamp components (metering pump, circulating pump and electric valve)

Add 7 “Bit State Lamp” components for state indication of metering pump, circulating pump and electric valve. The procedure is as follows:

- 1 Select “Bit State Lamp” from【Graph element window】—【PLC Parts】,then press left mouse button and drag to HMI edit area.
- 2 Release mouse and it will popup attribute box of 【Bit State Lamp】

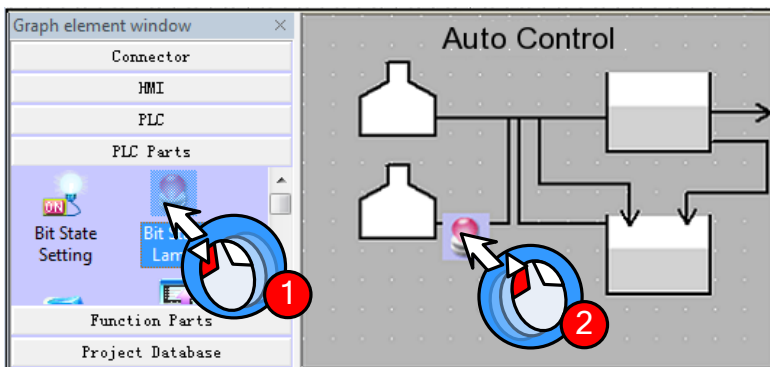

Set the components attribute as follows :

Circulating pump P01/Metering pump P02/ Metering pump P03

Read Address	Q0.1	Q0.2	Q0.3
Function	Normal		
Tag	Use; 0: M; 1: M		
Font Type	Vector Font		
Font Attribute	Arial, 11, Black, Bold		
Graph	Vector Graph: pump.vg		

Electric valve AV01/AV02/AV03/AV04

Read Address	Q1.0	Q1.1	Q1.2	Q1.3
Function	Normal			
Tag	Not use			
Graph	Vector Graph: valve.vg			

After finishing setting the components, the screen will show as following figure:

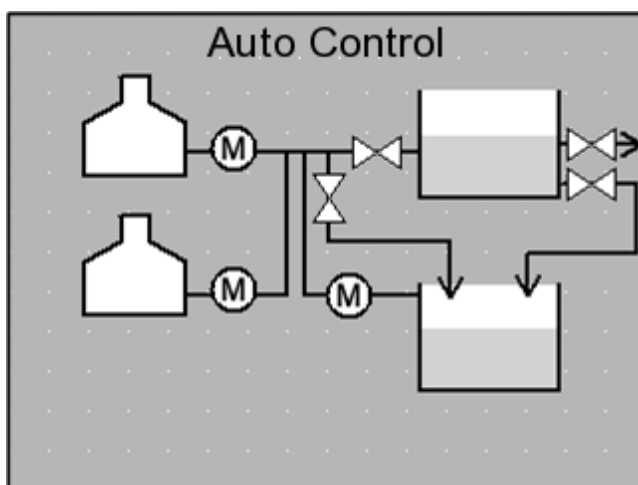

Finally add text in the screen. The procedure of adding text is the same as **【Edit frame title】**, show as following:

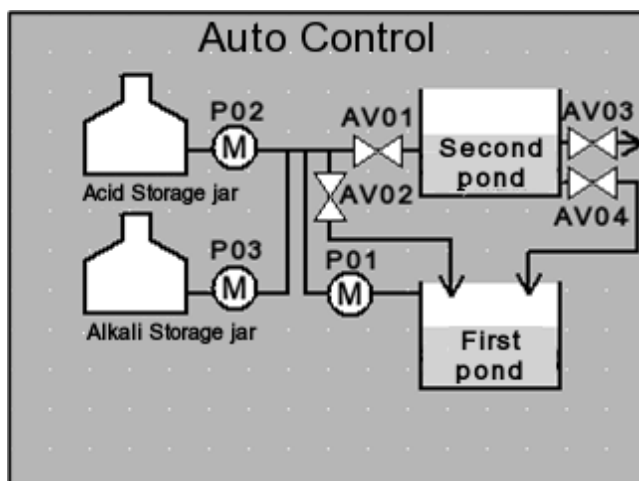

Edit "Auto Control" frame—Add Bit State Switch components (Start, emergency stop)

Add two "Bit State Switch" as "Start" and "Emergency stop" button as shown in following figure:

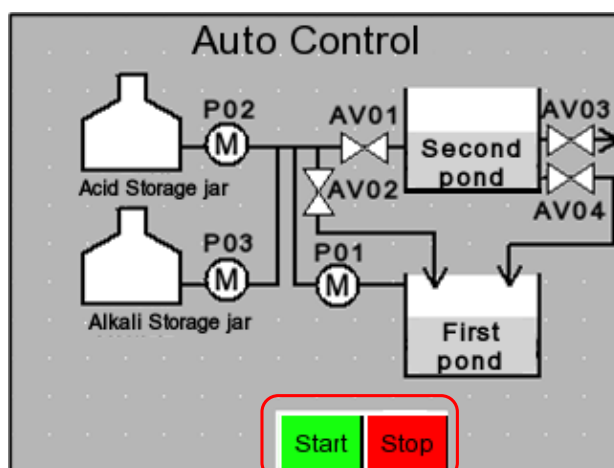

Add two "Bit State Switch" and set the attribute as follows: Start/Emergency stop

Read/Write	I0.0	I0.1
Address		
Switch Type	Reset	
Tag	Use ; 0 : Start/Emergency stop; 1 : Start/Emergency stop	
Graph	Vector Graph; Button3-15.vg* Button3-12.vg*	

*Button3-12.vg/Button3-15.vg are imported from

【System Image Library】 — 【VG】 — 【Button】

Edit "Auto Control" frame—Add Function Key components

Add two "Function Key" from 【Graph element window】 — 【Function Parts】 , which are used to change window to "Alarm Display" and "Manual Control" .

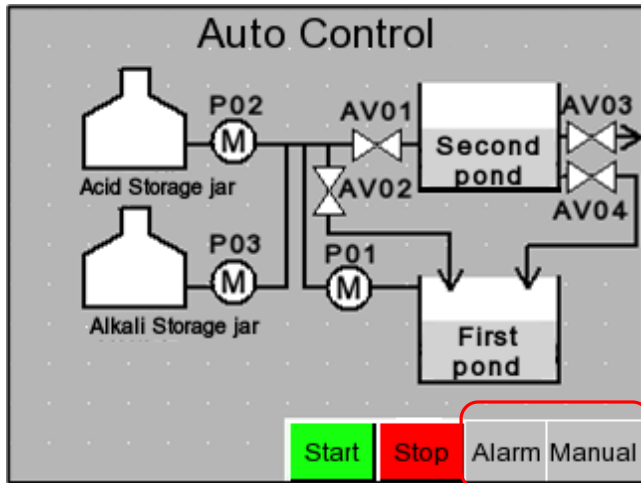

Set the attributes as follows:

Manual Control

Function Key	Change window[Frame10]
Tag	Use; 0: Manual Control; 1: Manual Control
Graph	Vector Graph: CONFIRM.vg

Alarm

Function Key	Change window[Frame11]
Tag	Use; 0: Alarm; 1: Alarm
Graph	Vector Graph: CONFIRM.vg

Edit "Auto Control" frame——Add Event Information Logon

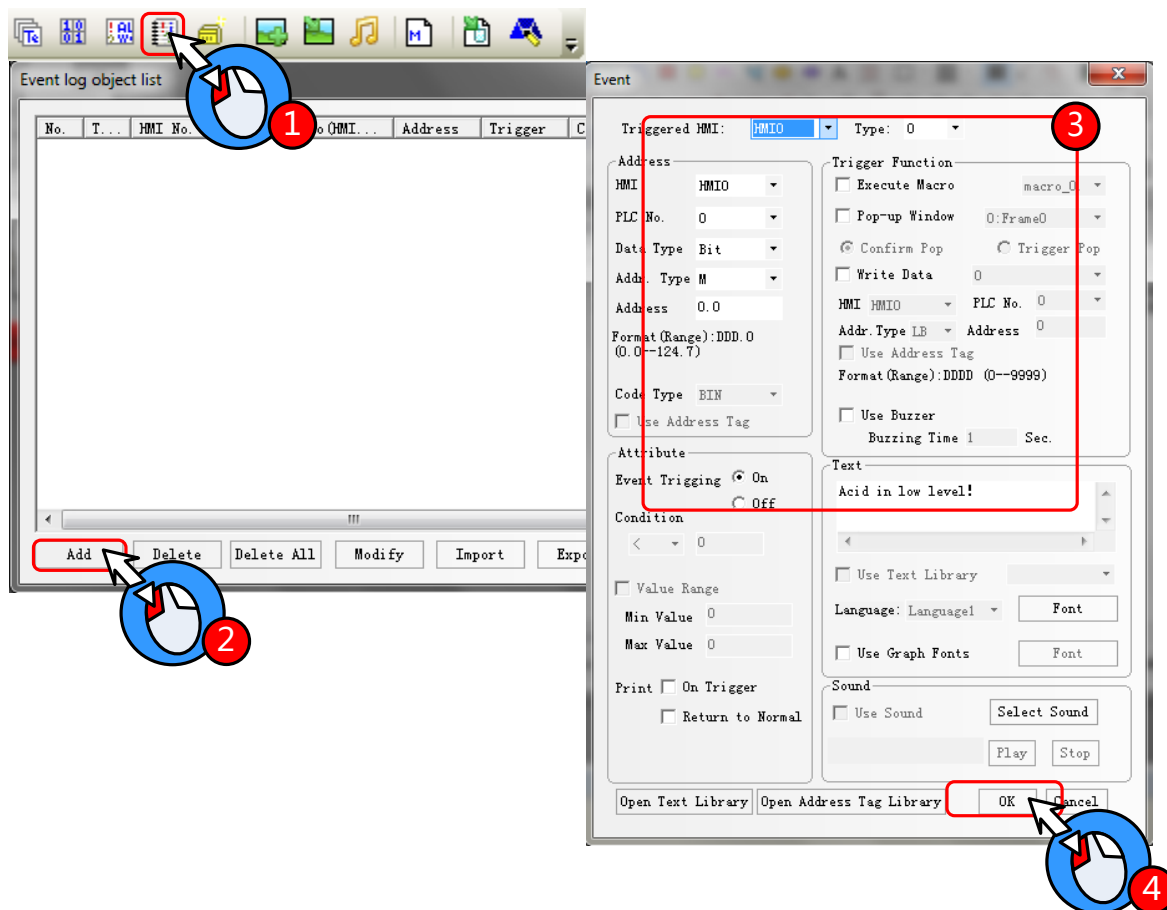

① Click icon  in Database Toolbar to open **【Event log object list】** window

② Click **【Add】** button, it will popup **【Event】** window

③ Add one event information logon as follows :

Address	M0.0
Event Triggng	On
Text	The liquid level of alkali storage jar is below lower limit!

④ Click **【OK】** button to close **【Event】** window and finish the first event information logon.

By the same way, add second event information logon.

Address	M0.2
Event Triggng	On
Text	The liquid level of acid storage jar is below lower limit!

Then click **【OK】** button to close **【Event log object list】**

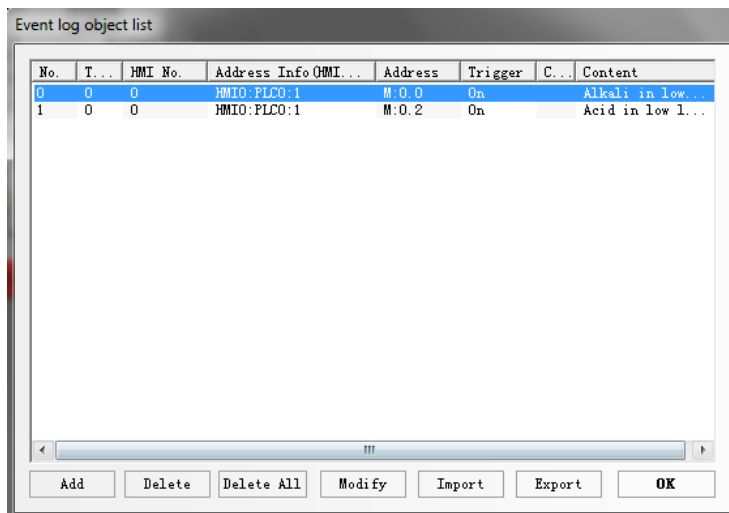

Edit “Auto Control” frame——Add information bar

Information bar include current system time and current alarm display.

Firstly add a rectangle graph and two line as background of information bar as following figure:

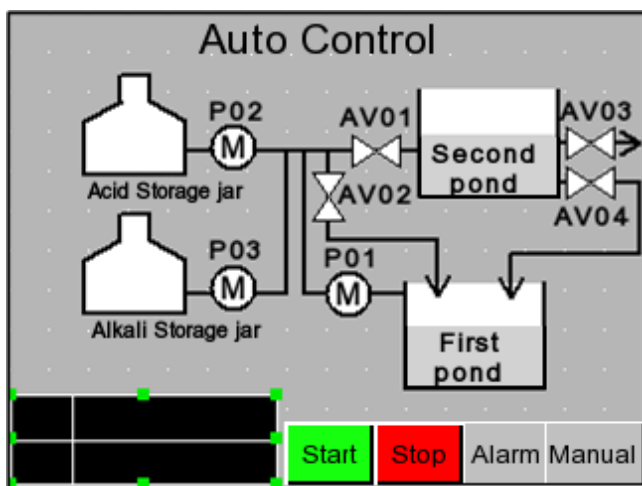

Set the attributes as follows :

Rectangle	
Line Color	White
Background Fill Color	Black

Line	
Line Color	White

[More drawing methods please refer to 【Advanced Part 2.2 Draw】](#)

Add “Date/Time” from 【Graph element window】 — 【Function Parts】 for displaying current system time.

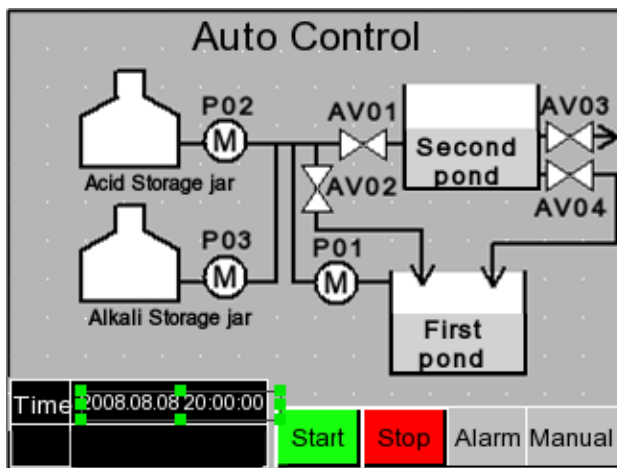

Set the attributes as follows:

Date	Display: YYYY.MM.DD
Time	Display: HH:MM:SS
Font Type	Vector Font
Font Attribute	Arial, 8, White
Graph	No use

Finally add a text of “Time” as shown in left figure:

Add “Event Bar” from **【Graph element window】** — **【Function Parts】** for rolling displaying alarm information

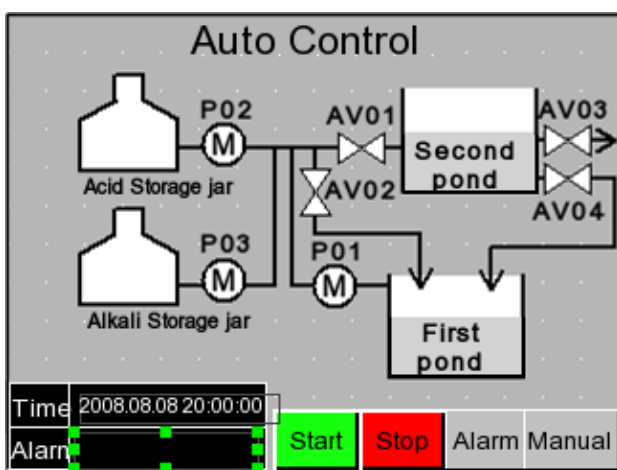

Set the attributes as follows:

Format	Event Trig Time Standard Time Format Extended Date Format Event Trig Date
--------	--

Finally add a text of “Alarm” as shown in left figure:

Edit “Auto Control” frame——Add Number Display component

Add 4 “Number Display” from **【Graph element window】** — **【PLC Parts】** for display the liquid level of alkali(acid) storage jar and the PH value of first(second) neutralization pond.

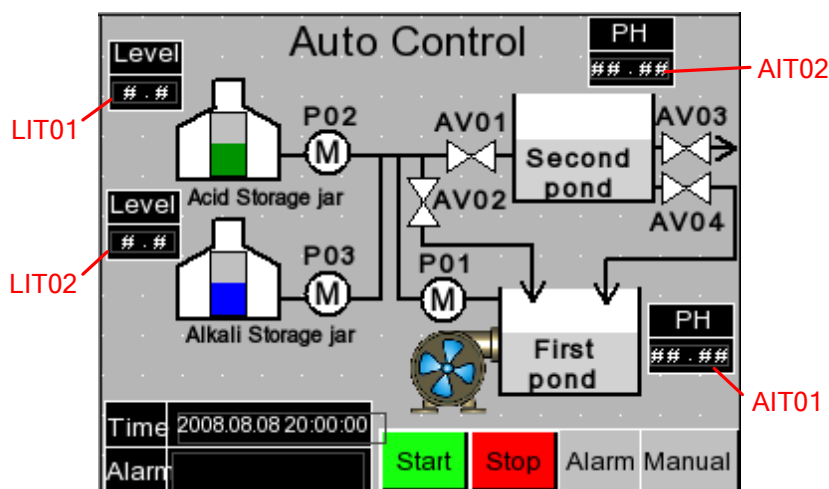

Set the attributes as follows:

PH meter AIT01/AIT02

Read Address	AIW 0	AIW 5
Data Type	Unsigned int	
Integer/Decimal	2/2	
Min/Max	0/1400	
Graph	No use	

Liquid meter LIT01/LIT02

Read Address	AIW 4	AIW 6
Data Type	Unsigned int	
Integer/Decimal	1/1	
Min/Max	0/50	
Graph	No use	

Edit “Auto Control” frame—Add Bar Picture components

Add 2 “Bar Picture” from **【Graph element window】** — **【PLC Parts】** for displaying the liquid level of alkali(acid) storage jar

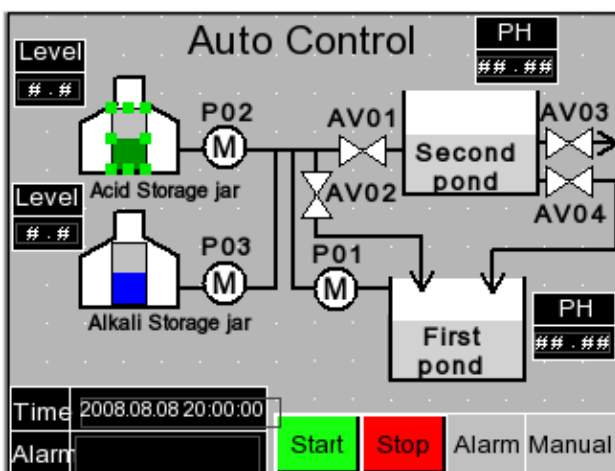

Set the attributes as follows :

Acid storage jar/Alkali storage jar

Read Address	AIW 4	AIW 6
Border Color	Black	
Normal Color	Green/Blue	
Alarm Lower/Upper	Red/Yellow	
Minimum/Maximum	0/50	
Alarm Lower/Upper	5/45	
Graph	No use	

Edit “Auto Control” frame—Add Multiple State Display and Timer components

Add one “Multiple State Display” from **【Graph element window】** — **【PLC Parts】** for displaying the rotary of fan blade of air blower.

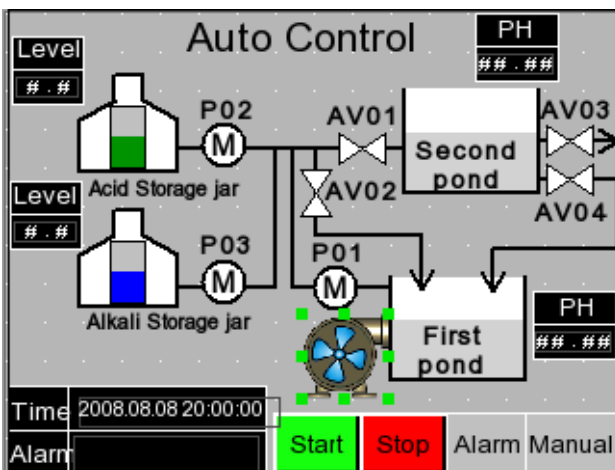

Set the attributes as follows :

Read Address	LW 0
State Num.	3
Graph	Bitmap: fan-05.bg*

*fan-05.bg is imported from **【 System Image Library】** — **【BG】** — **【Fan】**

Add one “Timer” component from **【Graph element window】** — **【Function Parts】** for changing the state value of “Multiple State Display” component.

Edit “Manual Control” frame——Add Bit State Switch components

Click “10:Frame10” in **【Project structure window】** to change window to frame10 as shown in following figure:

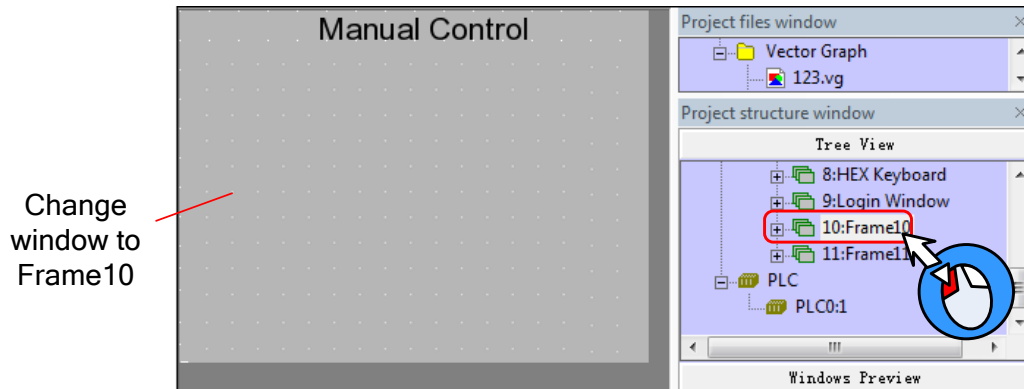

Add 8 “Bit State Switch” components from **【Graph element window】** — **【PLC Parts】** for controlling the start and stop of electric valve, metering pump, circulating pump and air blower.

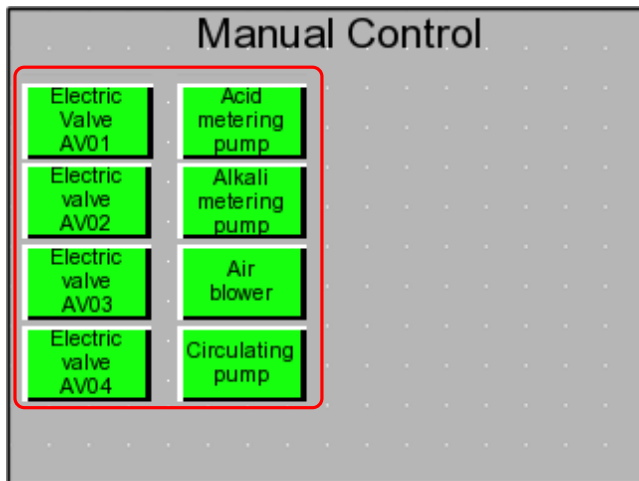

Set the attributes as follows :

Electric valve AV01/AV02/AV03/AV04

Read/Write	Q1.0	Q1.1	Q1.2	Q1.3
Address				
Switch Type	Toggle			
Tag	Use			
Graph	Vector Graphics:Button3-15.vg			

Air blower/Circulating pump/Acid metering pump/Alkali metering pump

Read/Write	Q0.0	Q0.1	Q0.2	Q0.3
Address				
Switch Type	Toggle			
Tag	Use			
Graph	Vector Graphics:Button3-15.vg			

Edit “Manual Control” frame——Add Number Display components

Add 4 rectangles as the background graph of “Number Display” components

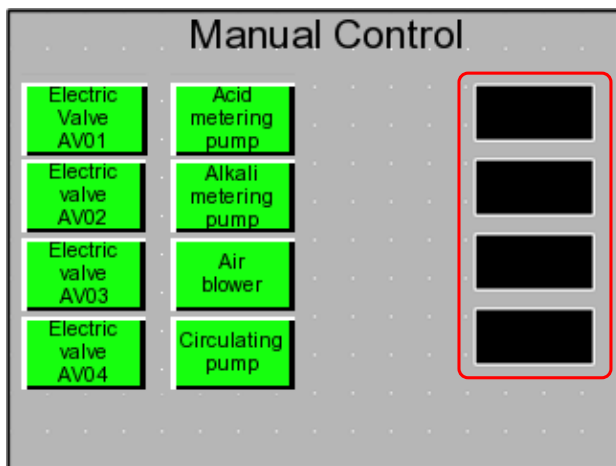

Set the attributes as follows :

Line Color	White
Background Fill Color	Black

Add 4 “Number Display” components from **【Graph element window】** — **【PLC Parts】** for displaying the liquid level of acid(alkali) storage jar and the PH value of first(second) neutralization pond

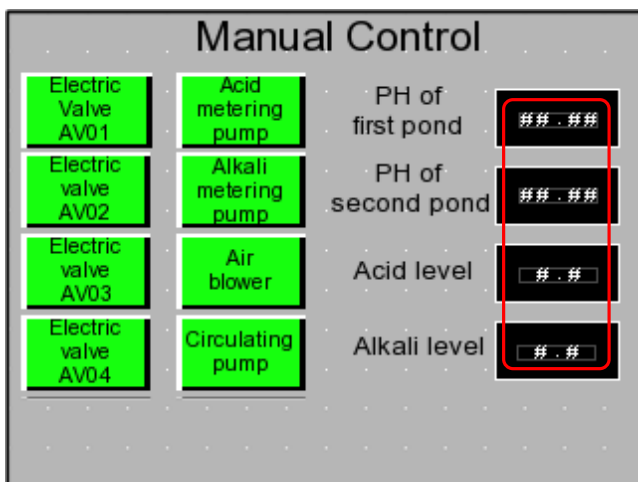

Set the attributes as follows :

PH value of first neutralization pond / PH value of Acid storage jar / Alkali storage jar second neutralization pond

Read Address	AIW 0	AIW 2
Data Type	Unsigned int	
Integer/Decimal	2/2	
Min/Max	0/1400	
Graph	No use	

Read Address	AIW 4	AIW 6
Data Type	Unsigned int	
Integer/Decimal	1/1	
Min/Max	0/50	
Graph	No use	

Edit “Manual Control” frame——Add information bar

The information bar in “Manual Control” frame is the same as “Auto Control” fram. Therefore we can copy the information bar from “Auto Control” frame to “Manual Control” frame.

- ① Select all information bars in “Auto Control” frame and right click.
- ② Click **【Copy】**
- ③ Change to “Manual Control” frame and right click.

4 Click **[Paste]**

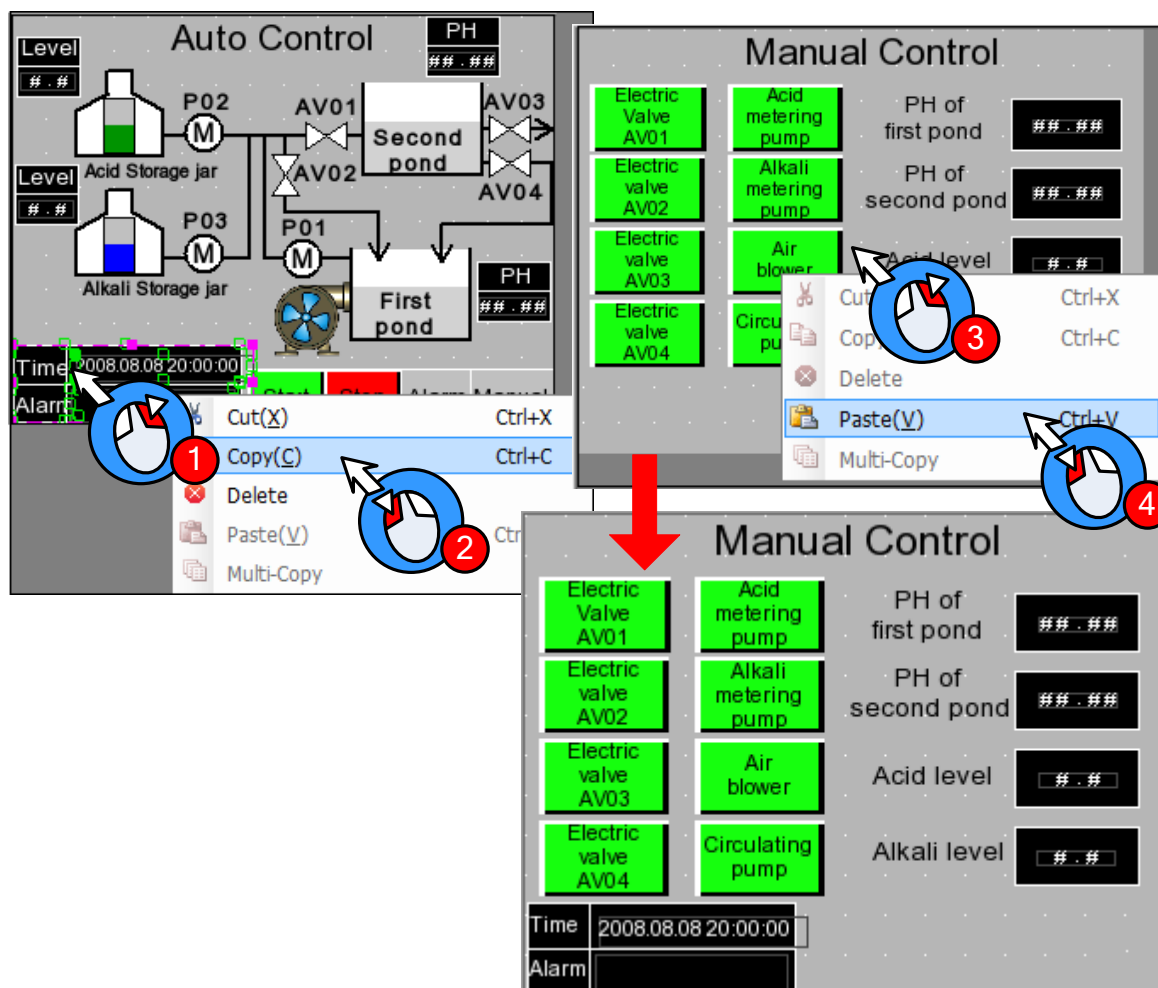

Edit “Manual Control” frame—Add “Emergency stop” button and “Change window” button

Copy the “Emergency stop” button, “Alarm” button and “Manual Control” button in “Auto Control” frame and paste in this frame.

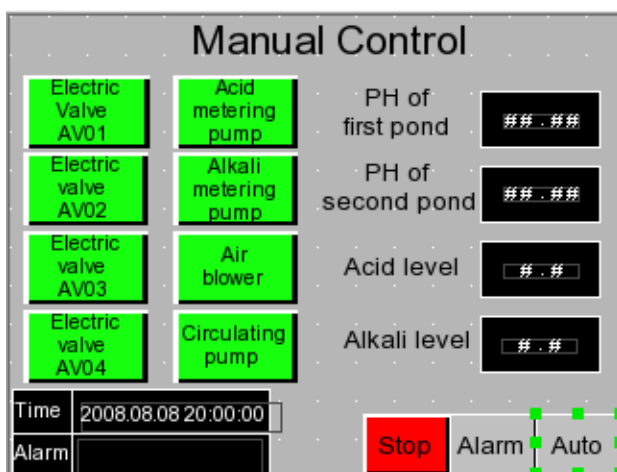

Double click “Manual Control” button to open the attribute box of **[Function Key]** and modify as follows:

Function Key	Change window[Frame0]
Tag	Use 0: Auto Control 1: Auto Control

Edit “Alarm Display” frame—Add Event Display component

Change window to Frame11.

Add one “Event Display” component from **【Graph element window】** — **【PLC Parts】** for displaying the triggered alarm information which have logined in “Event Information Logon”



Set the attributes as follows :

Read Address	LW1
Format	Sequence No. Event Trig Time Acknowledge Time Return to Normal Time Standard Time Format Extended Date Format Event Trig Date

Edit “Alarm Display” frame——Add information bar

The procedure is the same as **【Edit “Manual Control” frame——add information bar】**

Edit “Alarm Display” frame——Add “Emergency stop” button and “Change window” button

Copy the “Emergency stop” button, “Alarm” button and “Auto Control” button in “Manual Control” frame and paste in this frame.

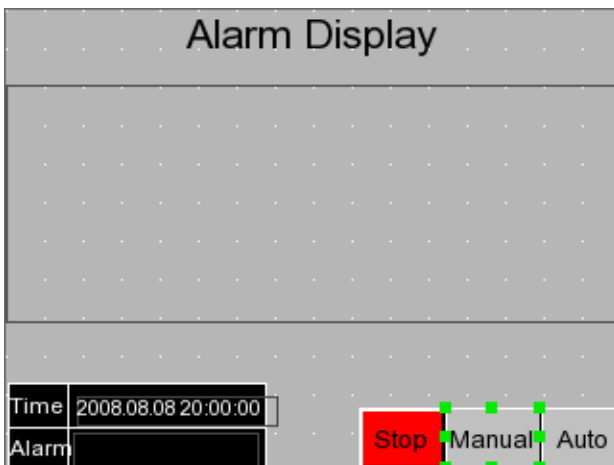

Double click “Alarm” button to open the attribute box of **【Function Key】** and modify as follows:



Function Key	Change window[Frame10]
Tag	Use; 0: Manual Control; 1: Manual Control

3.3.4 Save Project

Click the icon  in Basic Toolbar to save the project.

3.3.5 Project Simulation

After finishing project, user can simulate the project by “Off-line simulation” . The procedure is as follows:

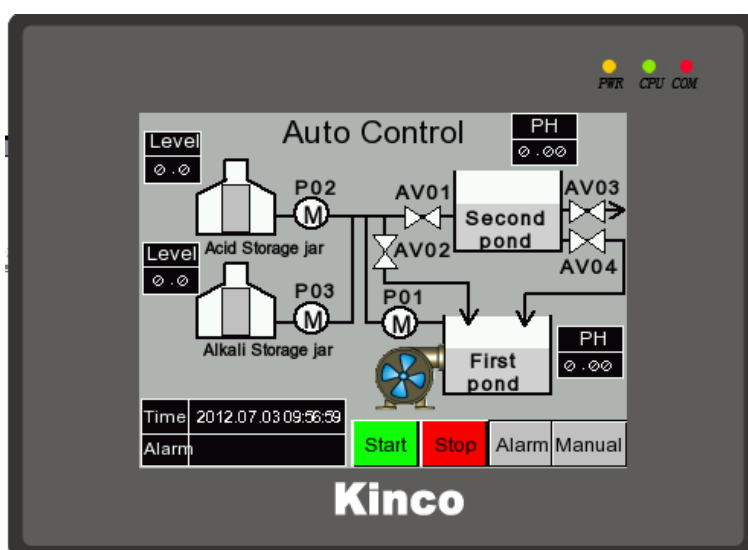

- ① Click the icon  in System Toolbar to compile the project.
- ② After compilation succeed, click the icon  in System Toolbar to popup the dialog box of **【EVSimulator】**

- ③ Select the HMI need to compile and then click **【Simulate】** button to start simulation as shown in following figure:



3.3.6 Download Project

The procedure of downloading project is as follows:

- ① Choose download way. Click the icon  in System Toolbar to open the dialog box of **【Project Setting Option】**
- ② Select “USB” in **【Download Device】** (Herein we use USB for downloading)
- ③ Click **【OK】** button to close the dialog box of **【Project Setting Option】**
- ④ Click the icon  in the System Toolbar, it will popup the dialog box of **【EVDownload】**
- ⑤ Select the HMI need to download and then click **【Download】** button to start downloading

3.4 Project Folder Introductions

When we create a new project, it will generate specified folders automatically. In these folders, it will generate some files corresponding to the operation. The instructions of the files are as following table.

Name	Instructions
HMIIn	“n” indicates number. All HMI used in one project will generate independent folder. This folder is used to store macro file and project file.
image	It is used to store initial picture of bitmap in project.
ProjBK	It is used to store the old project which is backed up by new software.
sound	It is used to store the initial file and convert file of the sound in project.
tar	It is used to store data files for project compilation.
temp	It is used to store the project which is stored at the last time.
vg	It is used to store the vector graphics and bitmap in project.
EVWindows.dat	System file
PLCGEDefaultProperties	System file
name.wpj	Project management file, opened by Kinco HMIware.
name.bak	Data file backup by system automatically

name.pkg	Data package file generated by compilation, it is used for downloading to HMI.
----------	--

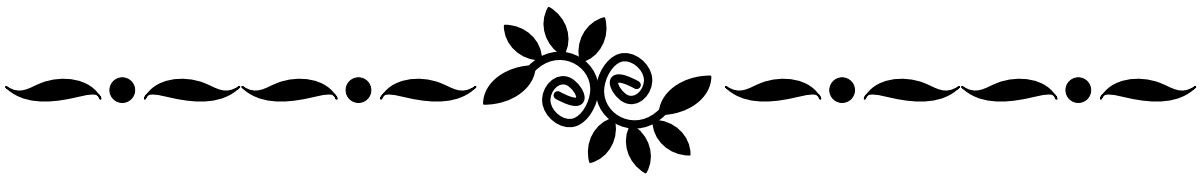

Advanced Part



1 User Interface

1.1 Interface Layout

After opening Kinco HMIware, the main interface displays as below:

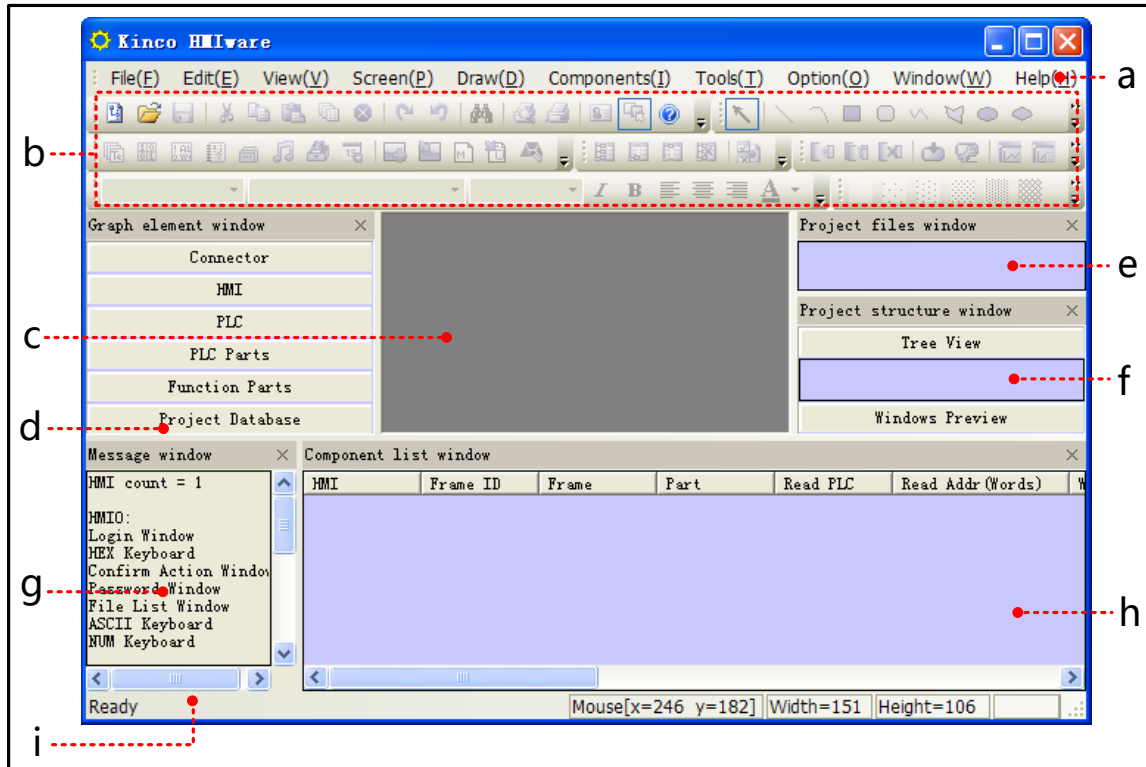

a. Menu bar b. Toolbar c. Configuration edit area d. Component library window e. Project file window f. Project construct window g. Compile information window h. Component list window i. Status bar

The main interface of Kinco HMIware is composed by the following parts:

- Menu
- Toolbar
- Software window
- Edit area

1.2 Menu

1.2.1 File Menu

- Save as: Save project to a new path.
- Project password: Set password for opening project.
- 4 files recently opened: The software automatically remembers most recently opened 4 files' name in the "File" menu to facilitate user open project directly.

Quit: Close the software, then software will prompt users to save unsaved project.

1.2.2 Edit Menu

- Undo: Cancel the latest operation, and return to the state before this operation; redo: Redo the latest operation which has been undone by the Undo operation.



Can only undo or redo one step, multiple steps of undo and redo is not supported.

- Find/Replace: Find/Replace component address or tag.
- Nudge: Left/Right/Up/Down: Move the selected component left/right/up/down by one pixel.
- Align: Left/Right/Top/Bottom/Vertical Midline/Horizontal Midline: Align the selected components.
- Size: Width/Height/Both: Set the selected components to the same width/height/ size.
- Layer: Set Top Layer/Set Bottom Layer/Previous Layer/Next Layer: Adjust the sequence of the multiple overlapped components.
- Group/Ungroup: Group/Ungroup multiple components.
- Same Horizontal/Vertical Space: Implement the equal horizontal/vertical space between multiple selected components.
- Align Horizontal/Vertical Center: Place multiple selected components in the horizontal/vertical center of the window.
- Flip Horizontally/Vertically/Rotate 90 Degree: Set the selected component to flip horizontally/vertically/rotate 90 degree.
- Select All Components: Select all the components in the frame.
- Show Grid: Display screen grid; Alignment Grid: Move by grid; Define the Grid Spacing: Self-define the screen grid space.
- Lock Component: Lock the components, then the components cannot be moved again.



The locked components support copy and paste.

- Reset Toolbar: The toolbar restore to default state.

1.2.3 View Menu

- Language: Quickly switch language 1,2,3,4.
- State: Quickly switch state 0,1,2,3.
- Zoom: 25%~300% ; Normal Size: Display in proportion of 1:1.
- Display Component' s Name: Whether or not display component' s name.
- Attribute: Attribute of window or component.

1.2.4 Screen Menu

- Add Frame: Add configuration window.

- Delete Frame: Delete configuration window.
- Frame Attribute: Open the attribute page of the current window.
- Copy/Delete Windows: Copy/Delete configuration windows.
- Edit Init Window: Edit starting up logo.

1.2.5 Draw Menu

- Static Text: Add static text
- New Graphics: Add new graphics;
- Import Graphics Library: Import graphics of the system default image library.
- Group components: Use the group element; Save the group element: Save the group component to system library. components;
- Load Image: When creating a new bitmap graphic, single click **【Load Image】** to browse and import pictures.
- Transparent Color: To make the bitmap transparent.
- Multicolor-Gray switch: Single click **【Multicolor-Gray switch】** to switch between multicolor image and grayscale image.

1.2.6 Components Menu

 [More details about components please refer to **【Advanced Part 4 Component】**](#)

1.2.7 Tools Menu

- Download Way: Selectable download way: USB/Serial port/Ethernet
- Recipe Editor: Open recipe editing window.

1.2.8 Option Menu

- Project Path: Set the default save path for project.
- Compress big graph: Compress large bitmap size to reduce project size when quantities of bitmaps are used in the project.

1.2.9 Window Menu

- Cascade: Arrange current opened windows in cascade sequence.
- Tile Horizontally: Tile current opened windows horizontally.
- Tile Vertically: Tile current opened windows vertically.
- Construct Window: Users configuration connection of HMI and PLC, as well set communication parameter in the window.
- HMI Edit Window: User editing window.
- Close All Window: Close the current opened project.

1.2.10 Help Menu

- Kinco HMIware Manual: Kinco HMIware user manual.
- Communication Connection Guide: Connection guide of Kinco HMIware communicating with various PLCs and controllers.

- Version Information: Version information of the software.

1.3 Toolbar

1.3.1 Basic Toolbar

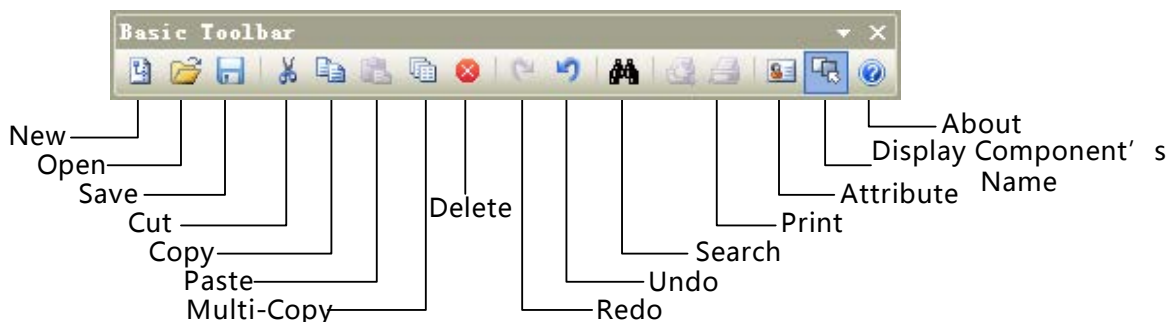

1.3.2 Draw Toolbar

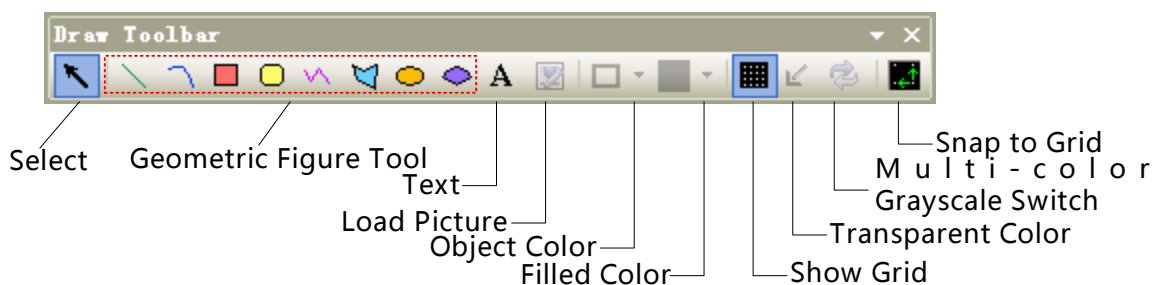

- Select: Single click **【Select】** icon to cancel the selected objects.

1.3.3 Page Switch Toolbar

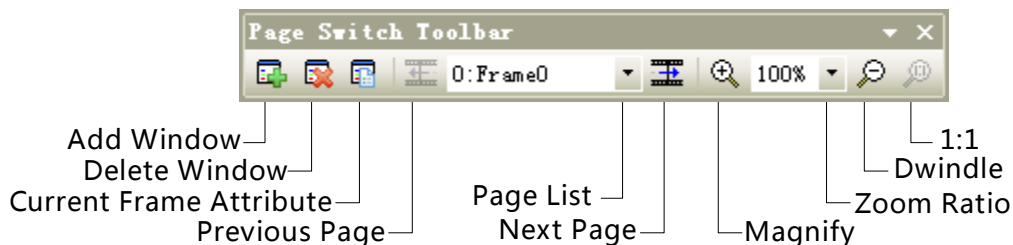

1.3.4 Position Toolbar

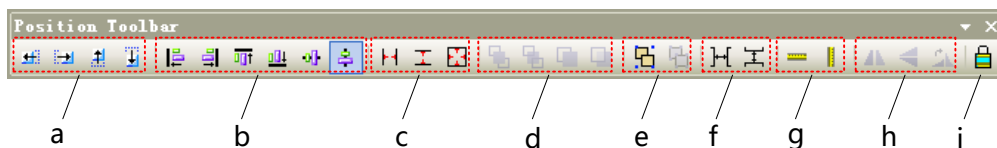

- a: Nudge Left/Right/Up/Down by one pixel
- b: Align Left/Right/Top/Bottom/Vertical Midline/Horizontal Midline
- c: Make Same Width/Height/Size
- d: Set Top/Set Bottom/Previous Layer/Next Layer
- e: Group/Ungroup
- f: Same Horizontal Space/Same Vertical Space
- g: Align Horizontal Center/Vertical Center
- h: Flip Horizontally/Vertically/Rotate 90 Degree

i: Lock Component Position

1.3.5 Line Width Toolbar



Set line width, 1~8 pounds are selectable.

1.3.6 Line Style Toolbar



Line Pattern

Arrow Pattern

1.3.7 System Toolbar

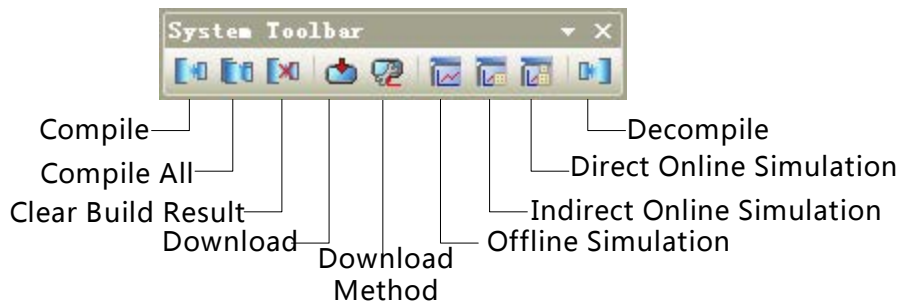

1.3.8 Database Toolbar

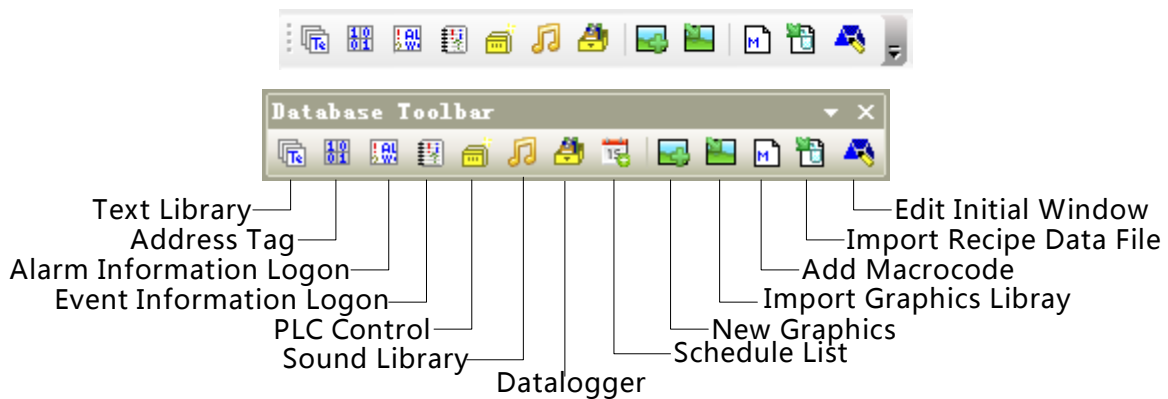

1.3.9 Code Edit Toolbar

Code Edit Toolbar: Do not support currently.

1.3.10 Fill Effect Toolbar



Fill Style 0~26

Unfilled

- Filled Style 0~26: when check **【Window Attribute】** - **【Use Background Color】**, there are 26 filled styles selectable. Filled style 0 indicates unfilled.

- Unfilled: When **【Use Background Color】** is checked, single click **【Unfilled】** to cancel fill color and filled style.

1.3.11 Label Position Toolbar



Label Position on the component

1.3.12 State Switch Toolbar

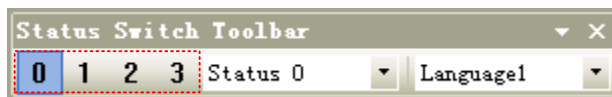

Quick Switch Status 0~3 Switch Status 0~255 Switch Language1~32

1.3.13 Font Toolbar



Dot Matrix Font/Vector Font/Bitmap Font

Font

Font Size

Italic

Bold

Align Left

Center

Align Right

Font Color

1.3.14 Status Bar

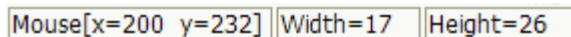

- **【Status Bar】**: Shows the current X, Y coordinate values of mouse position, width/height of the target object.

1.3.15 Tip Text

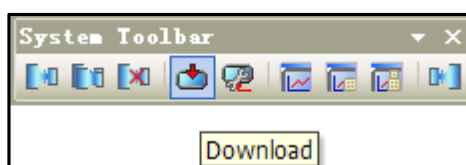

- **【Tip Text】**: When mouse is hovering over toolbar icon, the responding tip text will display.

1.3.16 Toolbar Options

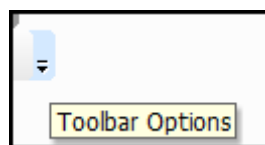

- **【Toolbar Options】**: Single click the down arrow **【Toolbar Options】**, **【Display/hide panel】** will display for user to start closed toolbars.

1.4 Software window



Kinco HMIware software windows include: Graph element window, Project files window, Project structure window,

Message window, Component list window.

1.4.1 Graph Element Window

Graph element window is one of the most indispensable windows, which is mainly for supply configuration with devices, components and other design elements.

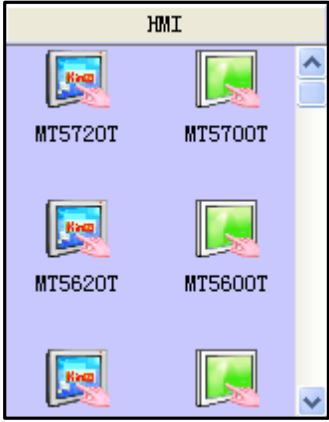
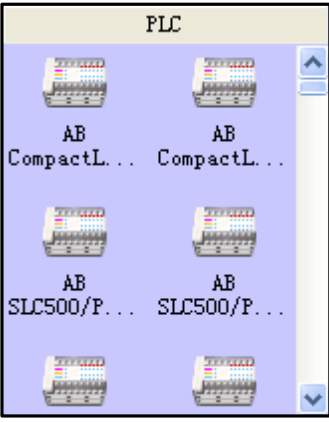
Graph element window is composed of the following 6 element libraries:

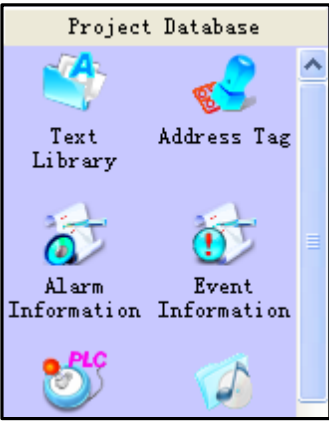
Connector	HMI	PLC/Controller
		
PLC Parts	Function Parts	Project Database
		



1. Right click on the Graphic Element Window to switch between big icon and small icon of parts:

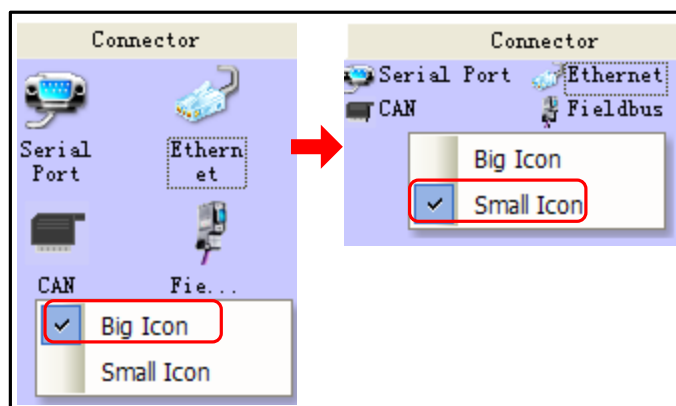

2. Hover mouse over icons of HMI or PLC to view information of the corresponding devices:



1.4.2 Project Files Window

Project files window is for displaying all graphic libraries, macro files, recipe files and other information include in the current project.

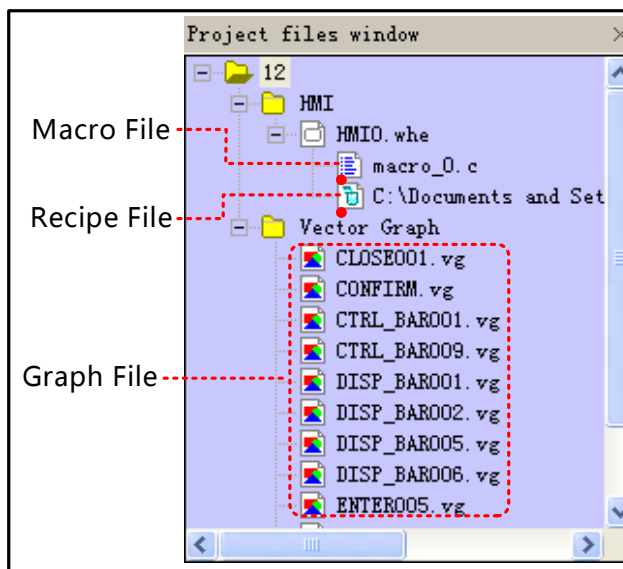

1. Double click macrocode file in Project files window to open macro edit window and edit corresponding macrocode.
2. Double click graphic files in Project files window to open graphic edit window and edit corresponding graphic.

1.4.3 Project Sstructure Window

Project structure window is for displaying all the elements in the current project by tree diagram or previews.

Tree structure: Displaying all the elements in the current project by tree diagram:

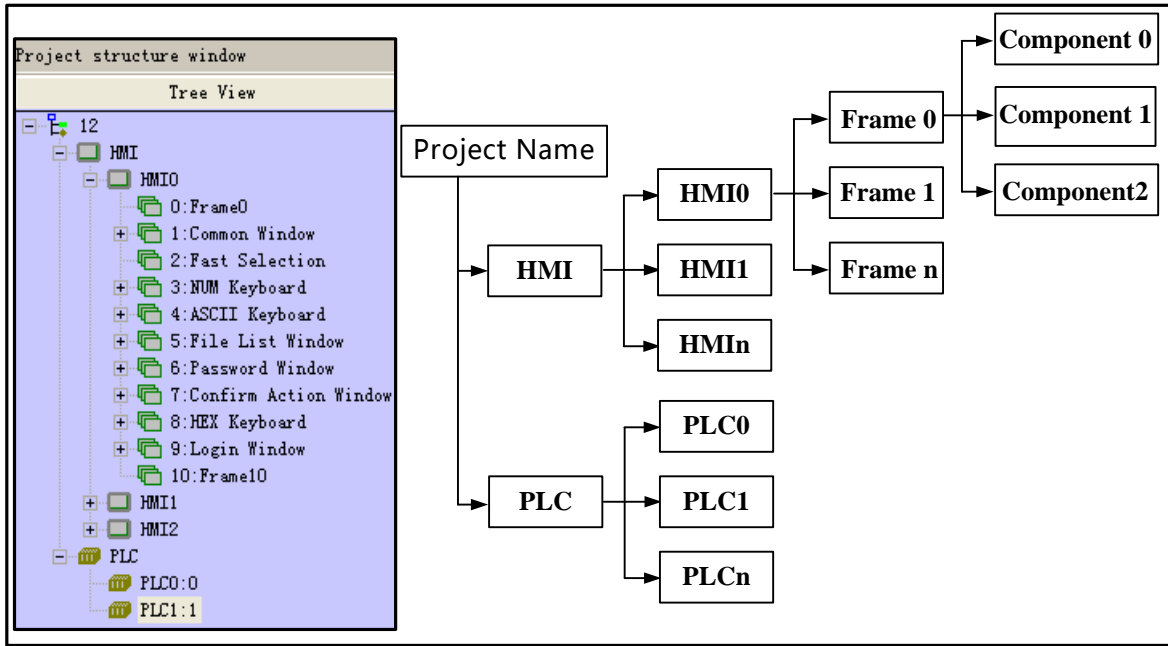

Click the project name in Project structure window to expand the topological structure; Click “HMIn” or “Frame n” to display the responding configuration window of the certain HMI; Click component to display configuration window which the component belongs to.

Preview: Display the frames of the configuration project in the form of thumbnail.

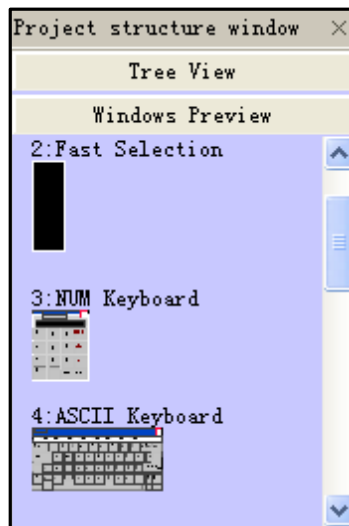

1.4.4 Message Window

Message window displays information of the loaded projects and compilation results, in order to facilitate users accurately search the errors in the project.

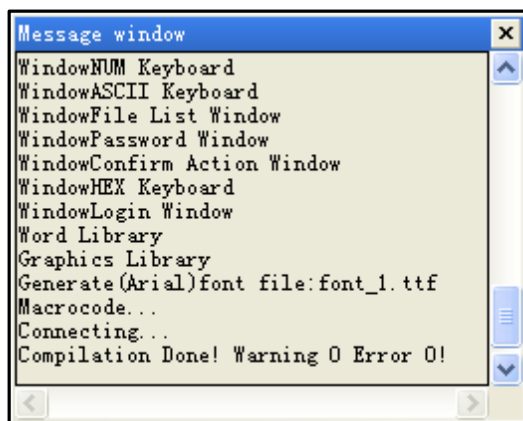

Users could delete or export compilation information in Message window by right click.

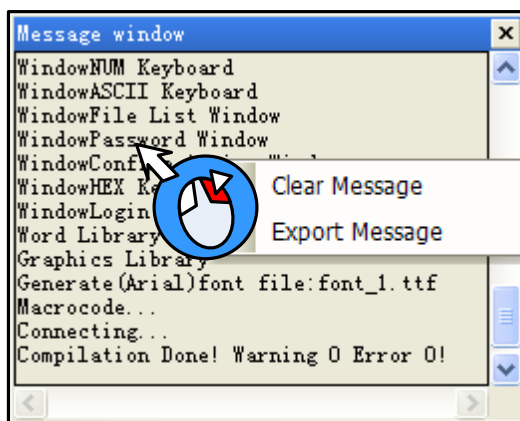

Clear message: clear all the compilation information shown in Message window.

Export message: export all the compilation information shown in Message window to the current project file, the exported file name is log.txt by default.

1.4.5 Component List Window

Component list window is for check information of all the components used by current projects, including affiliated HMI/PLC, Frame No., component ID, address type, address and so on.

HMI	Frame ID	Frame	Part	Read PLC	Read Addr (Words)	Write PLC	Write Addr (Words)
HMI0	7	Confirm ...	SWD1				LW:9370 (1)
HMI0	8	HEX Keyb...	TD5		LW:9190 (6)		
HMI0	8	HEX Keyb...	TD4		LW:9180 (6)		
HMI0	8	HEX Keyb...	TD3		LW:9070 (6)		
HMI0	9	Login Wi...	NI2		LW:9040 (2)		LW:9040 (2)
HMI0	9	Login Wi...	SB5				LB:9166 (1)
HMI0	9	Login Wi...	SBO				LB:9165 (1)
HMI0	9	Login Wi...	NI1		LW:9502 (2)		LW:9502 (2)
HMI0	9	Login Wi...	TIO		LW:9486 (10)		LW:9486 (10)



1. Open Component list window from the drop list of **View** Menu.
2. Double click the line of a component, then configuration edit window will change to the frame which the component belongs to.

1.5 Configuration Edit Area

The windows can be opened in configuration edit area areas follows:

- Construct Window

Open Construct window by clicking “Construct Window” in **【Window】** menu or clicking project name in Project structure window.

- HMI Edit Window

Drag a HMI into the Construct Window, and then open HMI Edit Window by right clicking on the HMI icon and select “Edit” , or clicking “HMI n” or “Frame n” in Project structure window.

- Graphic Edit Window

Open Graphic Edit window by creating a new graphic or by double clicking one graphic file in Project files window.

- Macro Edit Window

Open Macrocode Edit Window by creating a new macro or by double clicking macro files in Project files window.

- Edit Init Window

Enter the Edit Init Window by selecting HMI and clicking the  icon of the Database Toolbar in Construct Window, or by clicking the  in HMI Edit Window.



When multiple edit windows are opened, you can arrange the windows by “Cascade”/ “Tile Horizontally”/ “Tile Vertically” in **【Window】** menu.

1.5.1 Construct Window

Users can configure communication connection between devices and set communication parameter in Construct Window.

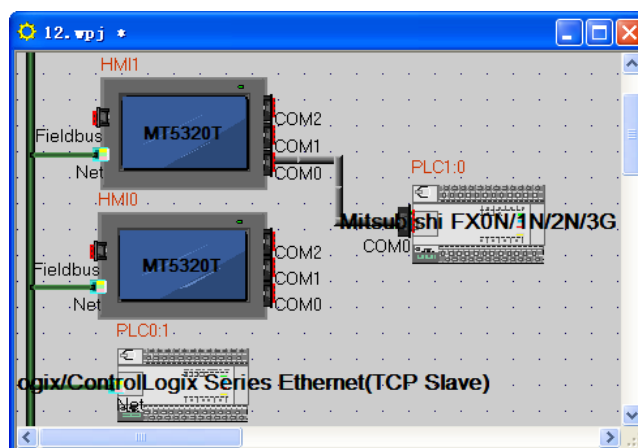

- Communication connection configuration

Drag devices and cables from **【Connector】**/ **【HMI】**/ **【PLC】** list of Graph element window into the Construct Window. Drag devices to connect with wire ends. To make sure the connection is established, drag devices, then the properly attached wire ends will move with the mouse.

- Communication parameter setting

Double click icon of HMI or PLC to open **【HMI Attribute】** or **【PLC Attribute】** .

- Serial communication

Set serial communication parameter in **【COMX Setting】 — 【HMI Attribute】**; Set communication parameters of PLC/Controller in **【PLC Attribute】** .

- Ethernet communication

Set communication parameters of HMI or PLC/controller in **【HMI Attribute】 — 【Network Device Setting】** .

- Field Bus communication

Set communication parameters of HMI or PLC/controller in **【HMI Attribute】 — 【Field Bus Setting】** .

[More details about communication please refer to 【Advanced Part 14 HMI Communication】](#)

1.5.2 HMI Edit Window

Design and edit project frames in the HMI Edit Window.

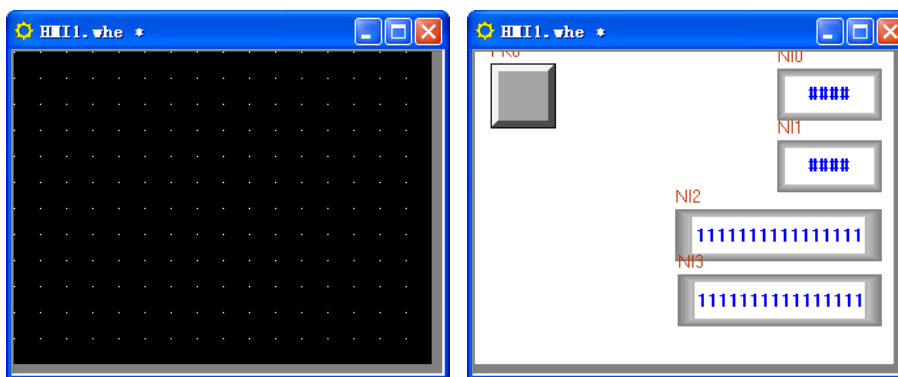

1.5.3 Graphic Edit Window

Users could edit vector graphics (.vg) and bitmap graphic (*.bg) in Graphic Edit Window.

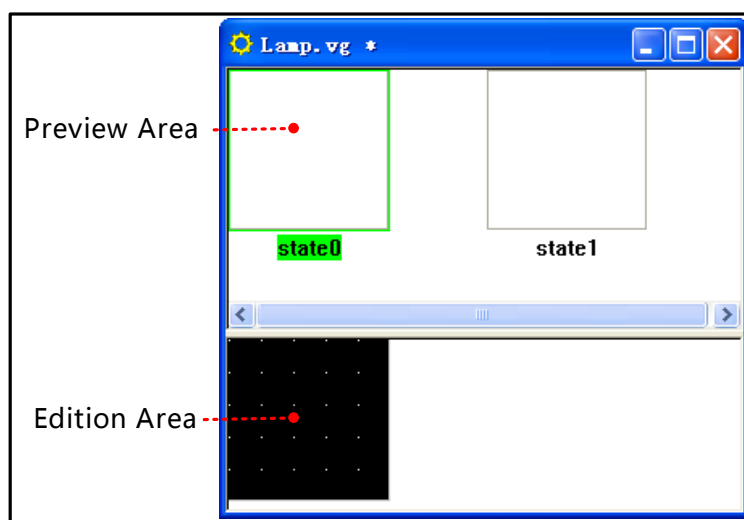

[More details about graphics edit please refer to 【Advance Part 5.3 Graphic Library】](#)

1.5.4 Macro Edit Window

In Macro Edit Window, users could write source code to realize such functions as operation and logic by using standard C language.

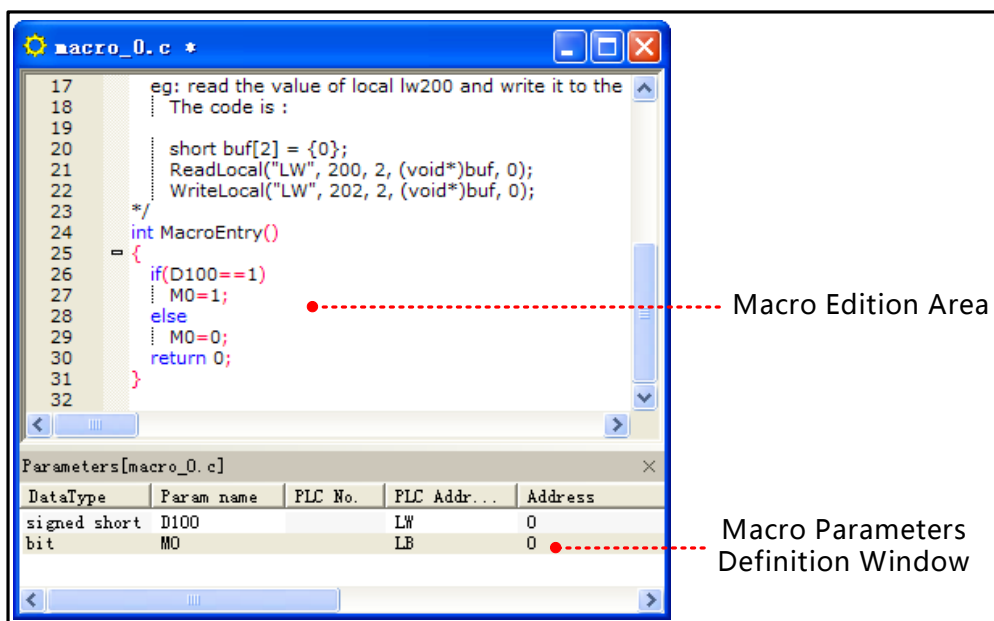

[More details about Macro please refer to 【Advance Part 9 Macro】](#)

1.5.5 Edit Initial Window

In Edit Initial Window, users could replace or edit the default initial window of HMI.



[More details about initial window please refer to 【Advanced Part 2.8 LOGO Screen \(Logo\)】](#)

2 Basic Design Method

2.1 Window screen

This chapter mainly introduces the specification of basic windows in Kinco HMIware , and how to use and display them.

2.1.1 Specification of window screen

Specification of new basic window:

Size (pixel) (width × height)	Max size (pixel) (width × height)	Min size (pixel) (width × height)	Number
320×234	320×234	10×10	1~32768
320×240	320×240		
480×234	480×234		
480×272	480×272		
640×480	640×480		
800×480	800×480		
800×600	800×600		
1024×768	1024×768		

2.1.2 Window Display Methods

Change window

Window change is to shut down the current window (including the sub window) and open another appointed one.

This operation can be finished by the following two methods :

- Use function key

Function key:[change window],fill a number in [window number]

You can change window though touch the function key.

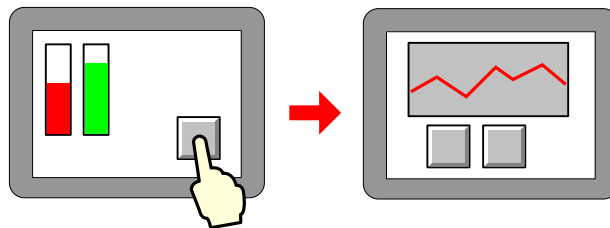

[More information refers to 【Advanced Part 4.2.6 Function Key】](#)

- Use plc control

“PLC control” :[change window],determine a control address,

You can change window by changing the value in this address.

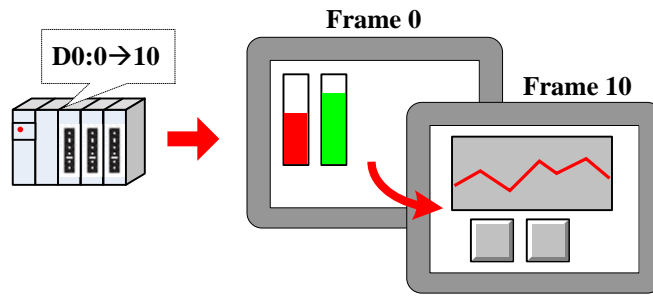

[More information refers to 【Advanced Part 4.15.5 PLC Control】](#)

- Window overlay

Window overlay is to integrate some windows into one screen.

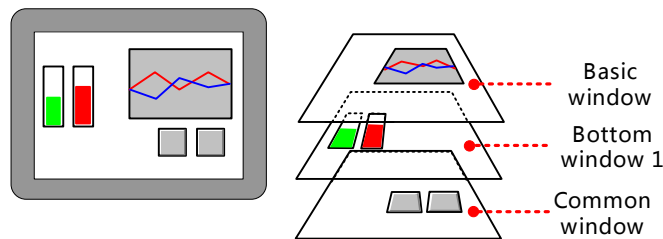

This function can be realized with two methods:

- Bottom window

Double click at the space on the basic window, you can see [window attribute] frame. Once chosen as a bottom window, all the components on it will also show on the basic window.

Default common window:[1: Common Window], users also can define any other one freely. All the components on the common window will show on all the basic windows.

[More information refers to 【Advanced Part 3 Window】](#)



1. 3 bottom windows can be used by one basic window at most
2. only one common window
3. Only components of bottom window or common window are shown on the basic window, excluding attribute settings like background color or frame color.

- Window overlay

Window overlay is to integrate some windows into one screen.

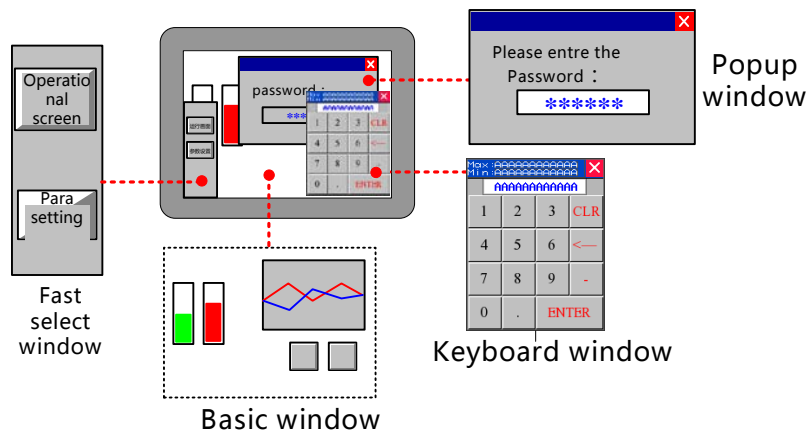

This function can be realized with following methods:

➤ Direct window

You can switch on or off to open or close popup the window. Its size is determined by the one of direct window. Keyboard window is direct window.

[More information refers to 【Advanced Part 4.8.1 Direct Window】](#)

➤ Indirect window

By changing the value, you can open or close the specific window. Its size is determined by the one of indirect window.

[More information refers to 【Advanced Part 4.8.2 Indirect Window】](#)

➤ Function key

Function key:[Popup window] to open the specific window,[close window] to close it.Its size is determined by none but itself.

[More information refers to 【Advanced Part 4.2.6 Function Key】](#)

➤ Fast selection window

Default fast selection window [2: Fast Selection], users also can define any other one freely.

By click [Menu] on task bar, the fast selection window will display and it will shut down after click again. it. Its size is determined by none but itself.

[More information refers to 【Advanced Part 3 Window】](#)



-
1. No limit of popup window .But it's better to use much fewer or much RAM will not be released.
 2. only one fast selection window
-

● Window move

The place will be changed by using “control bar” of function key.

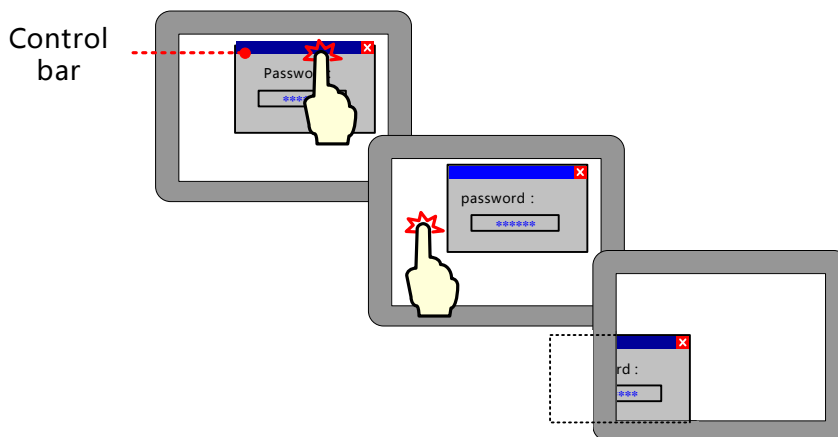

[More information refers to 【Advanced Part 4.2.6 Function Key】](#)



Basic window cannot be moved ,only popup windows can.

2.1.3 Display Position

Different types of windows display in different styles:

Popup window by “direct window” or “indirect window”

- According to component position

The popup window will display where the “direct window” or “indirect window” is put.

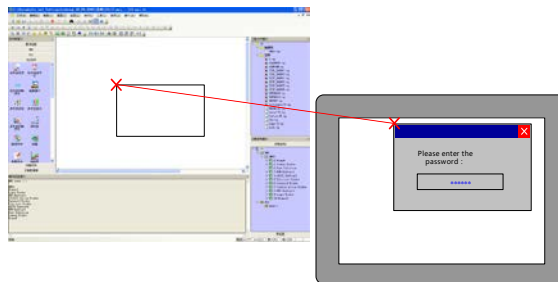

- According to setting value

Set [variable display coordinate], values or addresses determine the position of popup window (coordinate of top left corner point).

- Function key [popup window]

Set values of “X” ,” Y” in [window attribute]-[position], they are the coordinates of the popup window.

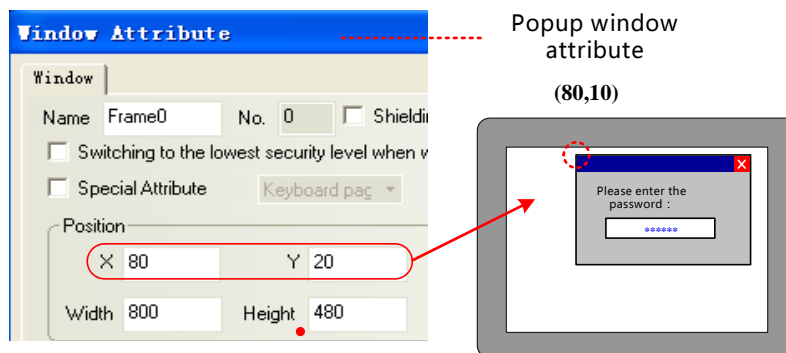

Its position cannot be changed when the screen is a basic window and it can only display full screen.

2.1.4 Display Order

Different types of windows display on a screen in its order.

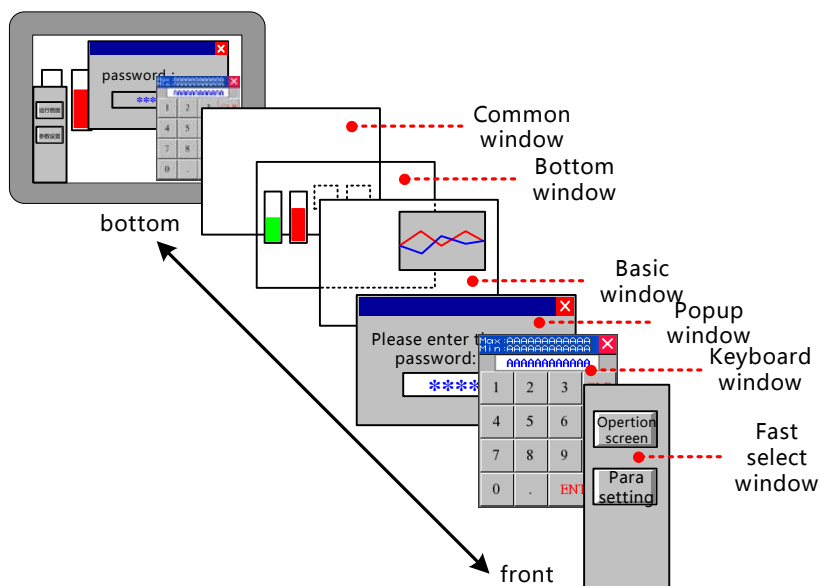

2.1.5 Copy/Delete Windows

(1) copy window

Copy in Same project or different projects

- Same project

Same project: same HMI or different HMIs

➤ Same HMI

Copy things from frame A to frame B:

- Right click [copy]

Right click the component on frame A , choose[copy],then change to frame B and paste it on it. By this way, only component is copied, not window attribute.

- [copy/delete window]

Click[frame]-[copy/delete window] , set “count” , “source window” , “destination windows” , click “OK” . By this way, all the components and window attribution are copied.

➤ Copy across HMI

Copy across HMI can only realized by right click [copy].



[Screen]—[copy/delete window]: this copy operation across the HMI windows are not supported

- Copy across project

When copy across different projects, you should open the related two projects with Kinco HMIware, and then right click [copy].

(2) delete window

You can delete windows as follows:

- Right click [delete]

Right click the frame you want to delete under [project structure window], then it will be delete.



Windows are deleted one by one, multi-deletion is not supported.

- [copy/delete windows]

Click HMI you want to handle, click [screen]-[copy/delete windows-[delete window],[delete single window]can delete an appointed window,[delete multi-windows]can delete continuous-number windows.

[More information refers to 【Advanced Part 3.3 Edit Window】](#)

2.2 Draw

This chapter introduces Kinco HMIware image format and picture drawing and using.

2.2.1 Image Format

Kinco HMIware mainly supports two format vg and bg. When creating a vector graph, its default format is vg, while creating a bit map, its default format is bg.

Differences between vector graph and bitmap is shown as below:

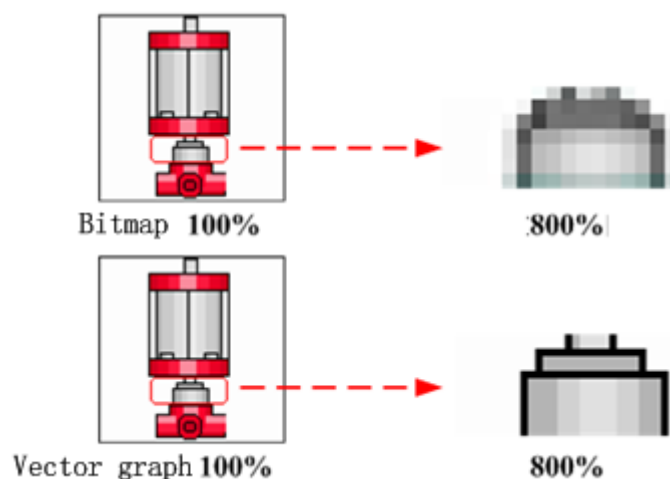

Specification of created graph:

Graph format	Max size(pixel) (width × height)	Min size(pixel) (width × height)	Graph types	State limit
Vector graph (vg)	320×240	2×2	line, round-corner rectangle, rectangle, ellipse, sector, broken line, curve, polygon and so on	1~256
Bitmap (bg)			Jpg, bmp, gif, png and so on	

2.2.2 Vector

[vector],in short, enlarge or narrow without distortion. Geometric figures which can be infinitely enlarged without color change and blurred are mostly in this form

In Kinco HMIware, you can create vector graph through in two ways:

- Import from image library

Import graph you need from [image library]-[vector graph].

[More information refer s to \[Advanced Part 5.3.1 Import Grahpics\]](#)

- Use drawing tools in
 - Draw in picture edit window

Use component [vector graph].open window edition, draw as you need with drawing tools, save, exit edit window, a new vector graph is finished.

[More information refers to \[Advanced Part 5.3.2 Build New Graphics\]](#)

- Draw in configuration window

Draw in the edit window with drawing tools, right click the graph done, choose “save to the VG map” , a new vector graph is finished

[More information refers to \[Advanced Part 5.3.2 Build New Graphics\]](#)

Now we will introduce how to use drawing tools:



Choose an icon, drag in the edit area :

line

Graphic instrument	Drawing step
	<p>①~② move mouse into edit area,” +” shows up, press left on mouse and drag</p> <p>③ release at the position you prefer a line is finished</p>

curve

Graphic instrument	Drawing step
	<p>① move mouse into edit area,” +” shows up, press left on mouse and drag</p> <p>② ,press left on mouse and drag</p> <p>③ release the mouse you can see a circle</p> <p>④ click at the start point</p> <p>⑤ click at the finishing point ,a curve is finished</p>

rectangle 

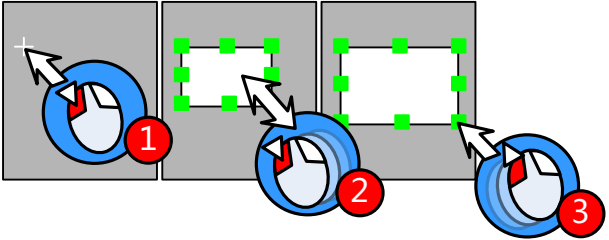
Graphic instrument	Drawing step
	<ol style="list-style-type: none"> ➊ move mouse into edit area," +” shows up ➋ press left on mouse and drag ➌ release at the position you prefer a rectangle is finished

roundrectangle 

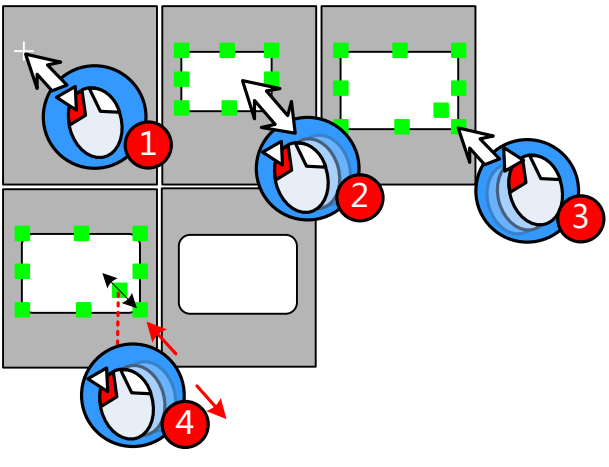
Graphic instrument	Drawing step
	<ol style="list-style-type: none"> ➊ move mouse into edit area," +” shows up, click to set the starting point ➋ press left on mouse and drag to the position you want ➌ release the mouse, a roundrectangle is finished ➍ Point at the small green block on the bottom right corner, when the arrow turns two-ways, press left on mouse and drag, ou can change its radius.

polyline 

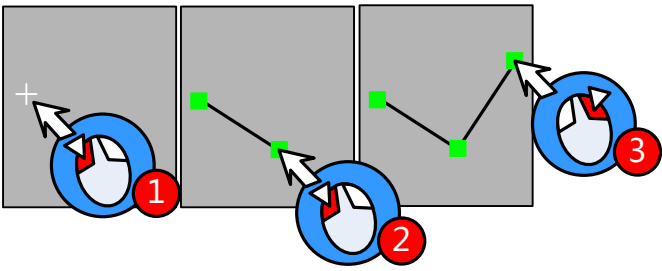
Graphic instrument	Drawing step
	<ol style="list-style-type: none"> ➊ move mouse into edit area," +” shows up, click to set the starting point ➋ click at the set points ➌ right click to finish drawing

polygon 

Graphic instrument	Drawing step
--------------------	--------------

	<p>①~⑦ move mouse into edit area," + " shows up, click 7 times at 7 points</p> <p>⑧ right click to finish drawing</p>
--	---

ellipse

Graphic instrument	Drawing step
	<p>① move mouse into edit area," + " shows up, click to set the starting point</p> <p>② press left on mouse and drag to the position you want</p> <p>③ release the mouse, a ellipse is finished</p> <p>With the same width and height ,a ellipse turns to be a circle</p>

sector

Graphic instrument	Drawing step
	<p>① move mouse into edit area," + " shows up, click to set the centre point</p> <p>② press left on mouse and drag to the position you want</p> <p>③ release the mouse ,a closed circle shows up</p> <p>④ click at starting point</p> <p>⑤ click at the ending point ,a sector is finished</p>

2.2.3 Geometric Figures Attribution

Attributions as below :

graphics	Graphic samples	Setting attribute
----------	-----------------	-------------------

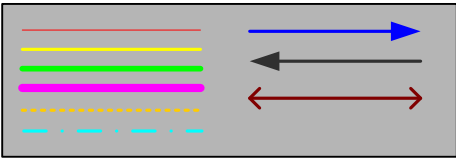
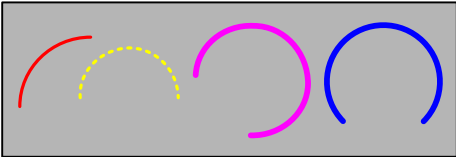
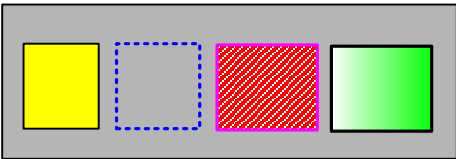
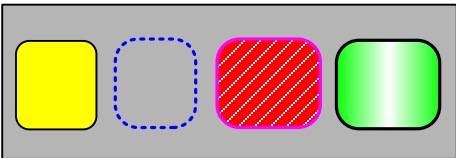
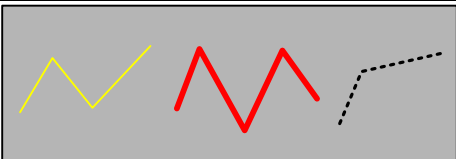
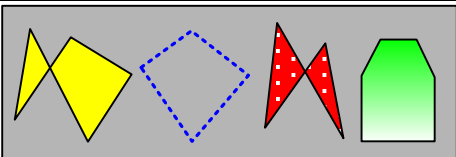
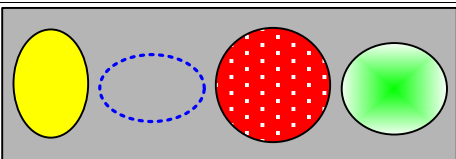
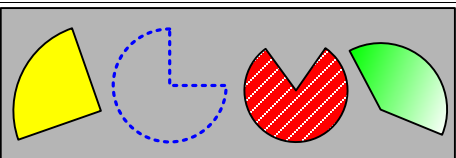
Line		line color, line style, line width, arrow style
Curve		line color, line style, line width
Rectangle		line color, background fill color, foreground fill color, pattern fill, fountain fill, line style, line width
RoundRectangle		line color, background fill color, foreground fill color, pattern fill, fountain fill, line style, line width
PolyLine		line color, line style, line width
PolyGon		line color, background fill color, foreground fill color, pattern fill, fountain fill, line style, line width
Ellipse		line color, background fill color, foreground fill color, pattern fill, fountain fill, line style, line width
Sector		line color, background fill color, foreground fill color, pattern fill, fountain fill, line style, line width

Users can modify attribute in two ways:

- Attribution frame

Double click the graph, modify in [graphics attribute]

- Tools bar













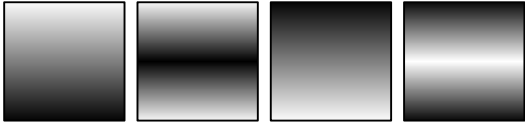



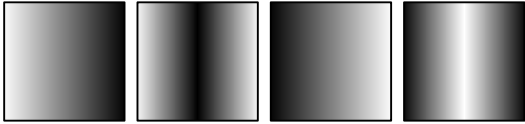



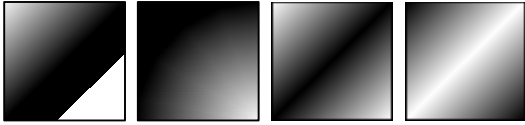

Choose the graph, modify its attribute through[drawing tools]/[line width]/[line style].In this way, you can only set line color\filled color\line width and line style.

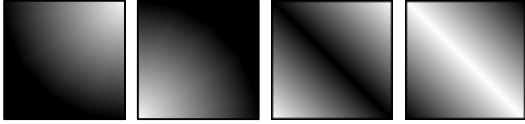
2.2.4 About Fountain Fill

The closed graphics can be set fountain fill.

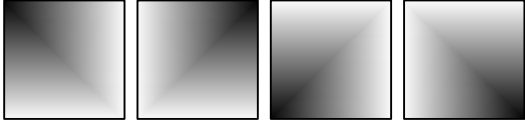
Double click the graph, choose[fountain fill]choose the foreground fill color, background fill color line color .

Example:

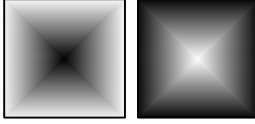
Fountain Fill	Foreground Fill Color	Background Fill Color	Line Color	Deformation
Horizontal				
Vertical				
Oblique				
Under Oblique				
Corner of Radiation				
Centre for Radiation				

2.2.5 Bitmap

[bitmap], in short, structured with pixel, enlarger or narrow with distortion. Bitmap is structured with pixel array and each has its own information. We can change the graph by dealing with every pixel.

In Kinco HMIware, bitmap is created in two ways:

- Import from image library

Import from[image library]-[BG]

[More information refer s to \[Advanced Part 5.3.1 Import Grahpics\]](#)

- Import pictures in forms of jpg、 bmp、 gif、 png

Bitmap, open the edit window ,import pictures in forms of jpg, bmp, gif, png and so on, save, exit ,a new bitmap is created.

[More information refers to \[Advanced Part 5.3.2 Build New Graphics\]](#)

2.2.6 About Transparent Color

If a picture influences the aesthetic, users can deal with the pure color with[transparent] tool in drawing tools :

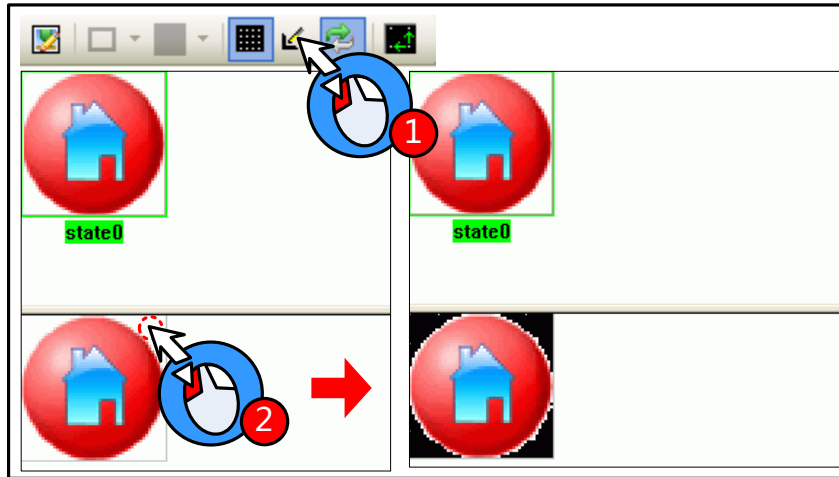

“Transparent” can only deal with simple actions, not suggested to use.

Besides, bitmap supports PNG format, so you can edit a picture with another editor and convert it into PNG form before import.



GIF and PNG form picture doesn't support transparent action

2.3 Text

User can add the text for the component by the following way in Kinco HMIware.

- Set in Draw Toolbar.



- Click the [A] icon in Draw Toolbar, and input the needed text content in [Text Attribute]-[Display Setting].

Position free

- Set [Use Tag] or [Use TextLib] in the component attribute.

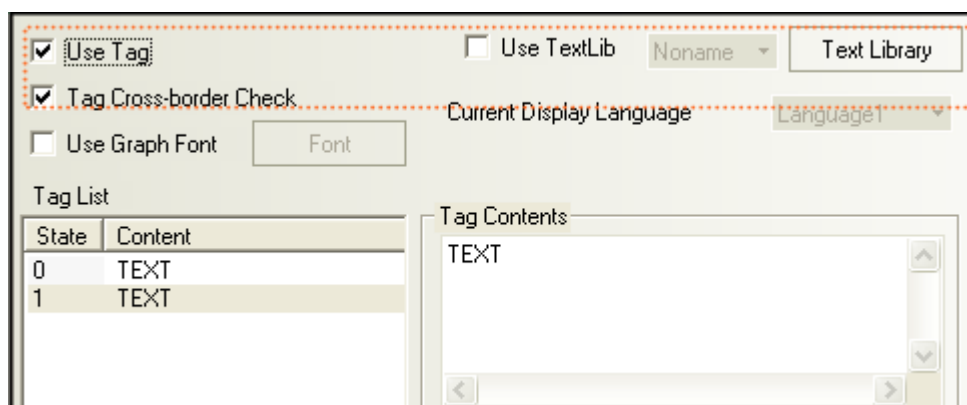

Select [Use Tag] in the [Tag] option in component attribute, and input the needed text contents in [Tag Contents], or select [Use TextLib], if there are TextLib logon in the project.

Only shown on the component

2.3.1 Font Type

Kinco HMIware provides 3 available fonts, i.e. dot matrix font, vector font and graph font. The advantages and disadvantages of these three fonts will be described as follows; users can select the suitable font type according to its characteristics.

2.3.2 Dot Matrix Font

Dot Matrix font saves the bitmap for each character of the required Chinese character set. Each primitive (small picture) is spliced together to form a character string when it is used.

- Disadvantages of dot matrix font:

- Only SimSun is supported.
- The scaling effect is poor.

For each character, 3 kinds of bitmaps (8×8, 16×8, 24×16 (height*width)) are reserved respectively, so the effect is very poor when the larger font is displayed, as shown below:

Word size	16	24	32	48	64	72
Exam	123	123	123	123	123	123

- full-width deal only for unASCII characters

Kinco HMIware deals with ASCII characters as half-width ones, while unASCII as full-width ones. So if each character has different width, the intervals may be different:

Г е о ь ё д н с н ч щ п

- advantages of dot matrix font:

A smallest storage space is occupied by dot matrix font.

2.3.3 Vector Font

Vector font intercepts the characters that are used by the user from the corresponding font library through checking the setup of the user-set fonts, and then makes them into TrueType font file (*.ttf format) for HMI to use.

- Disadvantages of vector font:

- Only Support the TrueType installed in the operating system (*.ttf format).
- Without selecting “Vector Fonts Edge Blur” , the font is displayed with some projections, and comparison results as shown below:

configuration

choose vector fonts edge blur

configuration

not choose vector fonts edge blur



“Vector Fonts Edge Blur” can be set in [HMI Attribute]-[HMI Extended Attributes].

- Advantages of vector font:
 - A smaller storage space is occupied. It adopts the method of intercepting the matrix from the font file, thus reducing the size of the font file. For the same character in the same font, only one matrix needs to be intercepted regardless of the size, color, bold/italic styles.
 - The font size can be set freely without any deformation
 - Support the alignment method for multiple-line text.
 - Text library can support the vector font.
- System default vector font setting

User can define the default vector font in [System Default Vector Font] in [Option].

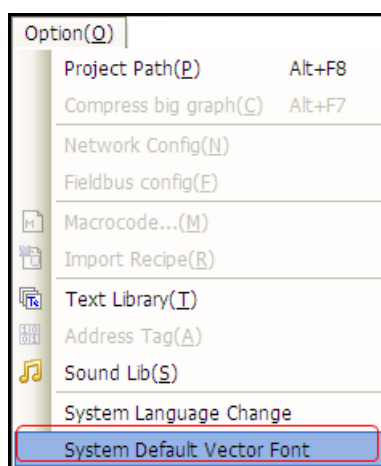

[Example] Set System Default Font as “Arial” , when using tag or text and select “Vector Font” , it will select “Arial” by default automatically.

2.3.4 Graph Font

Graph font treats the whole character string as a whole, and intercepts the whole bitmap and saves it in the project.

➤ Disadvantages of graph font:

- A larger storage space is occupied. Because the character string saves as bitmap, so it needs a larger space. For example: Four characters “configuration” displayed in zero SimSun needs 1824 bytes, as shown below:

configuration

In addition, the graph font should be intercepted again if the content, size or colors vary slightly, thus causing a linear increase in the occupied space.

- Text library can't support the graph font.
- Advantages of graph font:
 - Support all installed fonts in current operating system.
 - The scaling effect is good.

2.3.5 Text Attribute Edition

User can modify the font attribute through the following two methods:

- Modify in the component attribute dialog box

Double-click component /text to set the font attributes in [Component Attribute]-[Tag] or [Text Attribute].

- Modify in Font Toolbar

Selected component/ text, and then set the font attributes in [Font Toolbar]. This method can support multi-modify font attribute.

Different font types support different font attribute to be modified, specific as below:

○: Support; --: Unsupport

Font Attribute	Graphic	Dot Matrix Font	Vector Font	Graph Font
Common	A	○	○	○
Bold	A	--	○	○
Italic	<i>A</i>	--	○	○
Underline	<u>A</u>	--	--	○
strikeout	A	--	--	○
Size	<small>A</small> <big>A</big> <x-large>A</x-large>	○	○	○
Color	A A A	○	○	○

2.3.6 Notes for Using Vector Font

Based on the special treating method for the vector font, the following conditions should be paid attention to when the vector font is used:

1. Some fonts may not support some characters, or have poor support effects.

For example, the Chinese characters can be displayed by using Arial font, because there are no corresponding Chinese characters in Arial font library. Otherwise the effect will as shown below:



2. Because the dot matrix font and graph font have many disadvantages in the storage space and scaling etc, therefore, use the vector font as much as possible when it can meet the project requirements.

3. Avoid using too many fonts as much as possible.

If too many types of vector fonts (e.g. dozens or more) are used by the user, the number of font files will be too many, thus affecting the compilation speed, downloading speed and screen switching speed.

4. Use the common fonts in operating system as much as possible.

If a certain project uses “Microsoft Elegant Black” font when it is edited on PC, and when it is transferred to another PC where no “Microsoft Elegant Black” font exists for editing, then all the “Microsoft Elegant Black” characters used in the project will be changed to “SimSun” automatically.

2.4 Keyboard

This chapter describes keyboard type and methods of calling keyboard in Kinco HMIware.

2.4.1 Keyboard Type

Kinco HMIware support three keyboard for users: NUMERAL Keyboard、ASCII Keyboard and HEX Keyboard. And users can make own keyboard or use external USB keyboard.

- NUM Keyboard: NUM Keyboard for number input component.

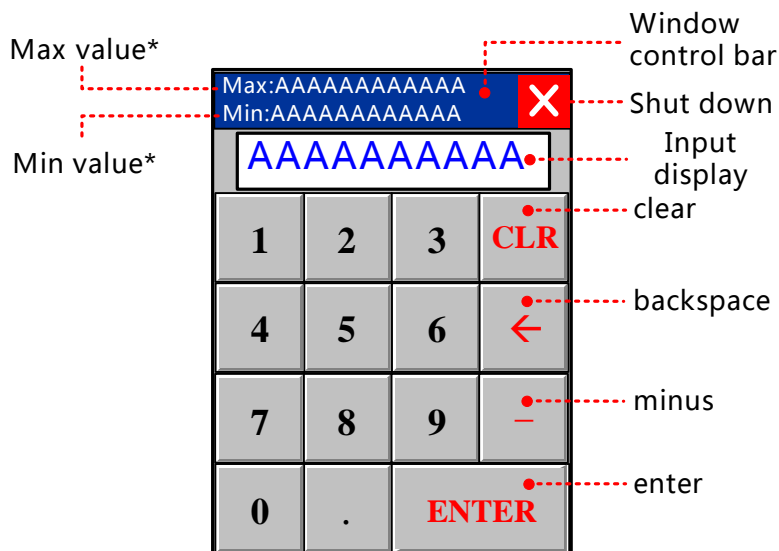

※ 1. The values shown here are max and min in Max/Min Value Setting in [Number Input Component Attribute]-[Numeric Data], Keyboard permission input value range is limited by the value.

2. If [Proportion Conversion] is selected, the values shown here are max and min after proportion conversion.

- ASCII Keyboard: ASCII Keyboard for text input component or number input component.

Lowercase:

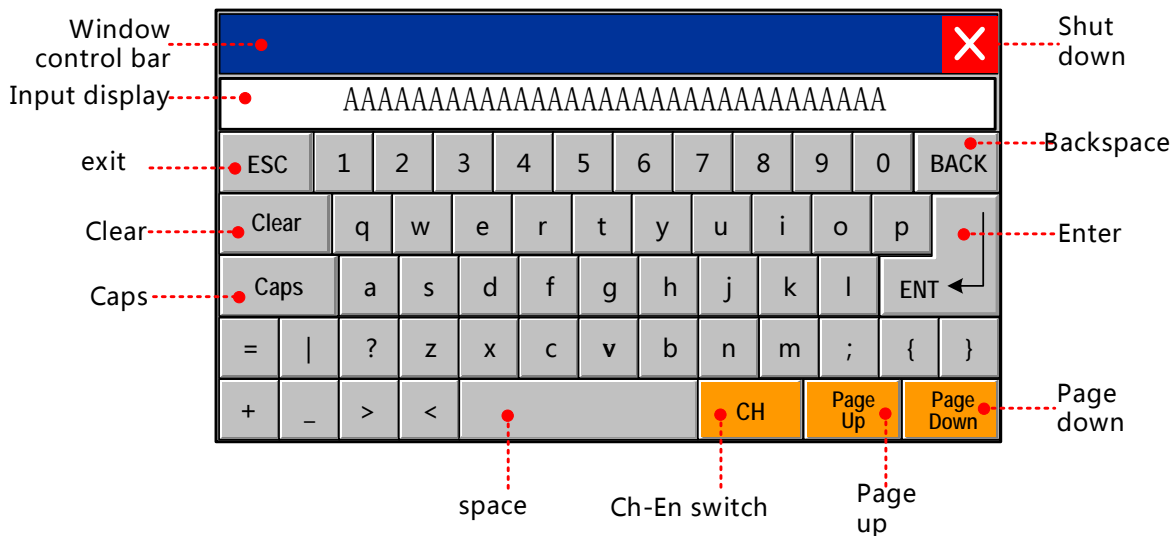

Caps:

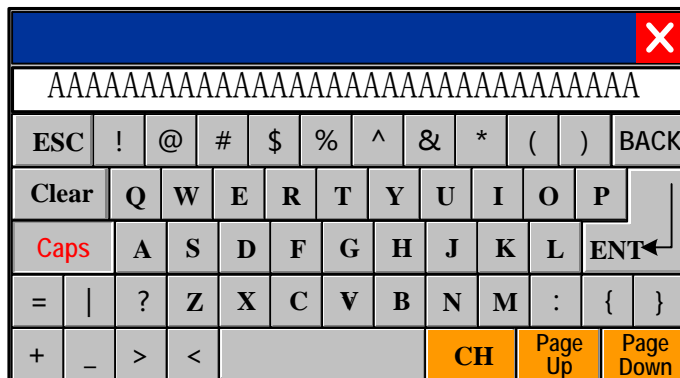

Chinese Input:

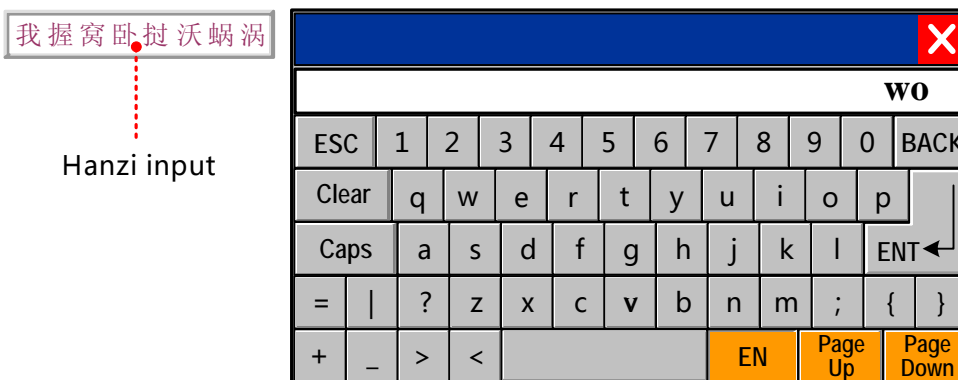

※Set Chinese Font Box Height in [HMI Attribute]-[HMI Extended Attributes], height range from 24 to 99 (pixel).

- HEX Keyboard: for HEX character input

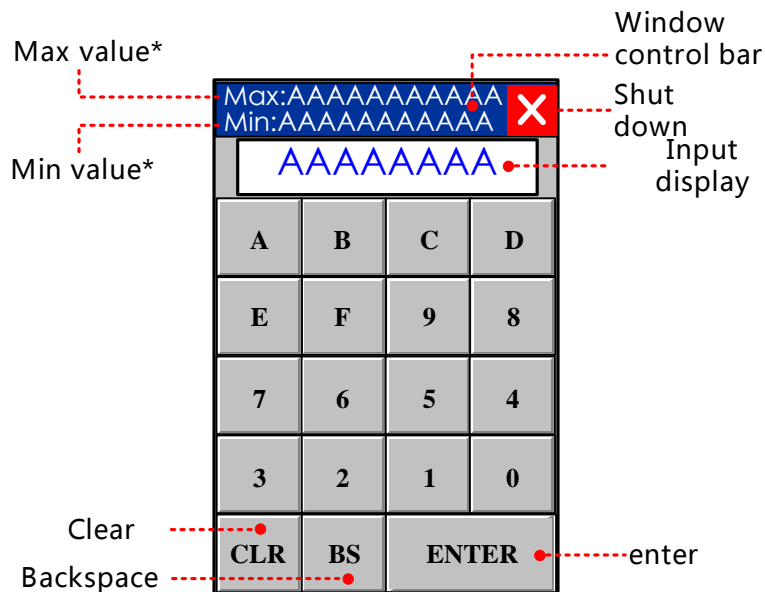

- ※ 1. The values shown here are max and min in Max/Min Value Setting in [Number Input Component Attribute]-[Numeric Data], Keyboard permission input value range is limited by the value.
- 2. If [Proportion Conversion] is selected, the values shown here are max and min after proportion conversion.

[More information refers to \[Advanced Part 4.2.6 Function Key\]](#)

2.4.2 NUM Keyboard

Through the following three methods, Number Input Component will pop up NUM Keyboard in Kinco HMIware.

- Use public windows keyboard

This method is system default.

Open [Number Input Component Attribute] - [Keyboard Setting] dialog box, and then select [Public Windows Keyboard], as shown below:

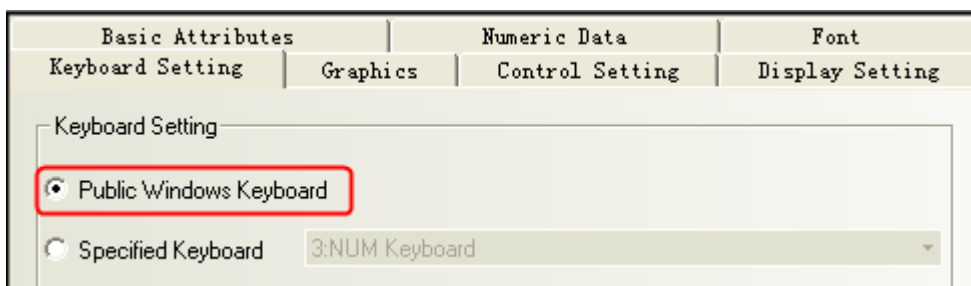

Put two “direct window” components respectively on the left and right side of [Frame 1: Common Window],choose [Frame 3: NUM Keyboard] in frame ID.

Take apart in the middle of a screen, when the components on the left side is triggered, the direct window on the right side will pop the keyboard, It’s the same with the other side.

- Use Specified Keyboard

This method can pop up keyboard made by user self.

Use specified keyboard. Only after setting window attribute as “keyboard page” can you find the page in [input attribute]-[keyboard setting]-[specified keyboard].

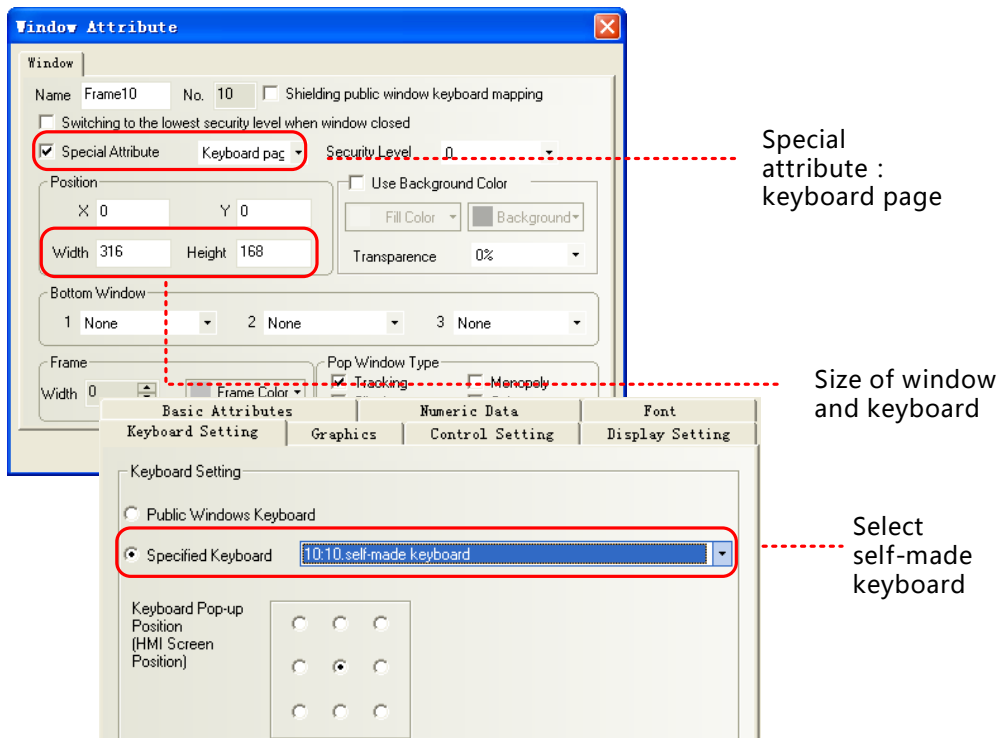

- Use external keyboard

This method need connect USB Host keyboard.

Open [Number Input Component Attribute] - [Keyboard Setting] dialog box, and then select [Not Use Pop-up Keyboard], as shown below:

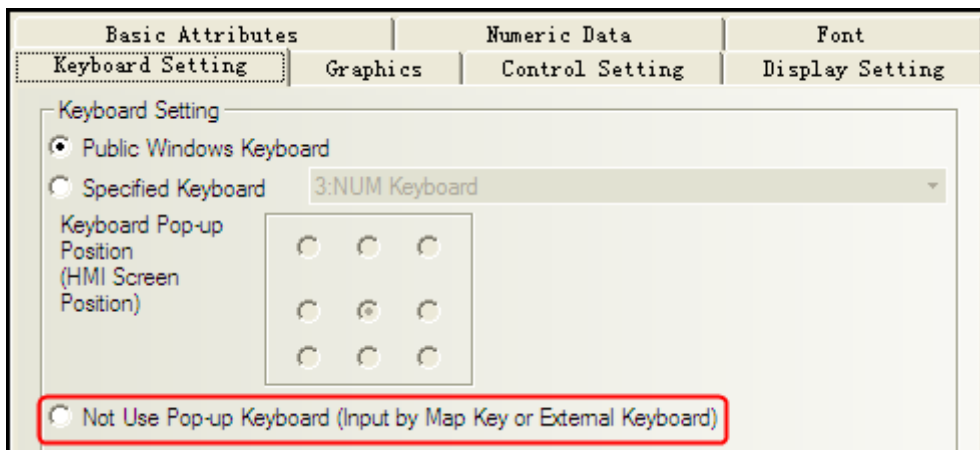

No keyboard will pop up, while user can input things through circumscribed keyboard.



It is only applicable to the HMI supporting the USB HOST.

2.4.3 ASCII Keyboard

Through the following two methods, Text Input component / Note Book component will pop up ASCII Keyboard in Kinco HMIware.

- Use Specified Keyboard

This method is system default.

Default keyboard:[Frame 4: ASCII Keyboard]

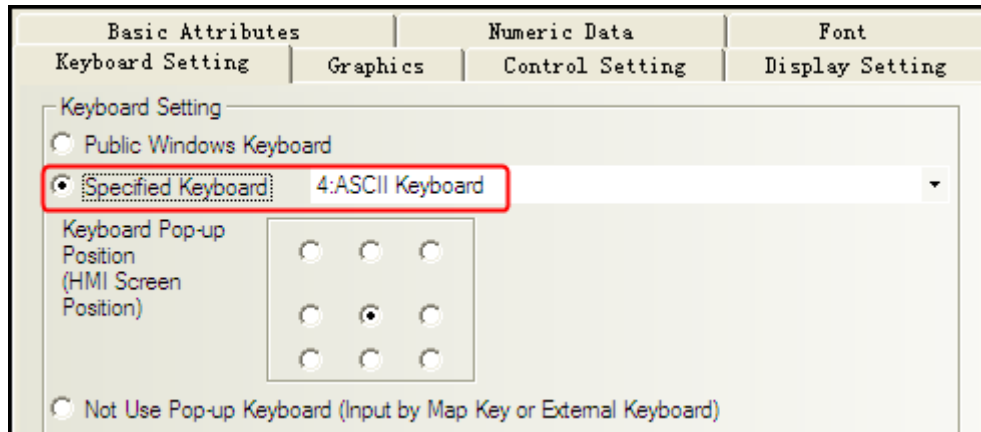

If you want to use your own keyboard, you should set it as a keyboard page, and choose the frame ID of the keyboard window.

- Use external keyboard

Same as number input, No keyboard will pop up, while user can input things through circumscribed keyboard.

2.4.4 HEX Keyboard

When input hex number, you should make it with two methods as below:

- Use Specified Keyboard

[number input attribute]-[keyboard setting]-[specified keyboard],choose[Frame 8: HEX Keyboard].

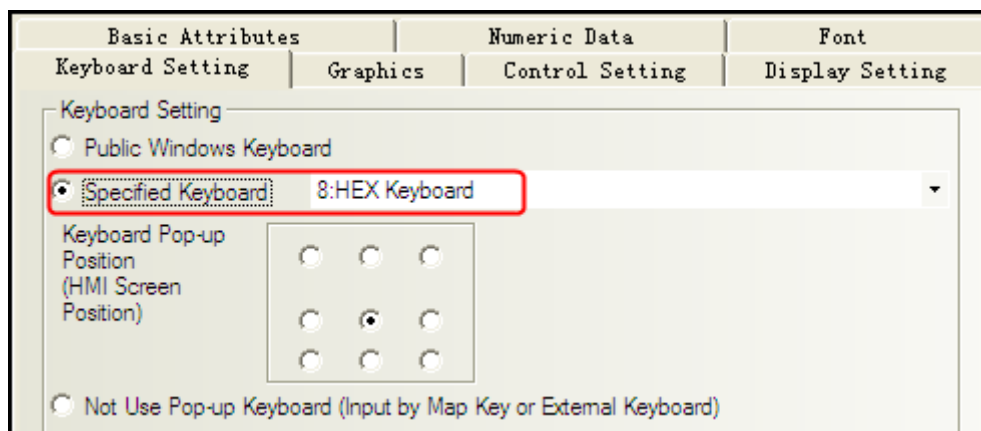

If you want to use your own keyboard, you should set it as a keyboard page, and choose the frame ID of the keyboard window.

- Use external keyboard

Same as number input

No keyboard will pop up, while user can input things through circumscribed keyboard.

2.4.5 Create your Own Number Keyboard

Num keys 0-9, enter, delete and backspace

Determine the layout:

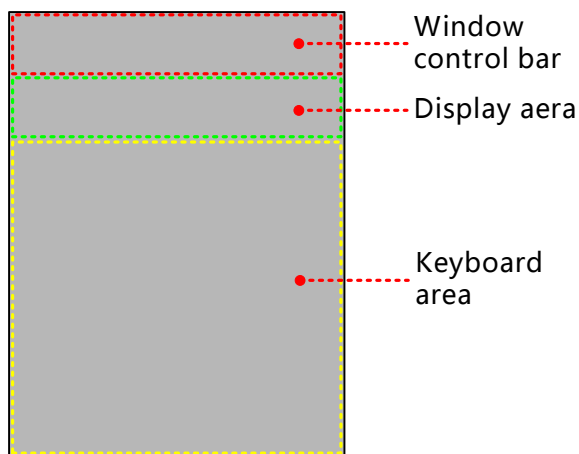

Create keyboard :

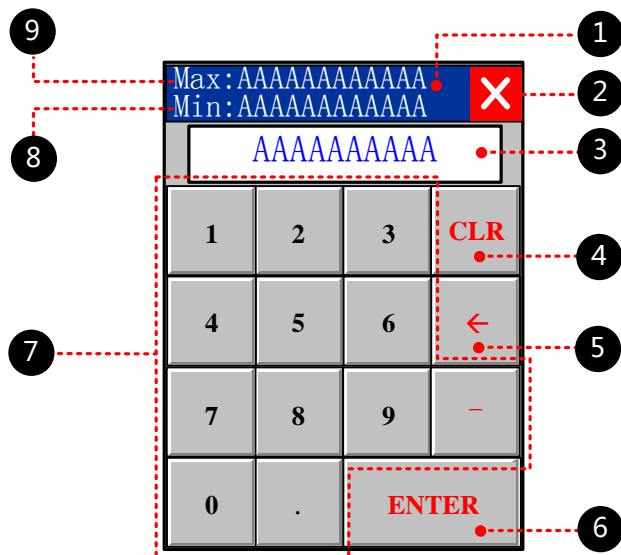



1 function key, move the window, attribute setting:

Function	Switch Window: Popup window title bar
Graphics	<div style="display: flex; justify-content: space-around; align-items: center;"> <div style="text-align: center;">State 0 </div> <div style="text-align: center;">State 1 </div> </div> <p>Select Vector Graphics:</p>

2 function key, close the window, attribute setting:



Function	Keyboard Function: Escape
----------	---------------------------

Graphics	State 0 State 1  
	Select Vector Graphics:



③ text display, display the characters, attribute setting:

Read address	LW 9070* ¹ (special register)
Data width	6



④ function key, delete, attribute setting:

Function	Keyboard Function: Clear
Tag	0: CLR; 1: CLR
Graphics	State 0 State 1  
	Select Vector Graphics:



⑤ function key, backspace, attribute setting:

Function	Keyboard Function: Back Space
Tag	0: →; 1: →
Graphics	State 0 State 1  
	Select Vector Graphics:

⑥ function key, enter, attribute setting:

Function	Keyboard Function: Enter
Tag	Sselect; 0: ENTER; 1: ENTER
Graphics	State 0 State 1  
	Select Vector Graphics:

⑦ function key, character input, attribute setting: take  for example

Function	Keyboard Function: Unicode
Tag	0: 1; 1: 1
Graphics	State 0 State 1  
	Select Vector Graphics:

⑧ number display, display min value, attribute setting:

Read address	LW 9190* ² (special register)
Data width	6

⑨ number display, display max value, attribute setting:

Read address	LW 9180* ³ (special register)
Data width	6

※ 1.LW9060 ~ LW9075 special registers, cache the latest input

- 2. LW9190 ~ LW9197 special register, min value display
- 3. LW9180 ~ LW9187 special register, max value display

2.4.6 Create your Own Unicode Keyboard

Unicode uses two bytes to form a character, often used to display characters cannot display by ASCII, kanji for example.

Take Russia as an example:

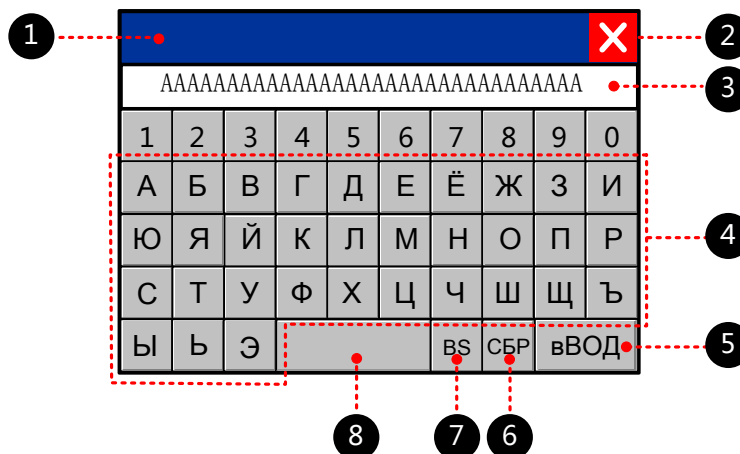

1 function key, move the window, attribute setting:

Function	Switch Window: Popup window title bar
Graphics	<div style="display: flex; justify-content: space-around;"> <div style="text-align: center;">State 0 </div> <div style="text-align: center;">State 1 </div> </div> Select Vector Graphics:

2 function key, close the window, attribute setting:

Function	Keyboard Function: Escape
Graphics	<div style="display: flex; justify-content: space-around;"> <div style="text-align: center;">State 0 </div> <div style="text-align: center;">State 1 </div> </div> Select Vector Graphics:

3 text display, display the characters, attribute setting:

Read address	LW 9060 (special register)
Data width	16
Unicode	choose

4 function key, character input, attribute setting: take И for example

Function	Keyboard Function: Unicode
Tag	0: И; 1: И
Font	vector: Arial Unicode MS
Graphics	<div style="display: flex; justify-content: space-around;"> <div style="text-align: center;">State 0 </div> <div style="text-align: center;">State 1 </div> </div> Select Vector Graphics:

5 function key, enter, attribute setting:

Function	Keyboard Function: Enter
----------	--------------------------

Tag	0: вВОД; 1: вВОД
Font	vector: Arial Unicode MS
Graphics	<div style="text-align: center;"> State 0 State 1  </div> Select Vector Graphics:

6 function key, delete, attribute setting:

Function	Keyboard Function: Clear
Tag	0: СБР; 1: СБР
Font	vector: Arial Unicode MS
Graphics	<div style="text-align: center;"> State 0 State 1  </div> Select Vector Graphics:

7 function key, backspace, attribute setting::

Function	Keyboard Function: Back Space
Tag	0: BS; 1: BS
Font	vector: Arial Unicode MS
Graphics	<div style="text-align: center;"> State 0 State 1  </div> Select Vector Graphics:

8 function key, space, attribute setting:

Function	Keyboard Function: Unicode
Graphics	<div style="text-align: center;"> State 0 State 1  </div> Select Vector Graphics:

2.4.7 Call Keyboard in the Group Component Library

Kinco HMIware provides 21 default keyboards in Group Components Library, the method of calling the keyboard in Group Components Library is as follows:

【example】 number input calls a keyboard made of group (text input/note book)。 [Example]

- 1 Create a new window named Frame10, and select [Keyboard Page] from [Special Attribute] in Window Attribute.

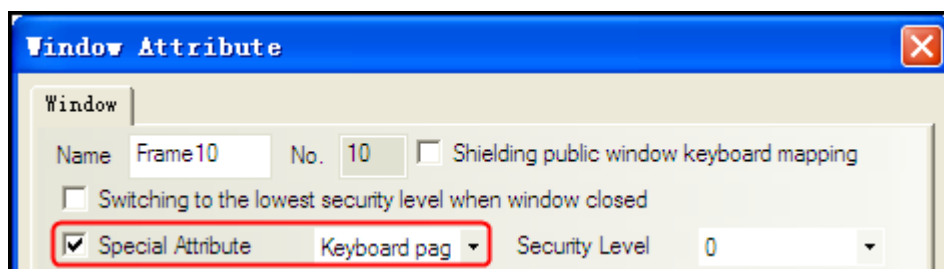

- 2 Right-click the mouse in the blank area in the Frame10 window to select [Group]-[Use the group element], then select [keyboard] from [Group Components] in [Edit Box of Group Components Library], and select the right keyboard from [Preview] and click [Place Group Components] button, then the keyboard will appear in Frame10.

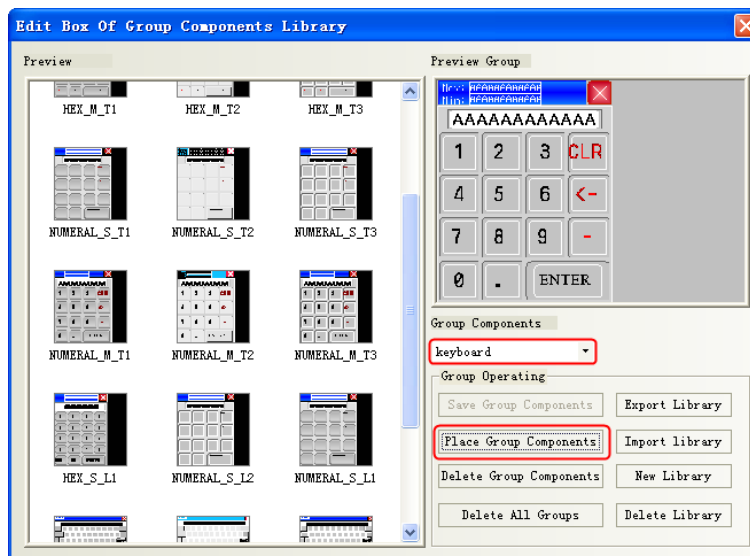

- ③ Modify the window size of Frame 10 to the same size as the specified keyboard.
- ④ Place one number input component (LW0) in Frame0, and select [Specified Keyboard] in [Keyboard Setting] in [Number Input Component Attribute], select [10:Frame10].

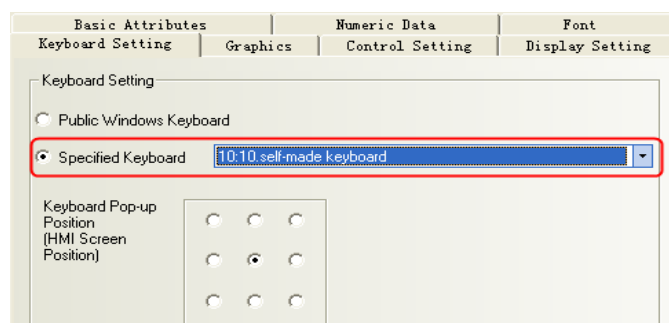

- ⑤ Save, compile, and run the project. Then click the number input component (LW0) to make the specified num keyboard pop up in the middle of HMI screen.

2.5 Code Type

Kinco HMIware can support code type: BIN, BCD and LSB. User can select the correct encoding type according to the actual encoding type of data process.

2.5.1 BIN

BIN (Binary) is binary code type. Most digital systems are based on BIN code to process the data

Code Type	Word data range	Dword data range
Signed BIN	-32767~32767	-2147483648~2147483647
Unsigned BIN	0~65535	0~4294967295

[Example]

15	14	13	12	11	10	9	8	7	6	5	4	3	2	1	0
2 ¹⁵	2 ¹⁴	2 ¹³	2 ¹²	2 ¹¹	2 ¹⁰	2 ⁹	2 ⁸	2 ⁷	2 ⁶	2 ⁵	2 ⁴	2 ³	2 ²	2 ¹	2 ⁰

Convert binary data 1001 0100 to decimal data:

$$1001\ 0100 = 1 \times 2^7 + 0 \times 2^6 + 0 \times 2^5 + 1 \times 2^4 + 0 \times 2^3 + 1 \times 2^2 + 0 \times 2^1 + 0 \times 2^0 = 148$$

2.5.2 BCD

BCD (Binary Coded Decimal) is two-decimal code. The encoding type represents a decimal number 0 to 9 with 4-bit binary number. Example 9 (Decimal) =1001 (Binary).

As easy to deal with, often use for BCD switch and BCD nixie tube display 由

Code Type	Word data range	Dword data range
BCD	0~9999	0~99999999

[Example]

Decimal data is +123, the binary data is 0000 0000 0111 1011 (64+32+16+8+2+1=123). But BCD data is #123, it can be simply expressed as 0000 0001 0010 0011

Decimal data is -413, the binary data is 1111 1110 0110 0011 (complement for negative number, negation adding 1). But BCD data is #F413, it can be simply expressed as 1111 0100 0001 0011

2.5.3 LSB

LSB is the acronym of Least Significant Bit. This encoding type first converts the data in the buffer to binary data, and then determines the current state of component based on the number of consecutive "0" at the least significant bits of the binary dat. [Example] Take the data with word address for example:

Decimal	Binary	State
0	0000 0000 0000 0000	All bit are 0, the state is 16
1	0000 0000 0000 0001	The number of consecutive "0" at least significant bits is 0, the state is 0
2	0000 0000 0000 0010	The number of consecutive "0" at least significant bits is 1, the state is 1
3	0000 0000 0000 0011	The number of consecutive "0" at least significant bits is 0, the state is 0
4	0000 0000 0000 0100	The number of consecutive "0" at least significant bits is 2, the state is 2
5	0000 0000 0000 0101	The number of consecutive "0" at least significant bits is 0, the state is 0
6	0000 0000 0000 0110	The number of consecutive "0" at least significant bits is 1, the state is 1
7	0000 0000 0000 0111	The number of consecutive "0" at least significant bits is 0, the state is 0
8	0000 0000 0000 1000	The number of consecutive "0" at least significant bits is 3, the state is 3

2.6 Language Switching

User can pre-register the content written in multiple languages to text library in Kinco HMIware. The switching display among the multiple languages contents can be realized by modifying the value of special register, which refers to LW9130 in Kinco HMIware.

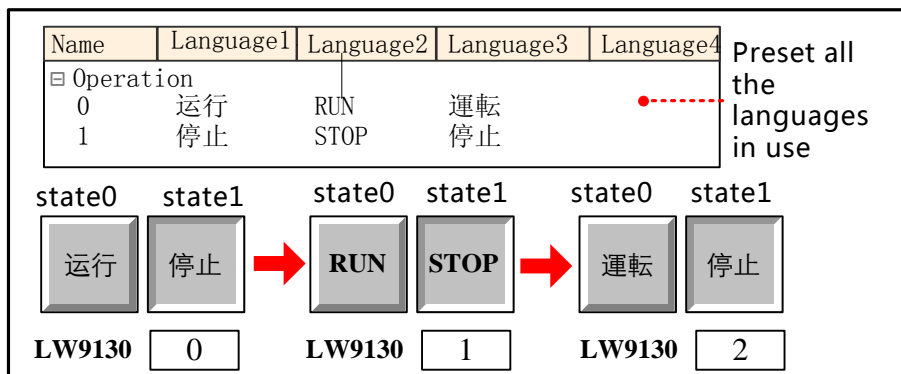

[For details about text library, refers to \[Advanced Part 5.1 Text Library\]](#)

There are two following usages for switching display among the multiple languages by LW9130.

- Use Multiple State Setting and Multiple State Display components.

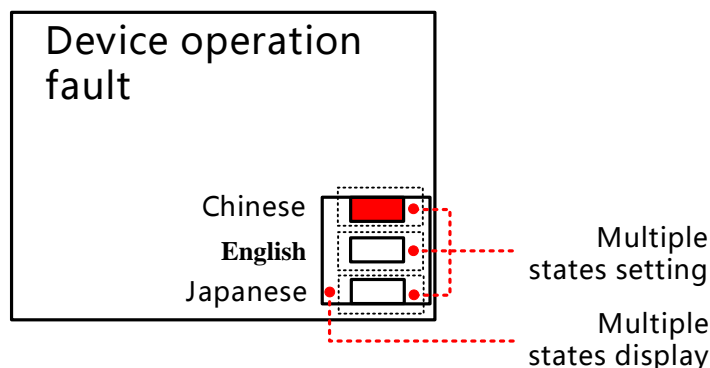

Create one Multiple State Display component, the attribute is:

Read Address	LW9130 (HMI system special register)
State Num.	3
Tag	No
Graphics	Use vector graphic, create one vector graphic with 3 state <div style="display: flex; justify-content: space-around; align-items: center;"> <div style="text-align: center;"> <p>State 0</p> </div> <div style="text-align: center;"> <p>State1</p> </div> <div style="text-align: center;"> <p>State2</p> </div> </div>

Three multiple state settings stack up upon a multiple state display in corresponding order, attribute settings:

Write Address	LW9130 (HMI system special register)
Setting Mode	Set Constant
Set Value	0/1/2
Tag	No
Graphics	No

[For details about component attribute, refer to \[Advanced Part 4 Component\]](#)

When running, the effect is as shown below:

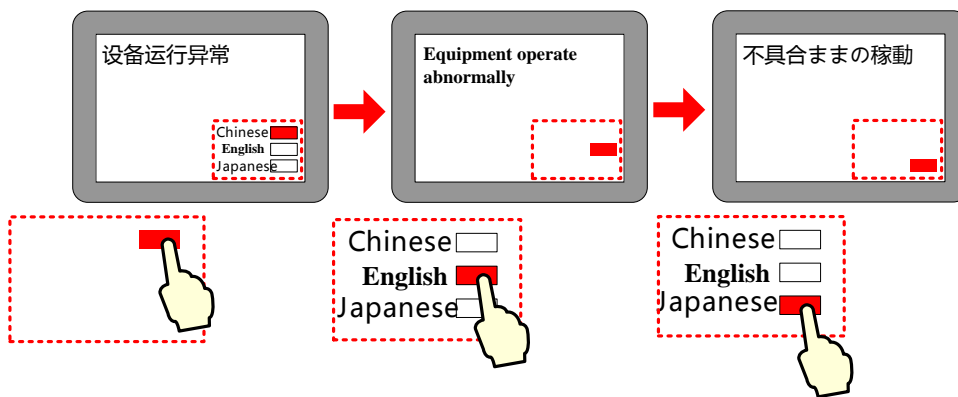

- Use Multiple State Switch

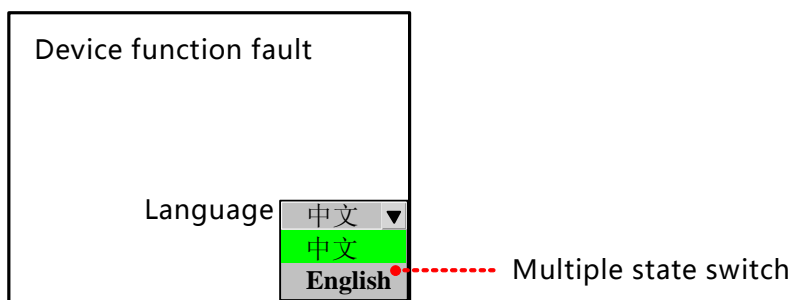

Create one Multiple State Switch component, the attribute is:

Read/ Write Address	LW9130 (HMI system special register)
Control Mode	Dropdown List
State Num.	3
Select/Background/Border Color	bright green/gray /lack
Tag	Use; 0: Chinese; 1: English; 2: Japanese
Graphics	No

When running, the effect is as shown below:

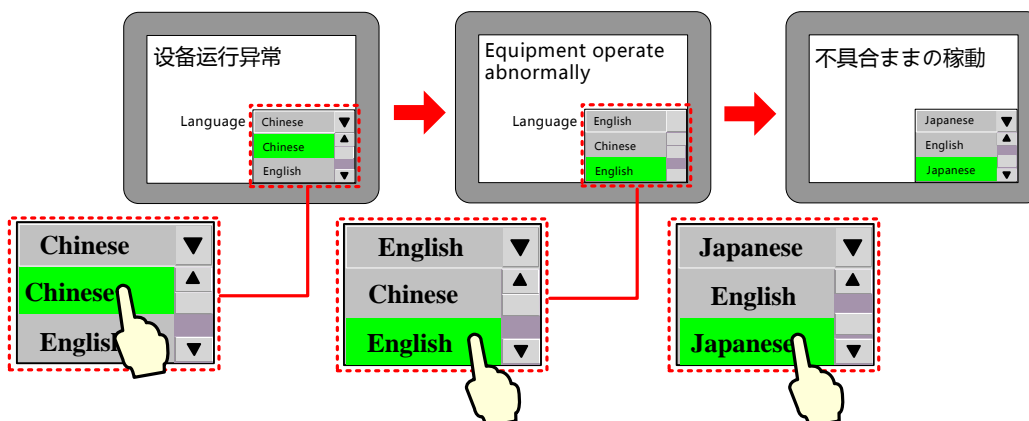

2.7 RTC Set

MT series HMI has real time (RTC) function, BIN coded format, for real time and date display. Once HMI is power off, battery is backup

In Kinco HMIware, components with real time clock: time, event display, event bar, historical event display, historical data display, operation log, trend curve ,XY plot.

So when using components above, you should ensure the accuracy of time or you may get wrong information

2.7.1 Through Special Registers

LW10000~LW10006:

Special Register	Address Type	Code Type	Descriptions
LW10000	WORD	BIN	Second, the effective value range from 0 to 59
LW10001			Minute, the effective value range from 0 to 59
LW10002			Hour, the effective value range from 0 to 23
LW10003			Day, the effective value range from 1 to 31
LW10004			Month, the effective value range from 1 to 12
LW10005			Year, the effective value range from 2000 to 2037
LW10006			Week, the effective value range from 0 [Sun] to 6 [Sat]

[Example]set year, month, date, minute, second, use 6 number input components as shown :

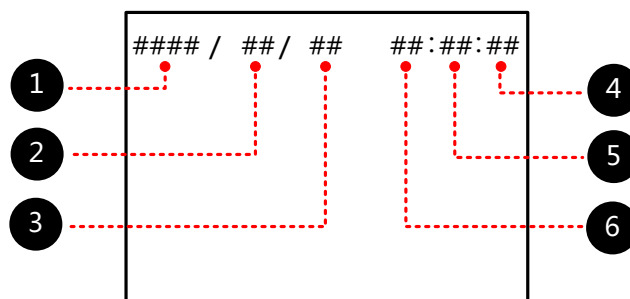

1 2 3 attributes:

Read/Write Address	LW10005 (HMI system special register)	LW10004 (HMI system special register)	LW10003 (HMI system special register)
Integer	4	2	2
Min/ Max	2000/2037	1/12	1/31
Alignment	Left	Leading 0	Leading 0
Font Color	Black		
Graphics	No		

4 5 6 attributes:

Read/Write Address	LW10002 (HMI system special register)	LW10001 (HMI system special register)	LW10000 (HMI system special register)
Integer	2	2	2
Min/ Max	0/23	0/59	0/59
Alignment	Leading 0		
Font Color	Black		
Graphics	No		

Input the real time to get the right time information:

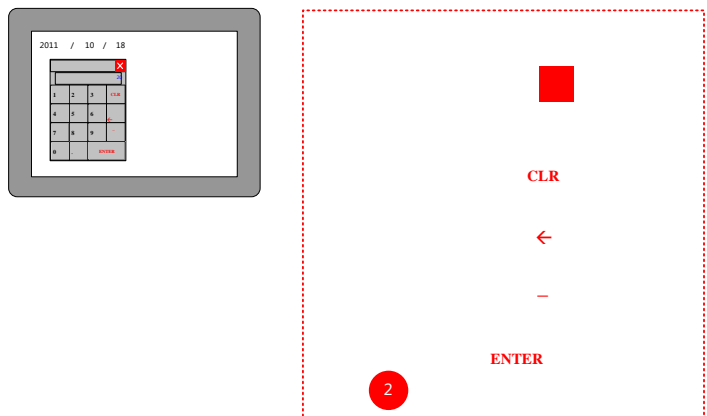

2.7.2 Calibrate System Time in System Setup Screen

Switch to system setting mode, modify time on this interface.

Take one HMI for example:

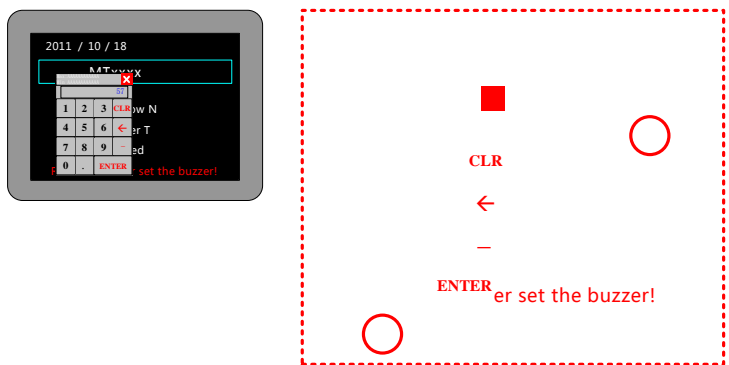

[More information refers to \[Hardware Part 3.1 Methods to Display System Setting Mode\]](#)

2.7.3 System Time and PLC Time Synchronization

There are two following way to make the system time and PLC CPU time synchronization:

- Use Data Transmission function of Timer component

In this way, we will use the Timer component to transfer the data in the time register of PLC to HMI system special register LW10000~LW10006.

[For details about Timer component, refers to \[Advanced Part 4.16.2 Timer\]](#)



Minimum execution cycle is 100ms, so there is an inevitable time deviation between HMI and PLC.

- Use The External Clock for Event

Only for trigger time and return to normal time of event (HMI time for acknowledge time).

Choose “use external time for event” - [HMI attribute]-[HMI extended attributes],related time will read from special

registers: LW9010~LW9017 , which get time by timer receiving from PLC CPU clock.

LW9010~9017:

Data Type	Code Type	Address	Descriptions	Address	Descriptions
WORD	BIN	LW9010	Second, the effective value range from 0 to 59	LW9014	Month, the effective value range from 1 to 12
		LW9011	Minute, the effective value range from 0 to 59	LW9015	Year, the effective value range from 1980 to 2079
		LW9012	Hour, the effective value range from 0 to 23	LW9016	Week, the effective value range from 0[Sun] to 6[Sat]
		LW9013	Date, the effective value range from 1 to 31	LW9017	Millisecond, the effective value range from 0 to 999



Minimum execution cycle is 100ms, so there is an inevitable time deviation between HMI and PLC.

[Example] Take FX2N PLC for example:

FX2N CPU clock

Addr. Type	Descriptions	Addr. Type	Descriptions
D8013	Second, the effective value range from 0 to 59	D8017	Month, the effective value range from 1 to 12
D8014	Minute, the effective value range from 0 to 59	D8018	Year, the effective value range from 1980 to 2079
D8015	Hour, the effective value range from 0 to 23	D8019	Week, the effective value range from 0[Sun] to 6[Sat]
D8016	Date, the effective value range from 1 to 31		

① Select “Use External Time for Event” in [HMI Attribute]-[HMI Extended Attributes].

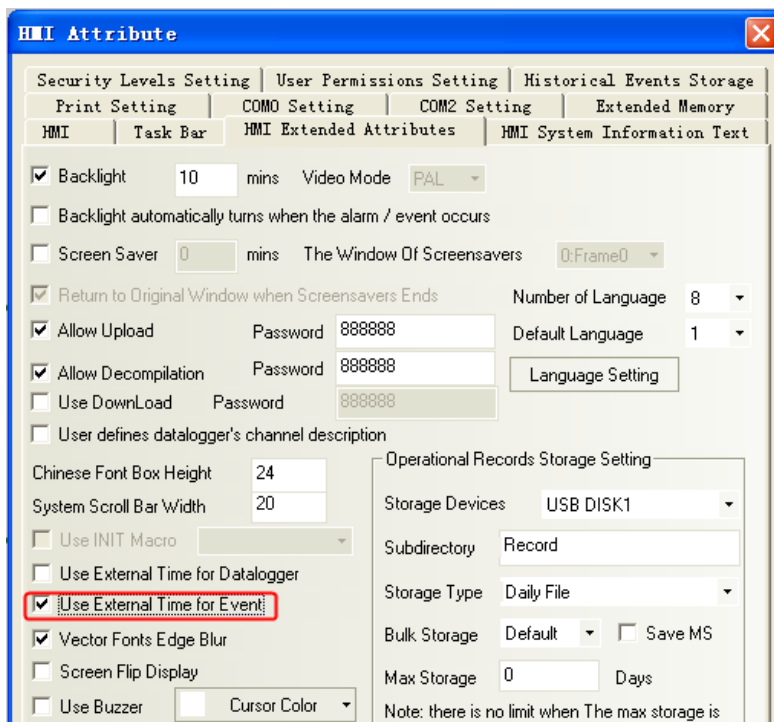

2 Add the needed event to Event Information List.

No.	type	HMI No.	PLC inform..	Addr	triggering	condition	text
0	0	1	HMI0:PLC0:	D:0		>100	Abnormal Temp.

Input all the event information in Event information list

For details about event information logon, refers to [Advanced Part 4.15.3 Event Information]

3 use a event display to display information written in event information list.

attribute:

Read Address	LW 0 (HMI Local Register)	
Format	Sequence No.	
	Event Trig Time	
	Acknowledge Time	
	Return to Normal Time	
	Standard Time Format (H:M:S)	
	Extended Date Format (Y/M/D)	

4 use a timer to transport data from PLC to HMI

attribute:

Execution Cycle	1 × 100ms	
Data Transmission	Source Address	Destination Address
	SD 8013* (PLC register)	LW 9010 (HMI system special register)
Data Type	Word	

Data Transmission	6(word)
-------------------	---------

※ FX2N PLC D8000~D8255 corresponding to HMI SD8000~SD8255.
 value in D0 is larger than 100:

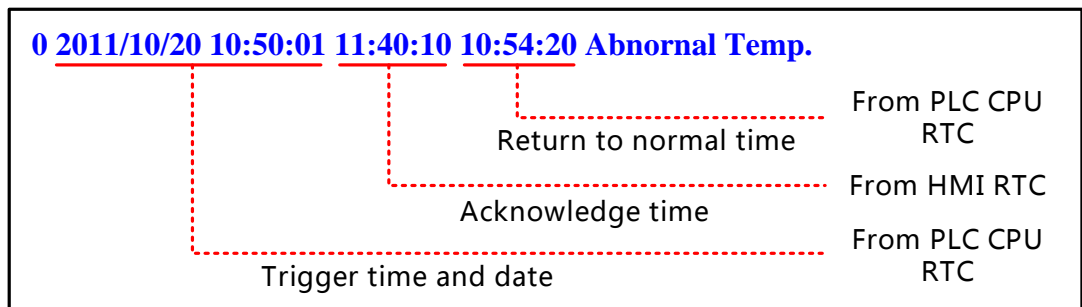

2.8 LOGO Screen (Logo)

LOGO screen is the screen that appears during the startup of HMI. LOGO screen can be customized by users.

2.8.1 LOGO Screen Specification

The specification of LOGO screen

HMI models	Max size (pixel) (Width × Height)	Picture format
MT4424T/TE	800 × 480	Jpg, bmp, gif and so on
MT4414T/TE		
MT4620TE	800 × 600	
Others	Width × Height < 131000	

2.8.2 Init Screen Setting

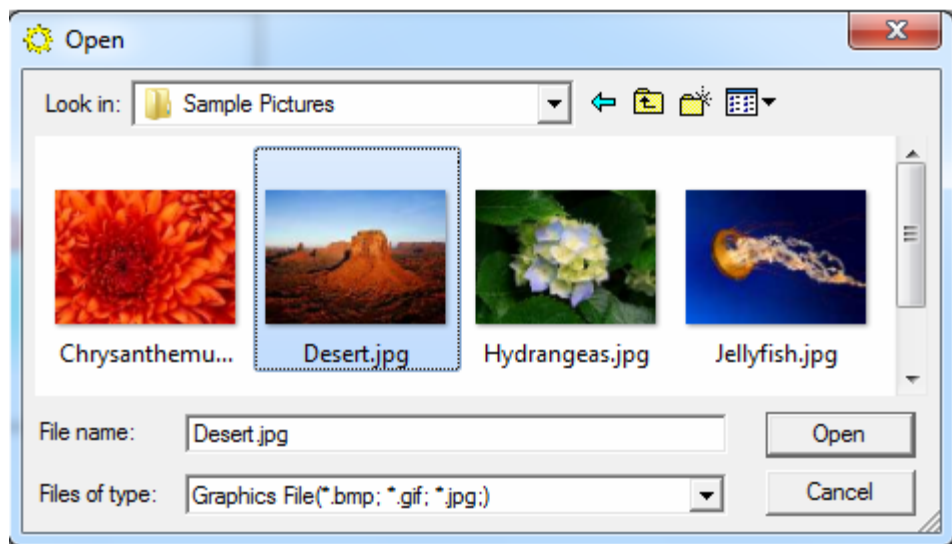

- Change initial window:

Graph instrument	step
------------------	------

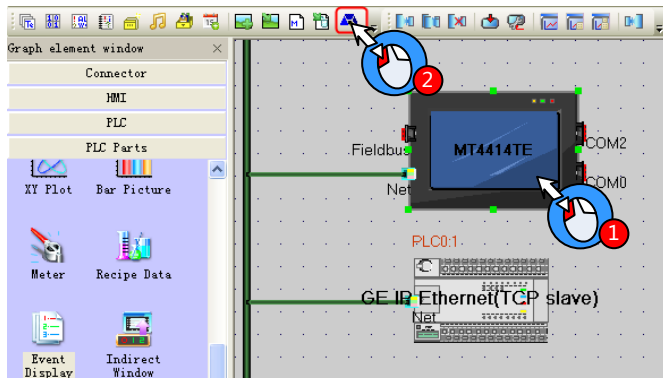

1 Select the HMI to be set LOGO screen in Construct Window.

2 Click the  icon in Toolbar.

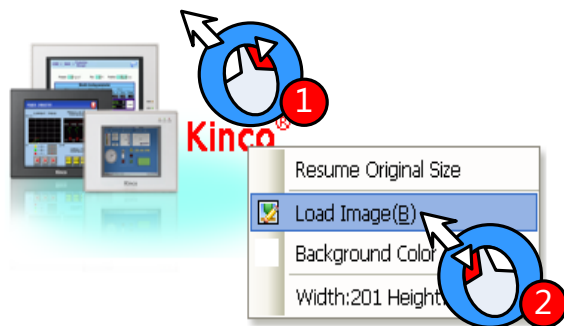

1 Right-click in the editing space after entering the LOGO screen setting window.

2 Select "Load Image"

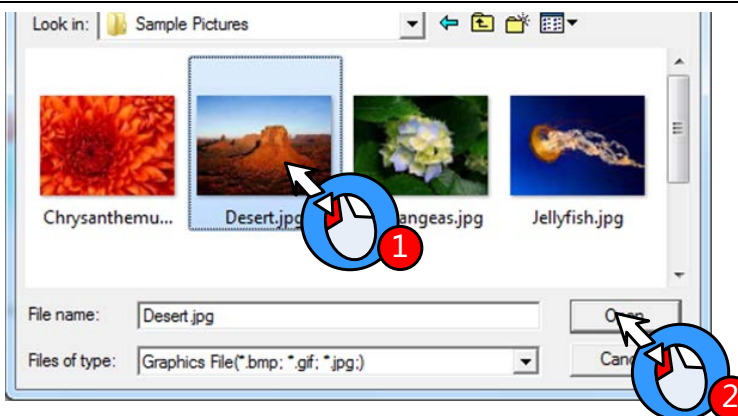



1 There are will pop up [Open] dialog box, user can find the path of picture to be imported and select the picture.

2 Click [Open] button.

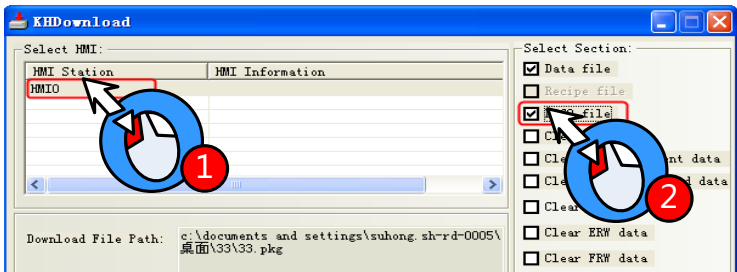

LOGO Screen is set successfully.



- ① HMI Click the  icon in the toolbar, and pop up the [KHDownload] dialog box, then select the HMI to be downloaded the LOGO screen.
- ② Select the [LOGO file] and click the [Download] button that means the LOGO screen will be downloaded to the HMI.

The method for not showing LOGO:

Open [KHManager]-[Download Operate] and select “Unshow LOGO”, then click the [Set] button. If the setting is successful, [Set Successfully] dialog box will appear. And then LOGO screen will not appear during the startup of HMI next time.

[For details about KHManager, refer to \[Advanced Part 8 KHManager\].](#)

2.8.3 Note for Using Init Screen

Pictures for initial screen should keep in allowed size.

2.9 Exchange Serial

By “exchange serial 0 and serial 1” ,all the devices connected to these two ports along with their parameters will be exchanged without bothering to reset.

In Kinco HMIware construct window select the HMI which to exchange serial, right-click and select "Exchange serial 0 and serial 1 ", as shown below:

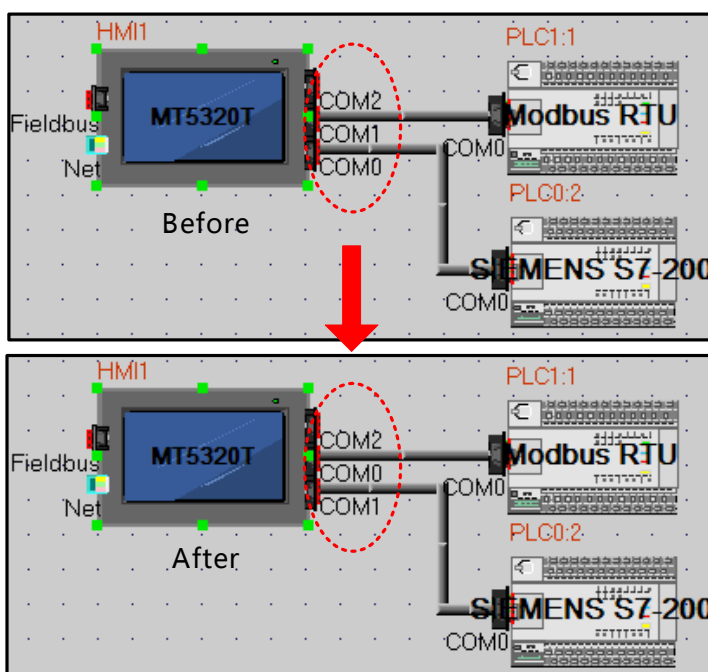
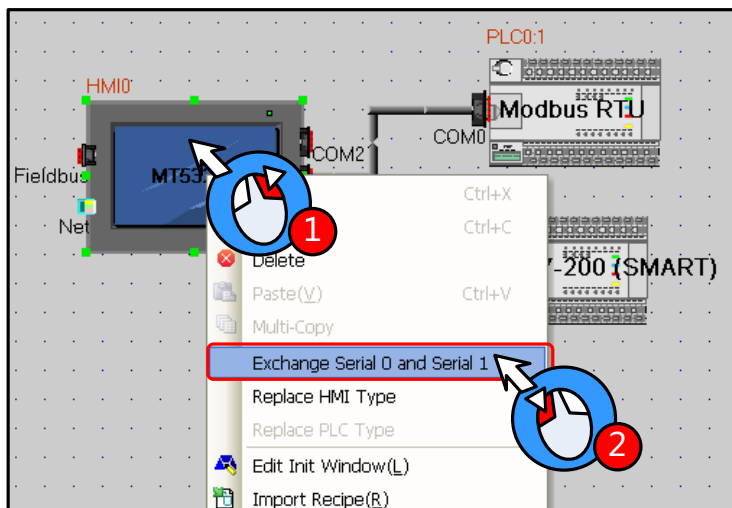

Exchange serial function is only applicable to COM0 and COM1, are not suitable for COM2

2.10 Replace Devices

In the industrial field, we often need to change devices. Kinco HMIware has shortcuts to make it.



Note

HMI replacement must be carried out through the [Replace HMI Type] option, and if it is done by getting the original HMI deleted and then a needed HMI type created, the original project screen will be lost.



Note

PLC replacement must be carried out through the [Replace PLC Type] option, and if it is done by getting the original PLC deleted and then a needed PLC type created, the PLC address type set in the original project will be replaced by the HMI local address.

2.10.1 Replace HMI

Select a HMI icon and right-click it in the Construct Window of Kinco HMIware, and then click “Replace HMI Type”, as shown below:

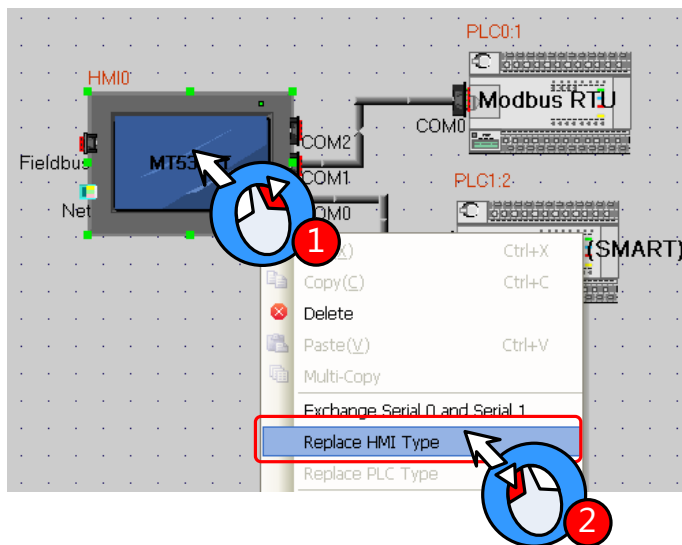

Then, the [Replace HMI Type] dialog box will pop up:

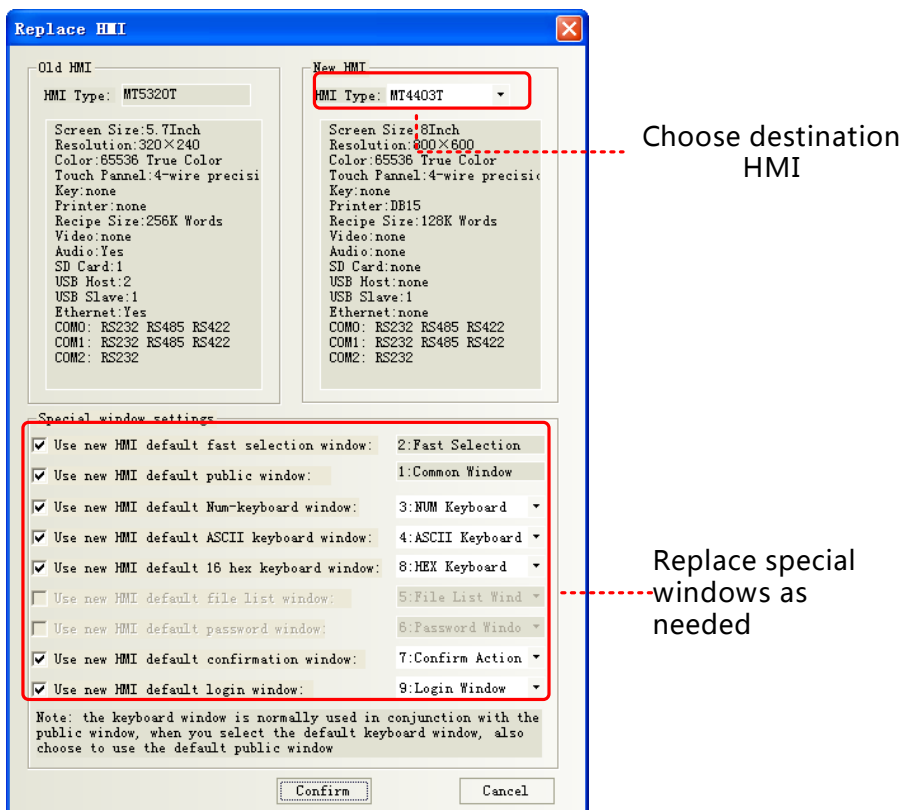

Choose the HMI you want in [new HMI]-[HMI type],If resolution ratio of the two differ a lot ,it is suggested to choose all the special windows ,or the old ones are in use. Click OK to finish.



1. Replace a HMI with 3 serials with one with 2,you should connect the device to COM0 or COM1 if it is once connect to COM1.Otherwise ,replacement won't be allowed.
2. HMI with Ethernet can only replaced by one has too
- 3.Once the new HMI type doesn't support components in the old ones, all them will disappear automatically.
4. If resolution ratio of the two types are different size of component will be enlarged or narrowed, excluding word size..

2.10.2 Replace PLC

Select a PLC icon and right-click it in the Construct Window of Kinco HMIware, and then click “Replace PLC Type”, as shown below:

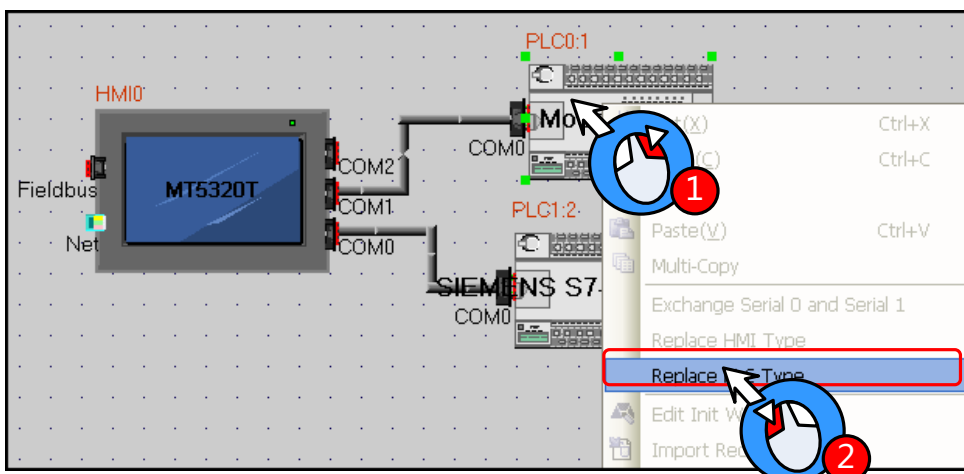

Then, the [Replace PLC Type] dialog box will pop up:

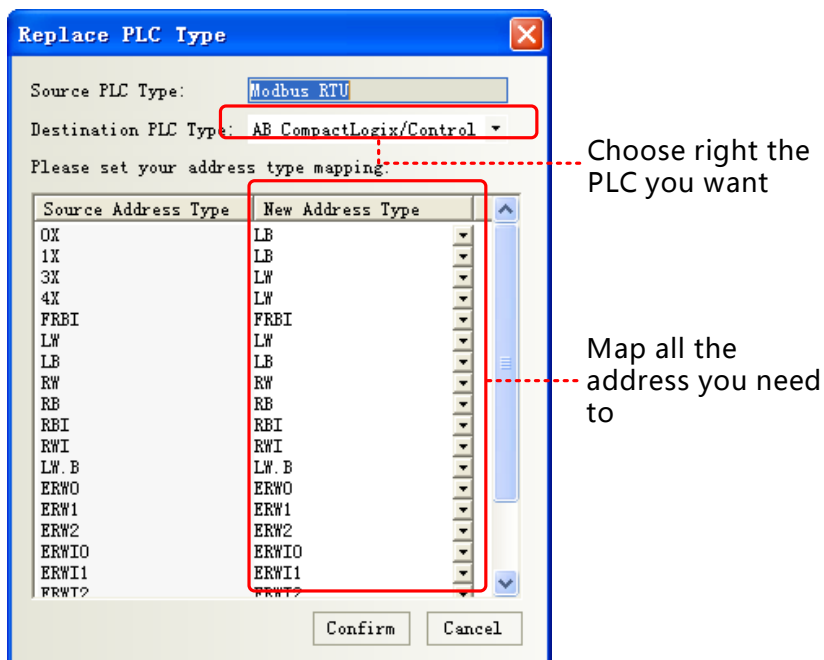

The user can select the replace PLC type in the pull-down list of the destination PLC type, and the user select new address types in address type mapping list according to the address type relationship between source PLC type and destination PLC type.

2.11 Index Function

2.11.1 Index Register

We can change operator address by changing value of a register. In this way, we call this register index register. Real address=initial address + value of index register. After using index register, only the real register value will be modified, not the initial one.



Some backgrounders including event information logon, alarm information logon, PLC control, macro ,trend curve, XY plot, oscilloscope do not have this function.

[Example]

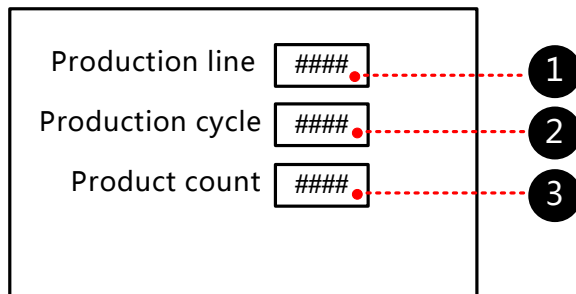

① Number Input component, the attribute is:

Read/Write Address	LW 0 (HMI local register)
--------------------	---------------------------

② Number Display component, the attribute is:

Read Address	D 100 (PL C register)
--------------	-----------------------

Index Register	select: LW 0
3 Number Display component, the attribute is:	
Read Address	D 200 (PLC register)
Index Register	select: LW 0

You can check all the product indicator data by input line number

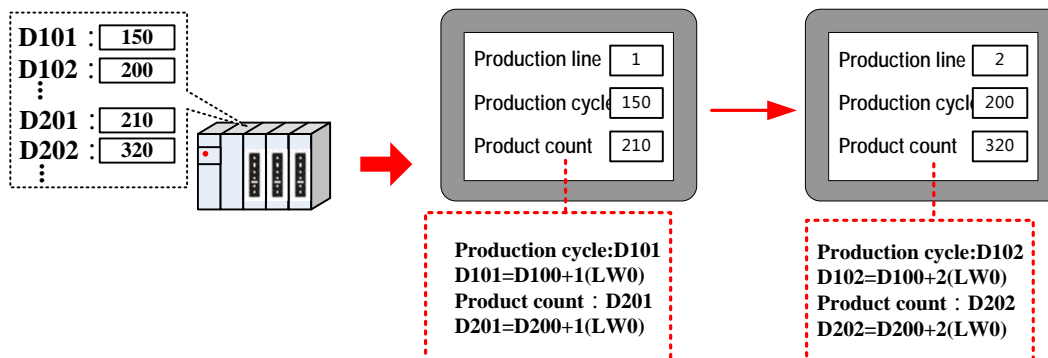

2.11.2 Index Station Num

When HMI communicates with more than one PLC through one port, it usually needs to drag many PLCs on the screen. If there are a lot, it will be a little crowd. In order to avoid it, user can make it by [change station num].

When editing a project, only one PLC is dragged out, by change choose [change station num] in component attribute, you can switch to different station PLCs.

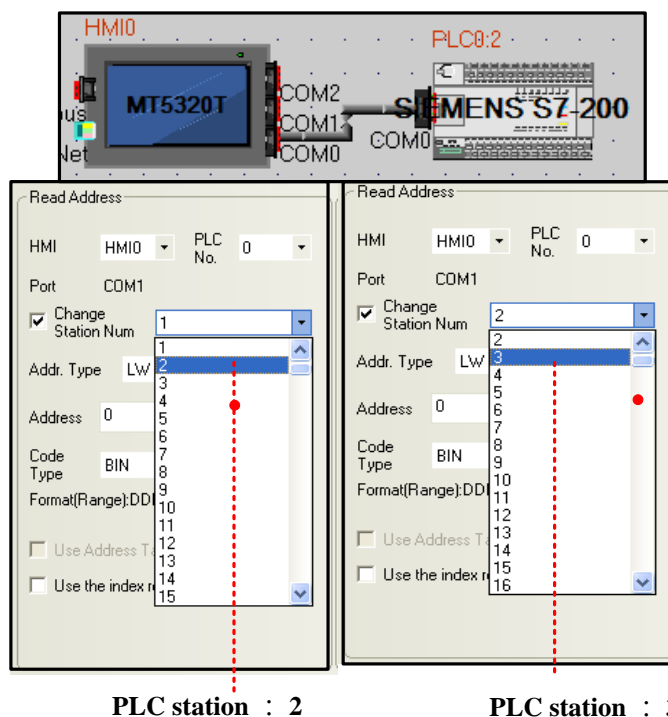

0 ~ 255 station ID, special registers LW9416 ~ LW9431

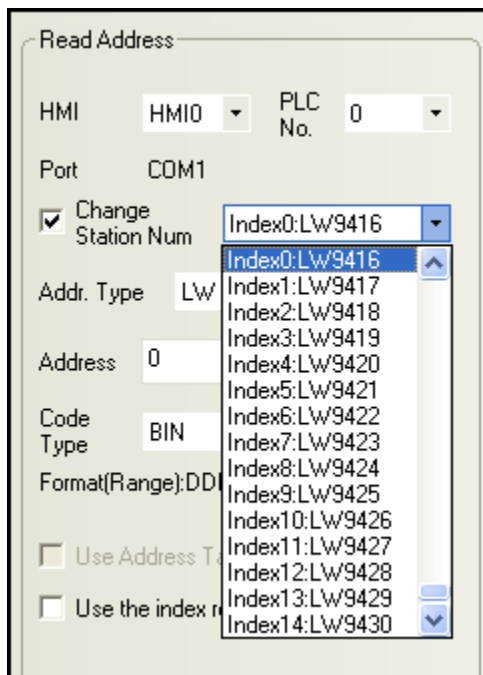

1. Some backgrounders including event information logon, alarm information logon, PLC control, macro, trend curve, XY plot, and oscilloscope do not have this function.
2. Special register index station ID, 16 different number devices to max on one screen .

[Example]

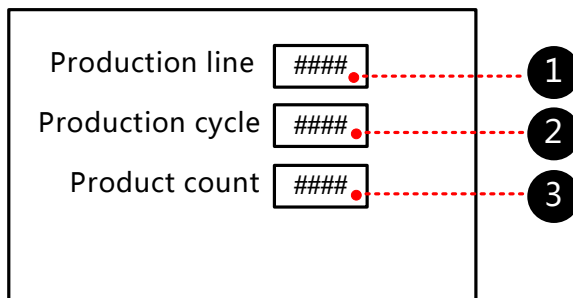

① Number input, attribute:

read/write address	LW 9416 (special register)
--------------------	----------------------------

② Number display, attribute:

Read address	D 100 (PLC register)
Change station num	Index0: LW9416

③ Number display, attribute:

Read address	D 101 (PLC register)
Change station num	Index0: LW9416

You can check all the product indicator data by input line number

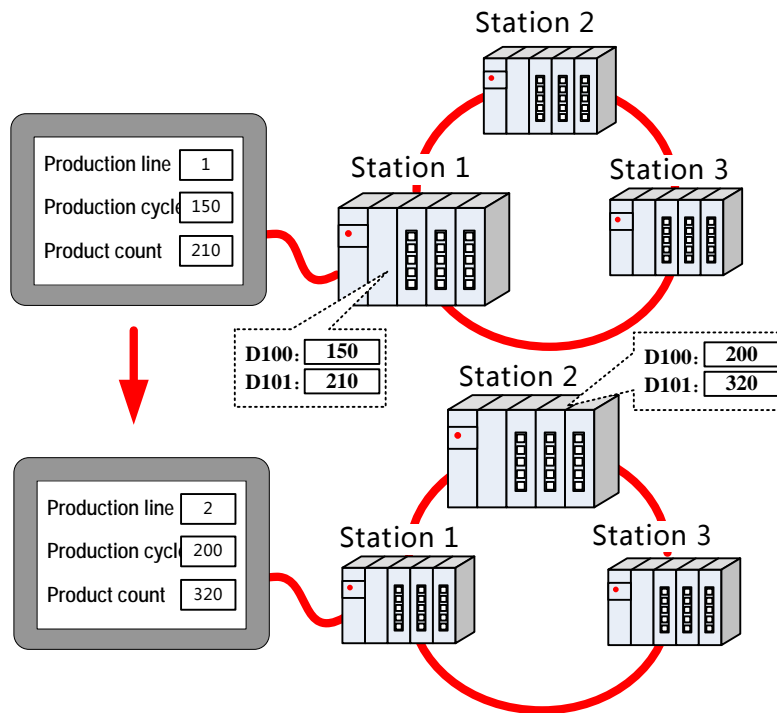

2.12 Buzzer

Buzzer is built HMI body, and can issue a "beep" sound device. The buzzer is usually used for touch and alarm.

2.12.1 Touch Beep

Touch beep means that when user touches the screen components, the buzzer will issue a "beep" sound.

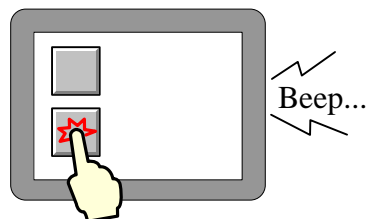

Enabling and disabling the touch beep can be achieved through the following three ways:

- Set in [HMI Attribute]-[HMI Extended Attributes]:

Check the "User buzzer" means that enable the buzzer sounds, as shown:

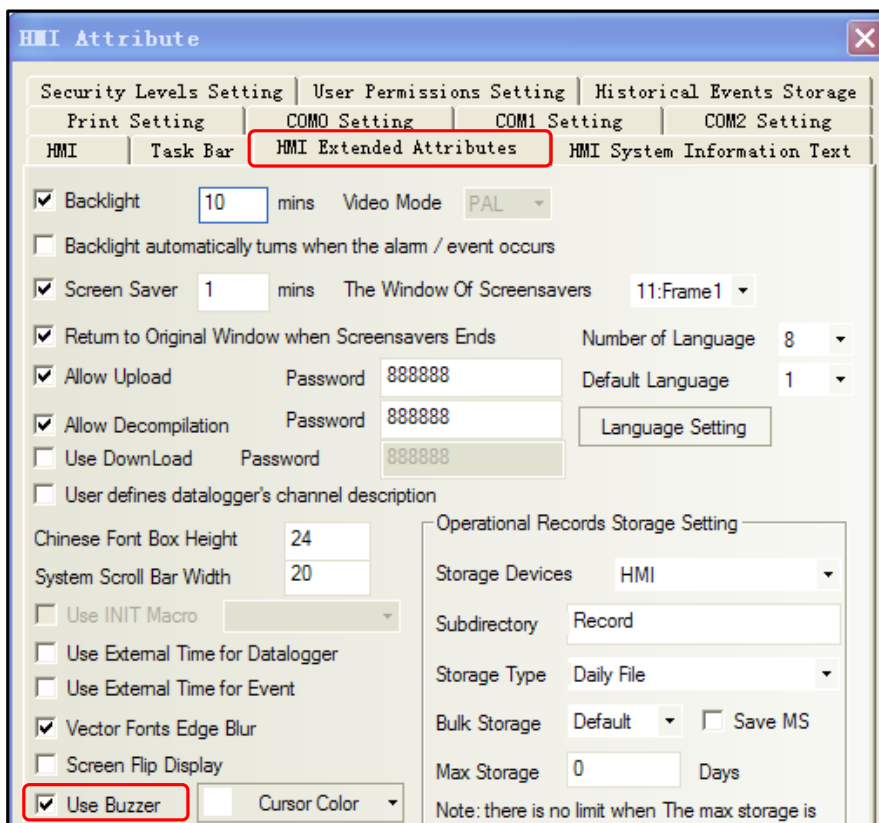

Save, compile and download to the HMI, then setting can take effect.

- Set in system setting mode

Switch to system setting mode, and set the buzzer enable or disable.

Take a HMI for example:

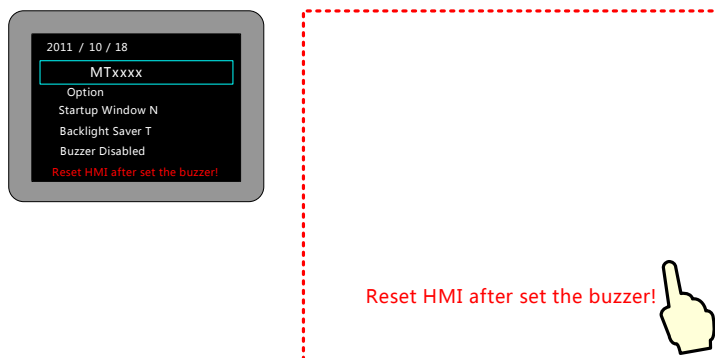

[More information refers to \[Hardware Part 3 System Setting Mode\]](#)

- Change the value of LW10012 to make buzzer enable or disable.

LW10012 Specific instructions as shown in table:

System Register	Descriptions
LW 10012	0:buzzer disable; 1: buzzer enable

2.12.2 Alarm Beep

When item logon in the alarm information or event information is triggered, HMI will beep.

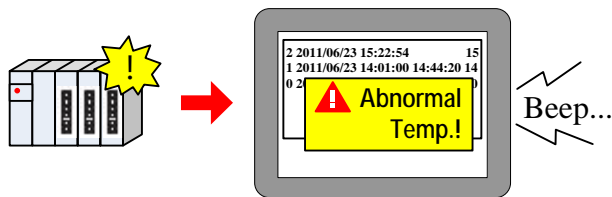

Choose “buzzer” as below:

Event

Triggered HMI: HMI0 Type: 0

Address: HMI HMI0 PLC 0

Port COM1

Change Station Num 1

Addr. Type LB Addr. 0

Code Type BIN Data Type Bit

Format (Range): DDDD (0--9999)

Use Address Tag

Attribute

Event Triggering On Off

Condition 0

Value Range

Min Value 0

Trigger Function

Execute Macro

Pop-up Window 0:Frame0

Confirm Pop Trigger Pop

Write (Trig) 0 Write (Confirm) 0

Write (Resume) 0

HMI HMI0 PLC 0

Port COM1 Change Station Num

Addrtype LB 1

Addr 0 Addr. Tag Addr. Len 0

Format (Range): DDDD (0--9999)

Buzzer Buzzing Time 1 Sec.

Sound

Use Sound Select Sound

Alarm Information

Triggered HMI: HMI0 Type: 0

PLC Address: HMI HMI0 PLC No. 0

Port COM1 Change Station Num 1

Address Type LB Address 0

Use Address Tag Format (Range): DDDD (0--9999)

Address Tag List

Attribute

Trigger: ON OFF

Use Buzzer Buzzing Time: 1 Sec.

Text

Content

Use Text Library Text Library

Language: Language1 Font

Event information list

Alarm information list

Users can choose buzzing time ranging from 1 to 65535, unit: second

User should set value of LB9141 to shut off the buzzer:

Special register address	Specification
LB 9141	ON: shut off buzzer , reset to 0

2.13 Screen Saver

Use a screen saver function can effectively prevent the screen in a important frame by inadvertently touch screen causes disoperation.

Screen saver function is enabled in the [HMI Attribute] - [HMI extended attributes]:

HMI Attribute

Security Levels Setting | User Permissions Setting | Historical Events Storage

Print Setting | COM0 Setting | COM1 Setting | COM2 Setting

HMI | Task Bar | HMI Extended Attributes | HMI System Information Text

Backlight 10 mins Video Mode PAL

Backlight automatically turns when the alarm / event occurs

Screen Saver 1 mins The Window Of Screensavers 11:Frame1

Return to Original Window when Screensavers Ends

Number of Language 8

When the HMI screen in the set period of time without touched, the screen will switch to the specified window that screensaver window.

If the screen saver window is a non-fixed value, you can change the value of the special register LW9532 to change

screensaver window number.



1. Screen saver time range from 1 to 65535, unit is minute; if set to 0, it means does not use the screen saver function.
2. Check the "Return to original window when screensavers ends", which means that when the system enters screen, if there are touch-screen operation, the system will switch back to the previous window into screensavers. Uncheck it means to continue to stay in the screensaver window, you need to set window switching element to switch screen.

2.14 Password Setting

Kinco HMIware security function includes project protect, screen protect and component protect.

2.14.1 Project Protection

- project protection: before you can open a project ,you should input password
- Project password protection:
- Upload protect: before uploading ,you should input a password
- Project upload protection:

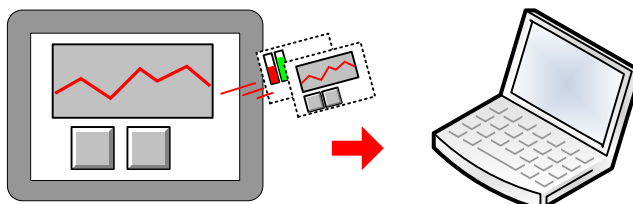

After input upload password

- Project decompile protection: when turning pkg into wpj, you should input a password
- Project decompile protection:

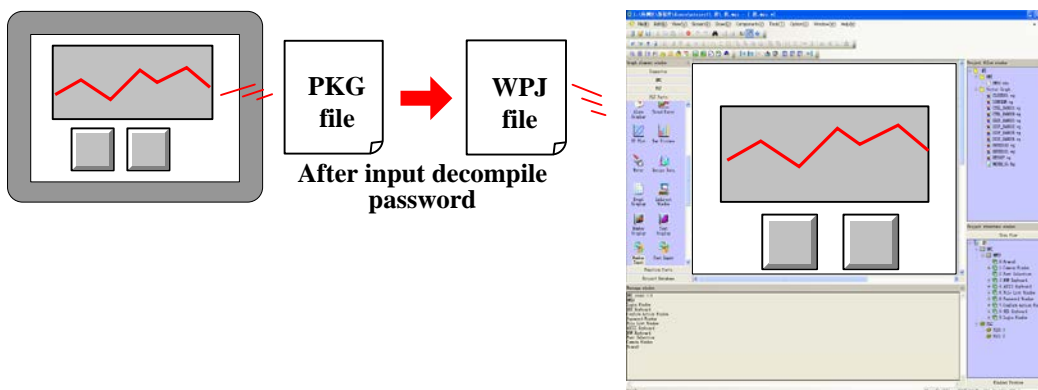

2.14.2 Screen Protection

You can set security levels or user permissions to limit operator from entering some important windows.

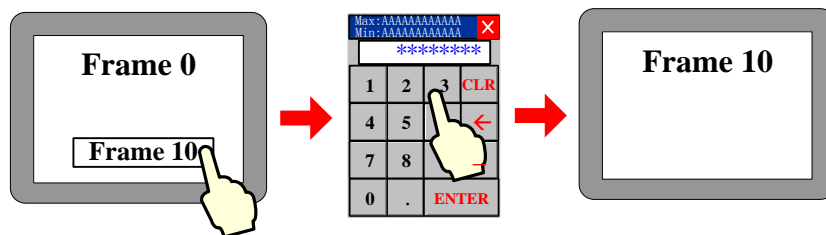

- security levels to protect screen

Set number of security levels and relevant password in [HMI attribute]-[security levels].

There are two ways:

Take window A switching to window B for example:

- Window security level

Window security level is set to 0(default), Window B security level is set to 1, then window A can be switched to window B when the system security level is equal or up to 1. So user must input the 1 or up 1 level password before switching the window.

About password window:

User can pop password window with the help of direct window, while function key will be used to switch the state of it. User can also create a new window or call the system one[Frame9:Login Window].

- Set the control authority

Set control setting to the component changing window. Choose “conditional enable” in [attribute]-[control setting]-[Touching enabled setting], select “security level” , set minimum level:1(or higher than 1).Then only users whose level is not less than 1can operate this component.

- screen protection through user permission

You need first to assign authority in [HMI attribute]-[user permissions setting]

Then you can set control setting of a component to implement this function.

Choose “conditional enabling” in [HMI attribute]-[control setting]-[touching enabled setting],select “permission control” , “select permission” :1 (for example).

Only user who has permission 1 can use this component. User can input its name and password to get the permission.

About login window:

User can also create a new window or call the system one [Frame9: Login Window].

2.14.3 Component Protection

In Kinco HMIware, you can limit others to operate some important components by set security levels or user permissions.

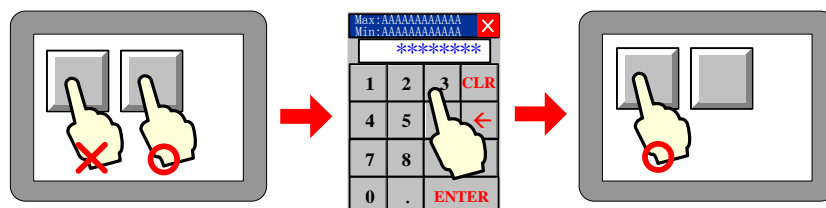

In two following ways you can protect components from being used without allowance:

- Through Security Level
- Through Permission Control

[For details about password, refers to \[Advanced part 10 Password\]](#)

2.15 Data Encryption

For the data stored in the external memory – USB disk\ SD card, data encryption function can be used to limit the user to make modification, editing and so on to the data files as CSV format.



1. If the [data decryption] operation is not performed to the CSV file generated for the component using [Data Encryption], the illegible characters will be displayed in the opened CSV file.
2. If the data is decrypted through KHManager, the CSV file can only be opened for viewing instead of modifying or editing.
3. If the encrypted file is modified by someone intentionally, the error prompt will appear during the [Decompile] operation in KHManager, making the damage of source file informed to the user.
4. The components supporting [Data Encryption] function are trend curve, XY plot, historical data display components.

Take the setting method of [Data Encryption] for sampling data file of the Trend Curve as example:

(1) [Trend graph component attribute] - [Save historical data] - Select [Save to external device] - Select [Data Encryption].

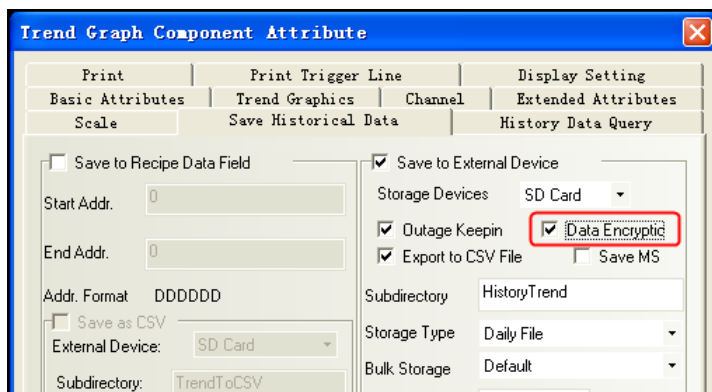

(2) The illegible characters will be displayed in the generated CSV file after the encryption if it is directly opened.

	A	B	C	D	E
1	TIME	CHO			
2	(2IY1}嫵	聃			
3	(2IY1}劔	聃			
4	(2IY1}厥	聃			
5	(2IY1z寫	細職			
6	(2IY1z嶮	統職			
7	(2IY1z枕	璫職			
8	(2IY1z弼	職			
9	(2IY1z堯	樞職			

Choose[data encryption]

	A	B	C	D	E
1	TIME	CHO			
2	10:57:37	11			
3	10:57:38	22			
4	10:57:39	33			
5	10:57:40	44			
6	10:57:41	55			
7	10:57:42	66			
8	10:57:43	77			
9	10:57:44	88			

Not use[data encryption]

(3) Open the KHManager software to decrypt CSV file.

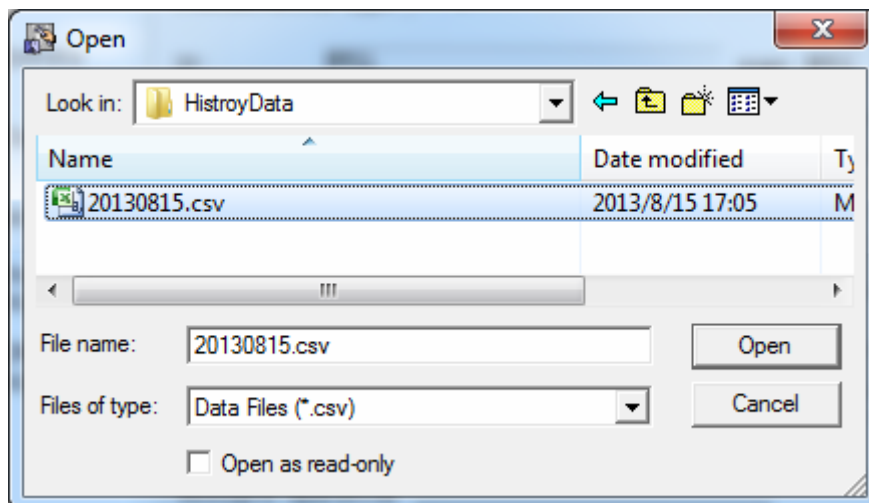

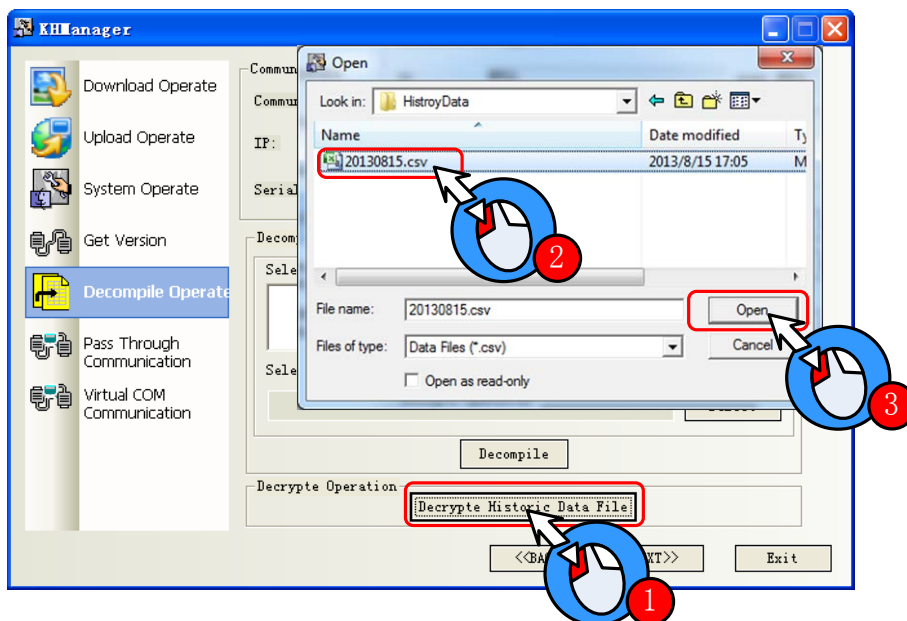

The following dialog box will pop up after the successful decryption.

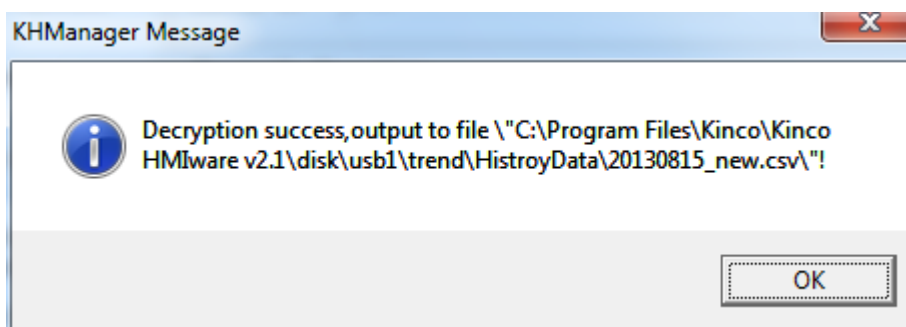

The display effect of the CSV file decrypted successfully is as shown below.

	A	B	C	D	E
1	TIME	CHO			
2	10:57:37	10			
3	10:57:38	20			
4	10:57:39	30			
5	10:57:40	40			
6	10:57:41	50			
7	10:57:42	60			
8	10:57:43	70			
9	10:57:44	80			

2.16 Animation Effects

In Kinco HMIware, user can make the screen more vivid by using animation effects in three ways:

- using multiple state display component

By frequently switching some static pictures ,you can see a continuous effect .

[Example]multiple state display making animation effect of an air blower

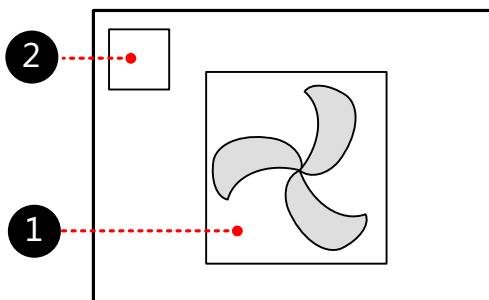

① multiple state display, making animation effect of an air blower, attribute:

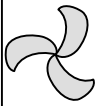
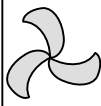
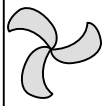
Read address	LW 0 (HMI local register)	
Move type	3	
Graphics	<div style="display: flex; justify-content: space-around; align-items: center;"> <div style="text-align: center;">State0 </div> <div style="text-align: center;">State1 </div> <div style="text-align: center;">State2 </div> </div> <p>Vector graphics:</p>	

② timer, change values of multiple state display, attribute:

Execution Cycle	1 × 100ms	
State Setting	Mode	Periodical JOG++ (circle)
	Date Type	word
	Asc value	1
	Upper	2
	Addr. Type	LW 0 (HMI local register)

When the project is run, the effect is as shown:

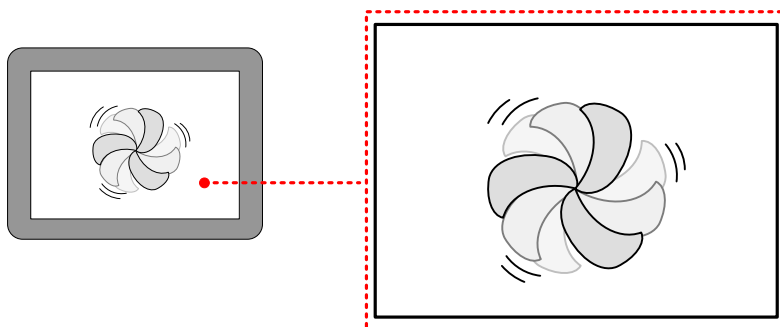

[More information refers to \[Advanced Part 4.3.2 Multiple State Display\]](#)

● Animation

By changing values, component can move from one position to another, so user will see a continuous action effect.

[Example]animation making conveyer belt effect

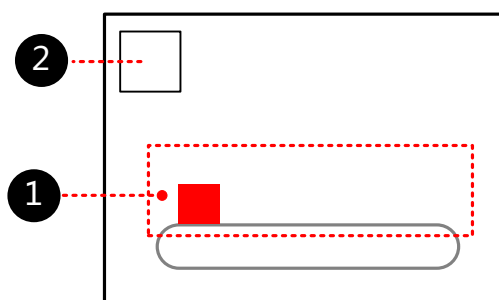

① ambition, attribute:

Read address	LW 0 (HMI local register)
Graphics	<p style="text-align: center;">State0</p>  <p>Vector graphics:</p>

② timer, change values of presupposed path, attribute:

Execution Cycle	1 × 100ms	
State Setting	Mode	Periodical JOG++ (circle)
	Date Type	word
	Asc value	1
	Upper	3
	Addr. Type	LW 1 (HMI local register)

When the project is ran, the effect is as shown:

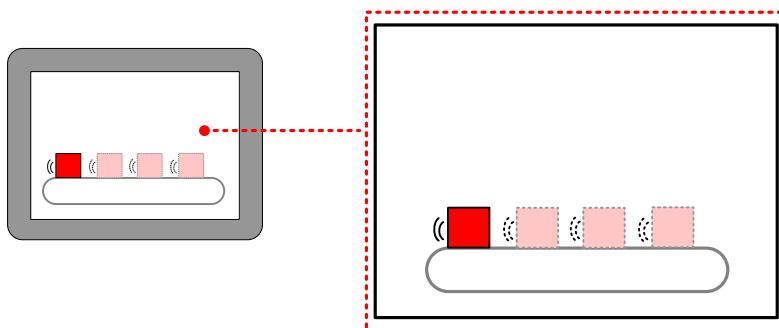

[More information refers to \[Advanced Part 4.12.1 Animation Components\]](#)

- Moving component
 - By changing values, component can move from one position to another ,so user will see a continuous action effect.

[Example] moving component making ball moving effect

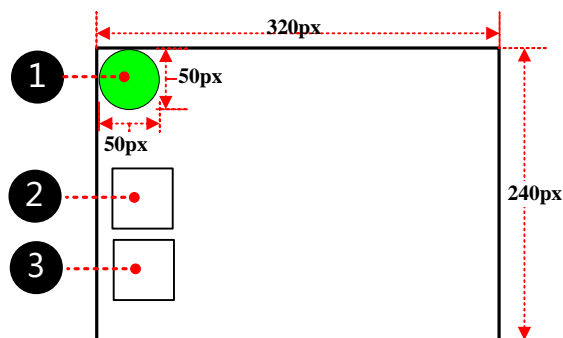

① Moving component property is set to:

Read address	LW 0 (HMI local register)
Move type	X & Y axis
Graphics	<p style="text-align: center;">State 0</p>  <p>Vector graphics:</p>

② Timer element, used to change the X-direction coordinate values of moving element, property is set to:

Execution Cycle	2 × 100ms
-----------------	-----------

State Setting	Mode	Periodical Bounce (turnover upon limit)
	Date Type	word
	Step	1
	Upper	0
	Lower	270 (320-50)
	Addr. Type	LW 1 (HMI local register)

③ Timer element, used to change the Y-direction coordinate values of moving element, property is set to:

Execution Cycle	3 × 100ms	
State Setting	Mode	Periodical Bounce (turnover upon limit)
	Date Type	word
	Step	1
	Upper	0
	Lower	190 (240-50)
	Mode	LW 2 (HMI local register)

When the project is ran, the effect is as shown:

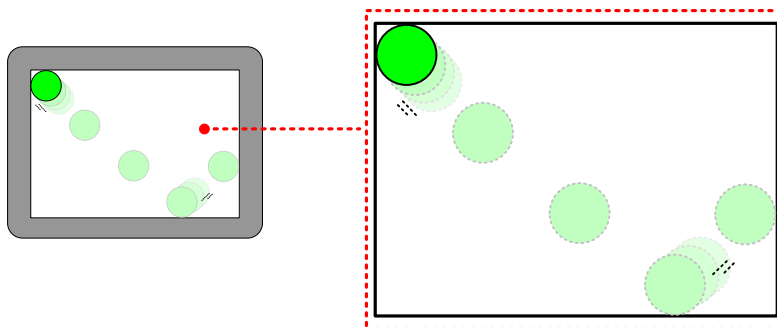

2.17 Multi-Copy

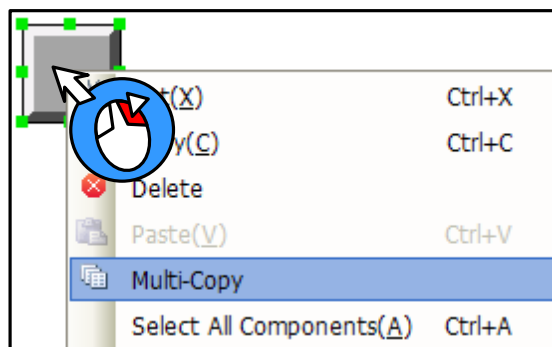

The method of multi-copy:

Select components, click the right mouse button and select [Multi-Copy], pop up multiple copies Properties window.

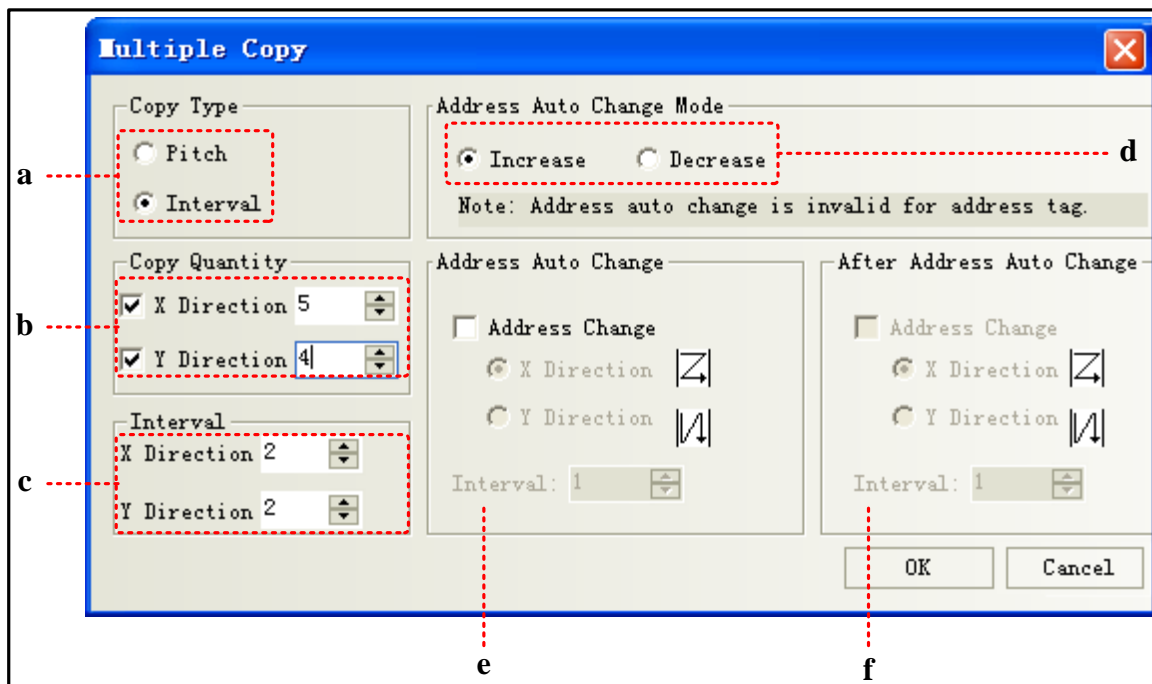

a: Interval makes the right border of the component as the start point to perform the copy. Pitch makes the 1st point in the upper-left corner of the component as the start point to perform the copy.

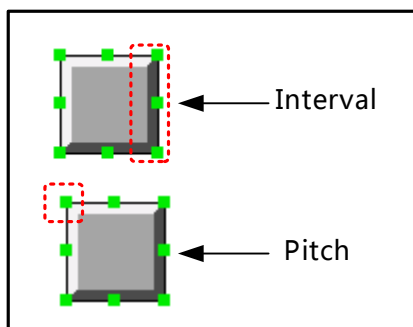

b: Copy quantity: Duplication elements quantity

c: Interval: The distance between the duplicated elements, in pixels

d: Increase/ Decrease: Address Increase or decrease

e: Address auto change: Integer bit register address auto increase or decrease

f: After address auto change: The register address after the decimal point auto increase or decrease

2.18 Group

Several components or the graphics are combined together and saved into the Group Components Library, thus making them called by other projects conveniently.

The format of Group Components Library is *.pgl.

- How to open [edit box of group components library]
 - Click [Draw] menu-[Group components]-[use the group element]
 - Right-click the mouse in the blank space of the window, select [Groups]- [use the group element], then the [edit box of group components library] dialog will pop up, as shown below:

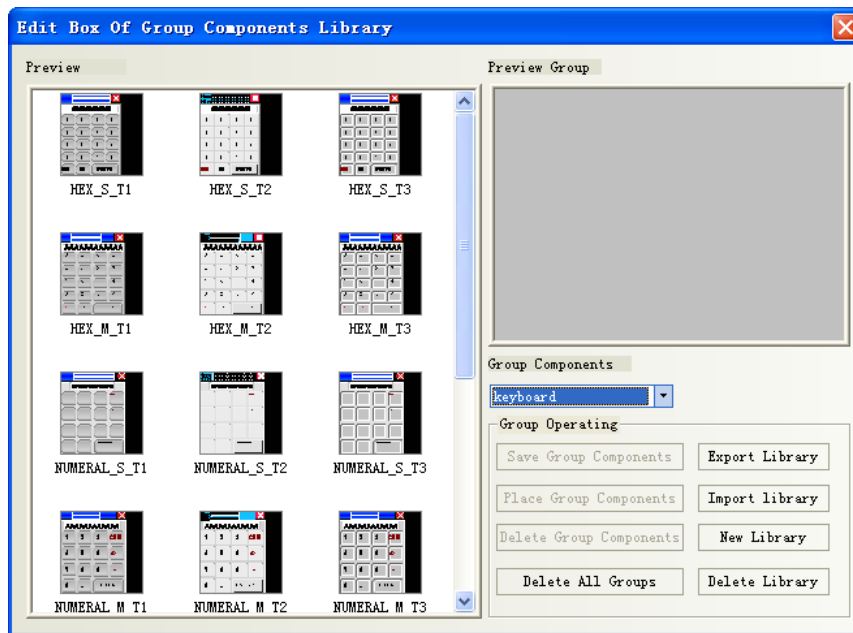

Name	Description
Export Library	Make the [Group Components Library] saved in the path defined by the user for convenient import.
Import Library	The default path of group components library is the userlib directory under the installation path of Kinco HMIware, and the user can also import the group components library from the self-defined path. Click [Import Library], and select the required group components library in the path corresponding to the saved group components library, then click [Open] to add this group components library to the group components library of the current project.
New Library	Click [New Library] button will make the dialog pop up, and the user can put the name of this new created group components library in it. The default path to save the group components library is the userlib directory under the installation path of the software.
Delete Library	Delete the group components library opened currently.
Delete All Groups	Delete all the graphics in the group components library opened currently.
Delete Group Components	Delete the selected graphics in the group components library opened currently.
Place Group Components	Place the selected group graphics in the group components library opened currently into the screen edited currently.

[Example]: How to add group graphics to a new created group components library is described as follows:

- (1) Click [use the group element] in [Group components] in [Draw], and click [New Library] after the Edit Box of Group Components Library pops up, and input "group" as the name of the group components library in the group component library name dialog box, as shown below:

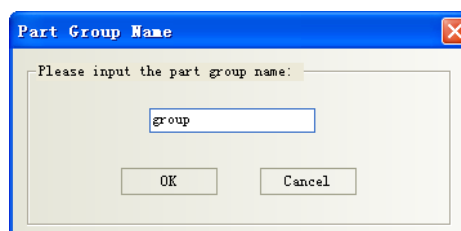

Click [Enter] to create an empty group components library as shown below:

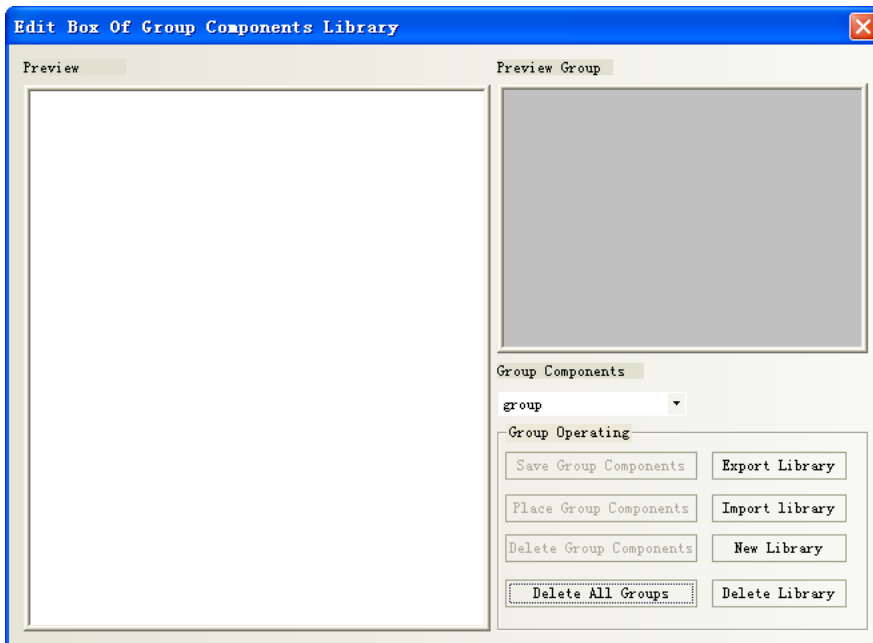

(2) Place 3 rectangles in the screen, as shown below:

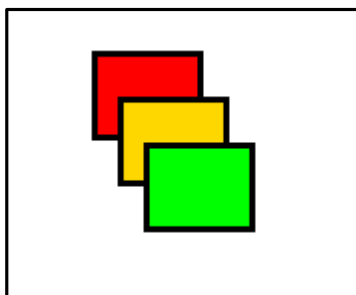

Selected these 3 rectangles, and right-click the mouse to select [Group]-[Save the group elements], and then click the [Save Group Components] button in the Edit box of Group Components Library dialog box to make the following dialog box pop up.

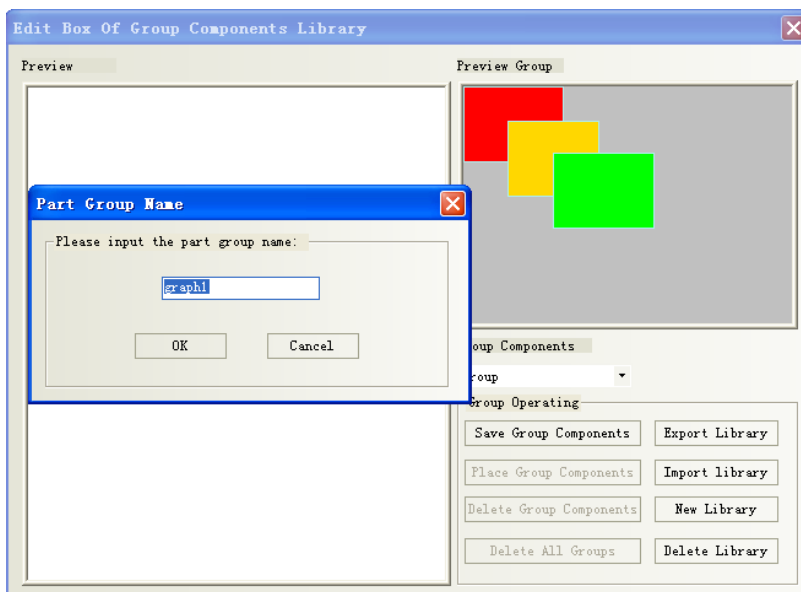

(3) Input “graph 1” in the Part Group Name dialog box, and then click [OK] button, then these 3 rectangles with the name of [graph 1] will be added into the new created group components library with the name of [group], as shown below:

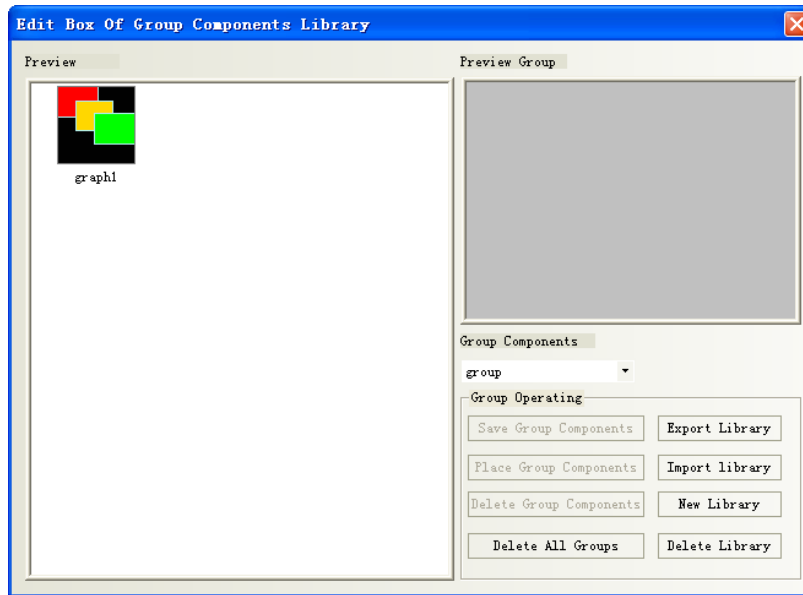

(4) If there are other group components to be added into the group components library with the name of [group], the operation method is the same as that mentioned above. And you just need to select [group] in the Group Components Library list as the path to save it.

2.19 Find /Replace

- Click [edit] menu-[find/ replace]
- Click the  icon on toolbar
- Press the PC keyboard shortcuts “CTRL” + “ F”

The following dialog box will pop up:

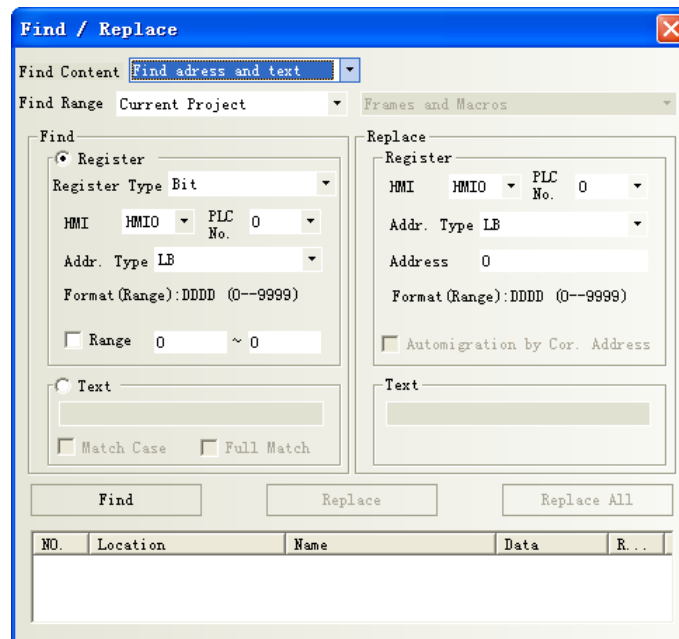

Name	Description	
Find Range	Current Project	All the frames, macros, background database in HMI will be searched.
	Background	Only the background database components, such as event information logon, alarm

	Database	information logon, trend curve etc. will be searched.	
	All HMI	Frames and Macros	All the frames and macros in current project will be searched.
		All Frames	All the frames in current project will be searched.
		All Macros	All the macros in current project will be searched.
	Current HMI	Frames and Macros	All the frames and macros in the selected HMI will be searched.
		All Frames	All the components in all the frames in the selected HMI will be searched.
		Current Frame	All the components in the current frame in the selected HMI will be searched.
		All Macros	Only all the macros in the current HMI will be searched.
Find	Register	Register Type	It means to find the device with Bit type or Word type.
		Addr. Type	It represents the device type and device address in the controller where the search is performed. Checking "Range" means the search will be performed in the set range of address.
	Text	Unselect match case/ full match	It means the judgment of the case of the characters and the consistency in the whole text will not be done during the search.
		Match Case	It means the match of the case of the characters in the text to be searched is required.
		Full Match	It means the match of the text to be searched in the whole text is required.
Replace	<p>After this option is set, the device type and address found according to the set conditions will be replaced by the specified device type and address. "Automigration by Cor. Address" in the Replace part will take effect once the "Range" in Find part is selected. If "Automigration by Cor. Address" is not selected, the replace address is the same; while if "Automigration by Cor. Address" is selected, the replace address is the consecutive address which will automatically deviate by making the set replace address as the start address. When the above parameters are set, if the "Find" button in the dialog box is clicked, the search of address meeting the condition will be performed the window locating in the Find Range. If the component is found, then No., Location, Name and Data will be displayed in the bottom white box. When the component meeting the requirements is found, the screen will automatically switch to the position where this component locates and the attribute dialog box for this component will pop up after this component is double-clicked. Clicking "Replace" or "Replace All" means the found component meeting the conditions will be replaced by the component with the address type and address set in the "Replace" part.</p>		

3 Window



Window is the basic element for HMI project, each screen is made of some windows. With window, you can place the various components, graphics, texts displayed on the HMI screen.

3.1 Window Types

According to the different of the function or using ways, there are 3 types of windows: Basic Window, Common Window and Fast Selection Window. The Basic Window after its size is changed can also be used as pop-up window. All the windows can be used as the bottom window. Specific descriptions are shown as below:

Window Types	Descriptions
Basic Window	This window is the most commonly used window. When Basic Window is changed by using [Function Key]-[change window] or [PLC Control]-[change window] function, the current screen will be cleared (All the windows rather than Common Window and Fast Selection Window will be cleared.), and the Basic Window to be changed will be displayed in the current screen. When the component in Basic Window calls the pop-up windows, the Basic Window is always on opening status, and the original information will be reserved, and the called pop-up window will be attached to the current Basic Window. The master-slave relationship is between Basic Window and all of related pop-up windows. When Basic Window N is switched to Basic Window M, all of the sub-windows of Basic Window N will be closed while Basic Window M and its sub-windows will be displayed.
Fast Selection Window	This window is the window called by the operation buttons, is generally used to place the commonly used buttons. And it will be always displayed in the screen until the operation button makes it hidden. The default Fast Selection Window is Frame 2. You can modify the other window as Fast Selection Window in [HMI Attribute]-[HMI Extended Attributes]-[Fast Selection Window].
Common Window	The components in this window will be displayed in the other window, but does not include Pop-up Window. Usually each window shared or the same components will be put in Common Window. The default Common Window is Frame 1. You can modify the other window as Common Window in [HMI Attribute]-[HMI Extended Attributes]-[Public Window].
Bottom Window	This window is generally used to put some common components such as background graphics, charts, and titles and so on. Using this window, you needn't to edit the some components repeatedly. The components in Bottom Window will be inserted into the general window during, and in fact window isn't displayed at all.
Pop-up Window	All the Pop-up windows are attached to the current Basic Window. The windows closed by the function key only can close Pop-up window, direct window or indirect window, can't close Basic Window. The direct window, indirect window, [Event Information Logon]-[Pop-up window] and [Function

Key]-[Popup window] all belong to the Pop-up window.

One screen can include Basic Window, Fast Selection Window, Common Window, while every Basic Window or Common Window can include many Bottom Windows and Pop-up Windows. The relationship between them is shown as below:

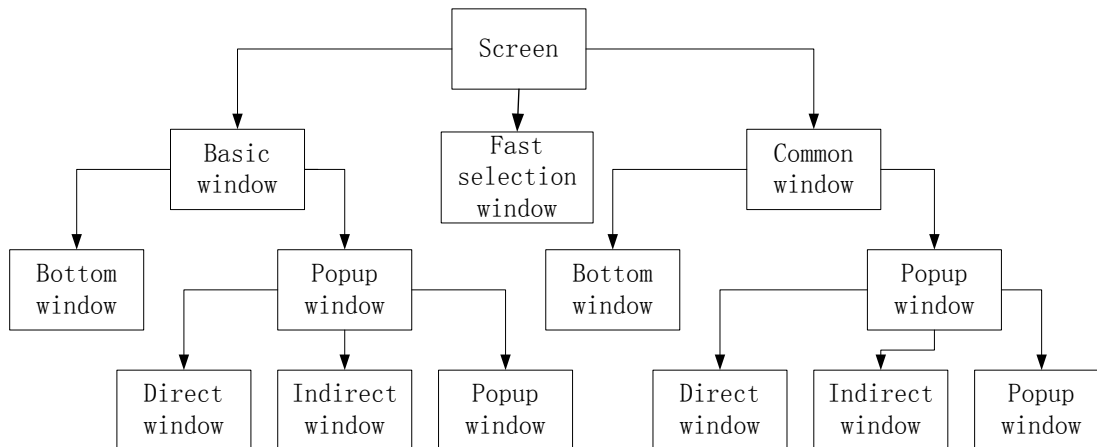

※ The pop windows by Event information logon and Function key setup

The number of windows in each project is limited as follows :

Window Type	Default Window No.	The largest number of windows
Basic Window	0	The window No. ranges: basic window 0, 10 to 32767
Common Window	1	1
Fast Selection Window	2	1
Bottom Window	--	Up to 3 bottom windows can be set for each window.
Pop-up Window	--	Unlimited until the memory runs out



1.As once opened , the popup window won't release the RAM unless closed, it is suggest to use it as few as possible.

2. The same window can be opened once by one related window, therefore you can't open the same window by 2 or up direct window/ indirect window in the basic window.

3. All the Pop-up windows are attached to the current basic window, so when the current window is switched to the other Basic Window, the Pop-up window will be closed. In this case, if the window is switched back to this Basic Window, you will find that the Pop-up window originally attached to this window still exist; otherwise you use the [Close window] function of function key.

4.A popup window in the common window does exist until shut down with the Function key [Close window]

5. Fast Selection Window supports the Pop-up window.

6. Use Basic window rather than Popup window, Indirect window or direct window which may slow down the communication speed.

7. The actual largest number of Basic window and Popup window is related to HMI's RAM.

3.2 System Default Window

A new project has 10 default windows as seen in the Project structure window as follows:

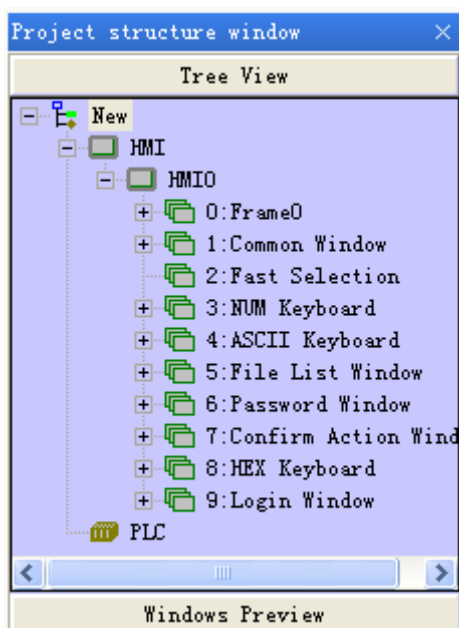

Default windows description:

Window number	Window name	Description
0	Frame0	Basic window, default initial window
1	Common Window	Common window, two popup windows used to pop default keyboard. Do not delete these two windows or the keyboard is unavailable. Attention: Devices used in every window can be put in it
2	Fast Selection	Fast Selection, used in coordinate with [Fast selection window] in HMI attribute
3	NUM Keyboard	NUM Keyboard, default keyboard
4	ASCII Keyboard	ASCII keyboard, backup
5	File List Window	File List Window, used in coordinate with [Input/Export] in Function key
6	Password Window	Password Window, used in coordinate with File List Window
7	Confirm Action Window	Confirm Action Window, pop up when [Control setting]-[Operator confirm] is chosen For details, refer to [Advanced Part 4.1.7 Control Setting Option]
8	HEX Keyboard	HEX Keyboard, backup
9	Login Window	Login Window, pop up when [Control setting]-[Conditional enable]-[Security level]-[auto show login window] is chosen More information refer to [Advanced Part 10 Password]



1. Default Frame 0~9 no deletion
2. Device address and attribute in Frame1-9 cannot be modified, or they may not be in normal use. You can only change the text set

3.3 Edit Window

3.3.1 Window Add

A new project has 10 system default windows. User can add some new windows, and there are 3 methods to create a new window.

- Click the [Add Frame] in [Screen] menu.

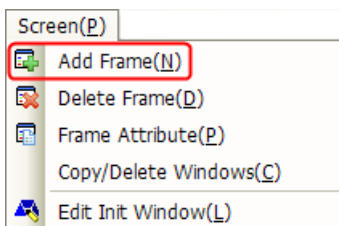

- Click the  icon of [Add Window] in [Page Switch Toolbar].
- Select the HMI0 to right click in Project Structure Window and select [Add Frame],

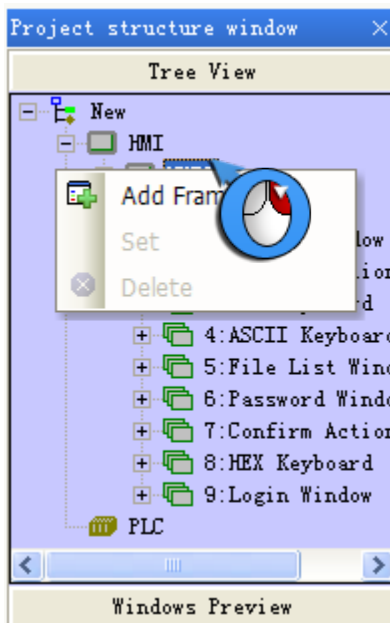

Click [Add Frame], and the [New Frame] dialog box will pop up.

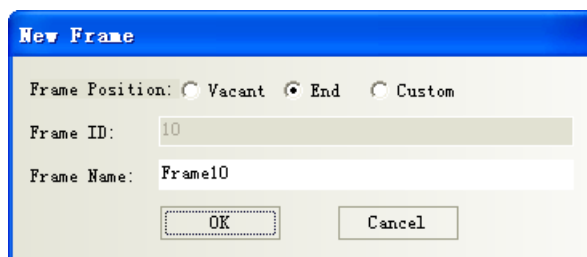

Specific descriptions are shown as below:

Name		Descriptions
Frame Position	Vacant	When the existing windows are not in a continuous order, the new window will automatically insert in the first vacant place.
	End	The new frame will automatically be numbered next to the existing last number. Default choice.
	Custom	The new frame number can be defined freely from 10 to 32767 without duplicating the existing number.
Frame ID		New frame number. When the Frame position is [Vacant] or [End], this option is unavailable. Only when it is [Custom], you can modify it.
Frame Name		Either default or custom



After [New Frame] setting, click **[New]**, a new frame is created.

3.3.2 Window Opening

There are 4 methods to open the window after the window is created.

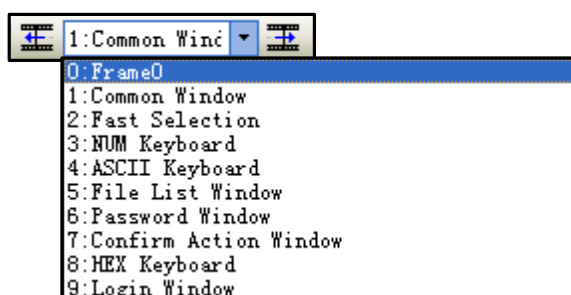
- Select the window in the pull-down menu in [Page Switch Toolbar].



- Click the icon of [Previous page]/[Next page] to open the window. The previous window can be displayed by clicking the  icon, and the next window can be displayed by clicking the  icon.
- Click the window ID in [Project Structure window]-[Tree View].

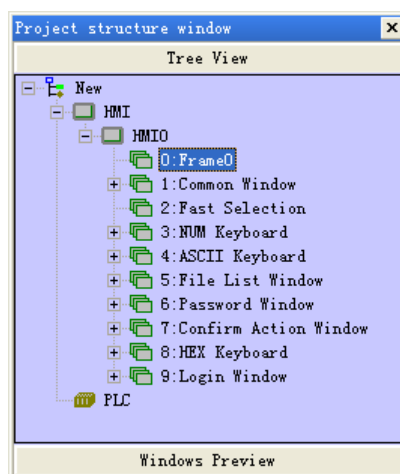

- Double-click the window ID in [Project Structure window]-[Windows Preview].

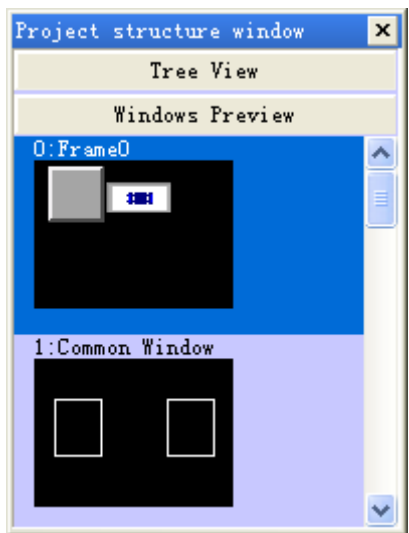

3.3.3 Window Copy/ Multi-Windows Copy

- Window support the function of copy and multi copy. Click the [Copy/Delete windows] in [Screen] menu to copy window.

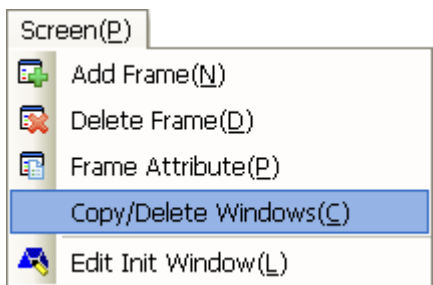

Click [Copy/Delete windows] and the following dialog box will pop up:

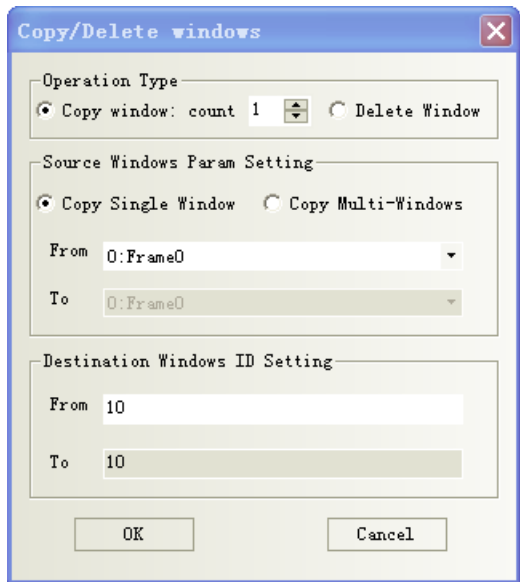

Specific descriptions are shown as below:

Name		Descriptions
Operation Type	Copy window: count	Select the function of Copy window and set the count
Source Windows	Copy Single Window	Set the starting source copied window ID

Param Setting	Copy Multi-Windows	Set the starting source copied window ID and the end source window ID, from window M to window N will be copied at the same time.
Destination windows ID Setting		Set the starting destination windows ID. The end destination window ID will increase automatically according to the copied number and the number of the source window, can't be modified.



The destination window ID mustn't be the existing window ID.

3.3.4 Window Deletion/ Multi-Windows Deletion

- Delete the current window

There are 4 methods to delete the current window:

- Click [Delete Frame] in [Screen] menu.

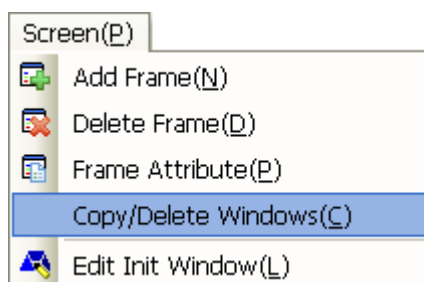

- Click the  icon of Delete Frame in [Page Switch Toolbar]
- Right click the selected window in [Project Structure window]-[Tree View], select [Delete].

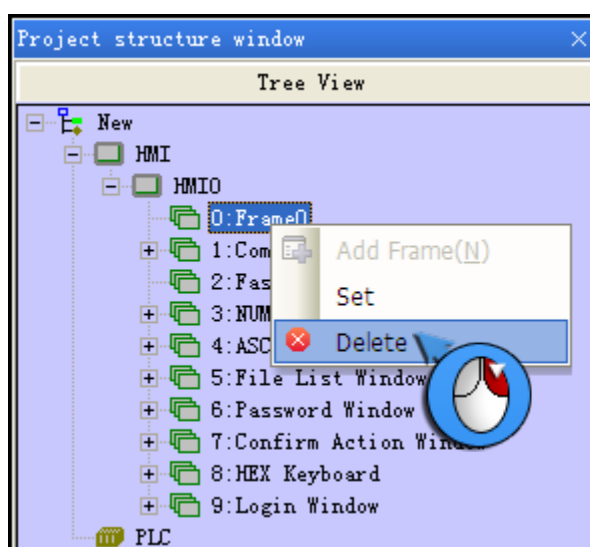

- Selected the window in [Project Structure window]-[Tree View], and press the [Delete] key of PC keyboard.
- Delete custom window
 - Click the [Copy/Delete windows] in [Screen] menu to delete window.

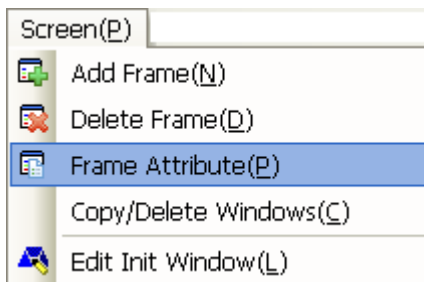

➤ Click [Copy/Delete windows] to pop up the [Copy/Delete windows] properties dialog box, and select [Delete Window].

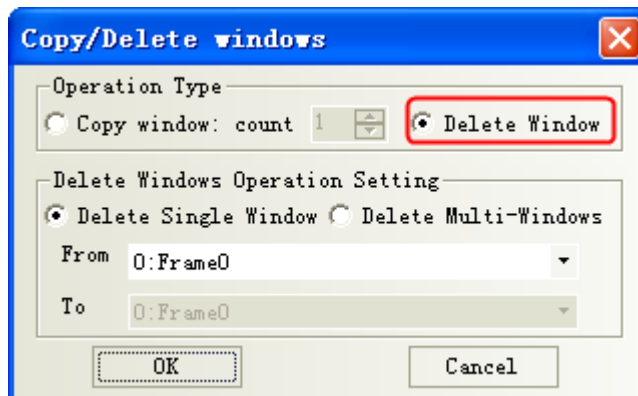

Specific descriptions are shown as below:

Name		Descriptions
Operation Type	Delete Window	Select the function of delete window.
Delete Window	Delete Single Window	Set the starting deleted window ID
	Delete Multi-Windows	Set the starting source deleted window ID and the end source window ID, from window M to window N will be deleted at the same time.



1. After delete window, all components in this window will lost and can't be recovered. Be careful with using this function.
2. The windows from Window 0 to window 9 are system default window, unable to delete.

3.4 Window Attribute

3.4.1 Open Window Attribute Box

There are 5 methods to change the window attribute in Kinco HMIware software.

- Click [Frame Attribute] in [Screen] menu.

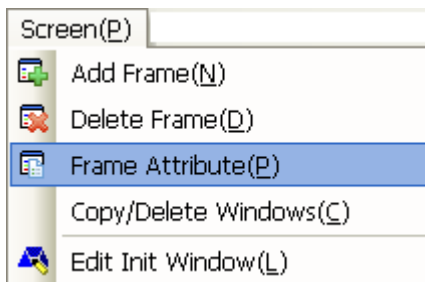

- Click the icon in the [Current Frame Attribute] in [Page Switch Toolbar].
- Directly click the icon.
- Double-click the blank in the current window.
- Right click the selected window to set in [Project structure window]-[Tree View], select [set].

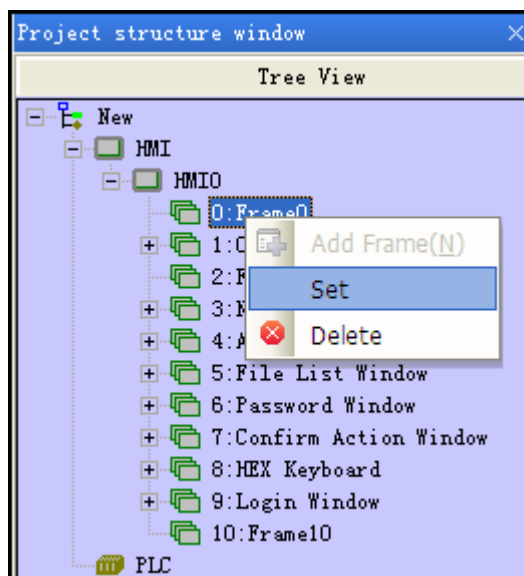

3.4.2 Window Attribute Descriptions

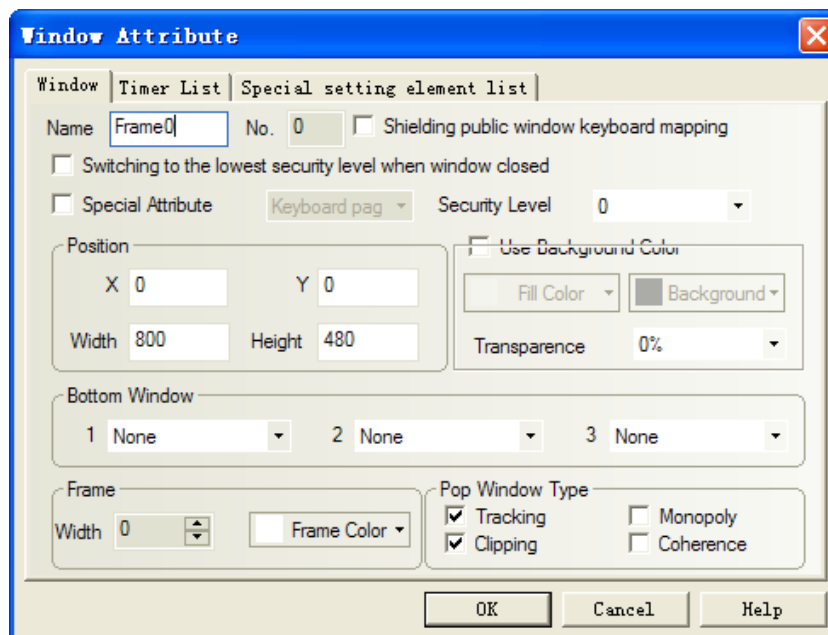

Window attribute descriptions are shown as below:

Window attribute descriptions	
Name	Assign the name for each window for convenient differentiation.
No.	The window No. ranges from 0 to 32767. Window No. can be set when the new window is created, and it can't be changed after it has been created.
Security Level	Set the security level for the current window For details, refer to [Advanced Part 10 Password]
Switching to the lowest security level when window closed	This function is used with security level. For details, refer to [Advanced Part 10 Password]
Position	X/Y This function is only valid for using “popup window” function of the function key. When the window is set this attribute, the vertex in the upper-left of the window will be displayed in the special X/Y position.
	Width/Height Set the width and height of the window. If the special attribute features [Print page], the width and height both can be larger than the fact screen size, but do not exceed 1024. For details, refer to [Advanced Part 13 Print]
Bottom Window	Set the corresponding bottom windows for the current window. The bottom window is in the bottom of the edit window as background graphics. The window to be set as the bottom window must be the created window, where the components used by the multiple windows together can be put.
Frame	Set the width and the color of frame. The frame width ranges from 0 to 16. If the width is not 0, the color can be selected for the frame.
Shielding public window keyboard mapping	If the shielding public window keyboard mapping is selected, it will shield the keyboard in the common window. This function is only valid for the self-keyboard HMI.
Special Attribute	Keyboard page: Set the current window as keyboard window, and use with the specified keyboard of the keyboard setting in component attribute. For details, refer to [Advanced Part 2.4 Keyboard] Print page: Set the current window as print window. For details, refer to [Advanced Part 13 Print] Video page: Set the current window as video window. It is set when video component is put in pop-up window.
Use Background Color	[Fill color] is the background color, [Background] is the filling graphics color. If the fill

	style is 0, only fill color is displayed in this window.								
Transparence	It is only valid for the pop-up window and the fast selection window. Transparence is 0%, 20%, 50%, 80%, 100%								
Pop Window Type	The Pop Window Type shows the relationship between one pop-up window and its adjacent window.								
	<table border="1"> <tr> <td>Monopoly</td> <td>If one window features “Monopoly” , its parent window will be frozen after it pops up, and it will always be displayed in the Top layer.</td> </tr> <tr> <td>Clipping</td> <td>If one window features “Clipping” , the border of this window will be restricted by its parent window, i.e. the part displayed out of the border of its parent window will be cut off.</td> </tr> <tr> <td>Tracking</td> <td>If one window features “Tracking” , it will move together when its parent window moves.</td> </tr> <tr> <td>Coherence</td> <td>Window A and Window B are both attached to the Basic Window. Generally, Window A will be displayed in the Top layer when it is touched. But if “Coherence” is selected, it will not be displayed in the Top layer even if it is touched, but it will always be attached to its parent window. For details, refer to [Advanced Part 3 Window]</td> </tr> </table>	Monopoly	If one window features “Monopoly” , its parent window will be frozen after it pops up, and it will always be displayed in the Top layer.	Clipping	If one window features “Clipping” , the border of this window will be restricted by its parent window, i.e. the part displayed out of the border of its parent window will be cut off.	Tracking	If one window features “Tracking” , it will move together when its parent window moves.	Coherence	Window A and Window B are both attached to the Basic Window. Generally, Window A will be displayed in the Top layer when it is touched. But if “Coherence” is selected, it will not be displayed in the Top layer even if it is touched, but it will always be attached to its parent window. For details, refer to [Advanced Part 3 Window]
	Monopoly	If one window features “Monopoly” , its parent window will be frozen after it pops up, and it will always be displayed in the Top layer.							
	Clipping	If one window features “Clipping” , the border of this window will be restricted by its parent window, i.e. the part displayed out of the border of its parent window will be cut off.							
	Tracking	If one window features “Tracking” , it will move together when its parent window moves.							
Coherence	Window A and Window B are both attached to the Basic Window. Generally, Window A will be displayed in the Top layer when it is touched. But if “Coherence” is selected, it will not be displayed in the Top layer even if it is touched, but it will always be attached to its parent window. For details, refer to [Advanced Part 3 Window]								
Note: If “Clipping” is selected, “Tracking” must be selected simultaneously.									

Timer List descriptions

Timer List	Show all the timers. If there is none , it won` t display.
------------	--

Special setting element list descriptions

Special setting element list	Show all the timers and setting components with window attribute. If there is none ,it won` t display
------------------------------	---

【Example】 Pop Frame10,11,12 over Frame0,transparence are respectively0%,20%,80%.Moreover,initial coordinate are respectively (0,0) , (110,0) , (220,0) .

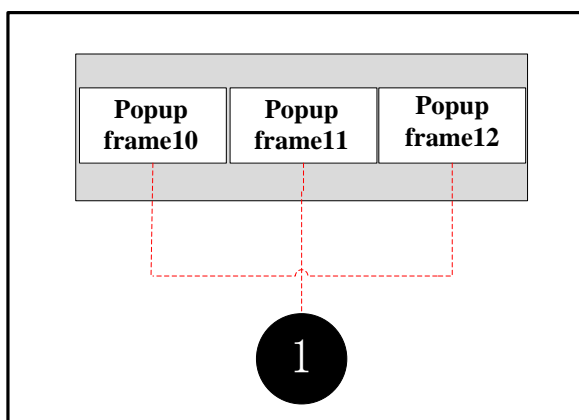

❶ frame0:3 function keys to pop frame10,11,12:

function	Change window: pop frame10	pop frame10	pop frame10
Tag	Use tag; 0: Pop frame10	Use tag; 0: Pop frame11	Use tag; 0: Pop frame12
Graphic	<p style="text-align: center;">State0 State1</p> <p style="text-align: center;">  </p> <p>Vector graphic:</p>		

❷ Frame10, 11, 12 attribute settings:

Initial coordinate	0	110	220
transparence	0%	20%	80%
Background color	choose, fill color: yellow		

❸ Save, compile and download. In operation, click function key, you can see frame as bellow

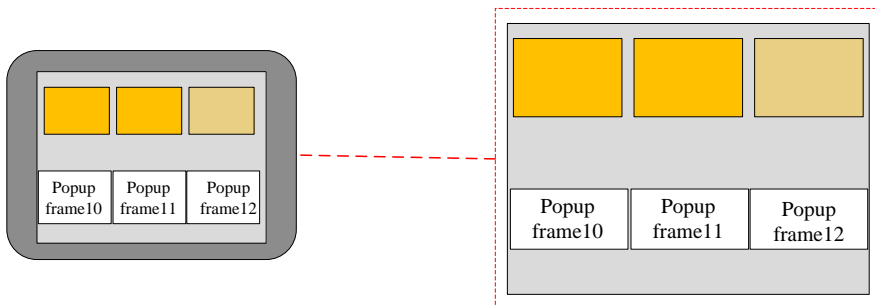

3.5 Components Related to Window

Components directly related to the window are: Direct window, indirect window, and function key (Change window, Goto Prev, Change common window, Change fast selection window, Popup window, Close window, Popup window title bar and Minimize).

Functions directly related to the window are: Change Window, Write Data to PLC (Current Base Window), Change Window (Ignore the window 0) of PLC Control.

[👉 For details about contents of these components, refer to \[Advanced part 4 Component\]](#)

4 Component

Components are the objects by which user inputs and operate data; user can execute some operations by operating these objects. The attribute of component must be set correctly according to actual application. Different attributes influence the component operating and executing result directly. This chapter will introduce the detail of component attribute.

4.1 Common Setting of Component

4.1.1 Create and Delete Component

(1) Create component

There are two ways to create component:

- Create from the Graph element window

In the PLC parts/Function parts/projects database of Graph element window, drag the component to the edit area, then the attribute window will pop up automatically, there will be a “+” cursor when you click the OK of attribute window, then move the cursor to appropriate position and click left button to put the component, click right button to cancel creating component. As shown in following picture:

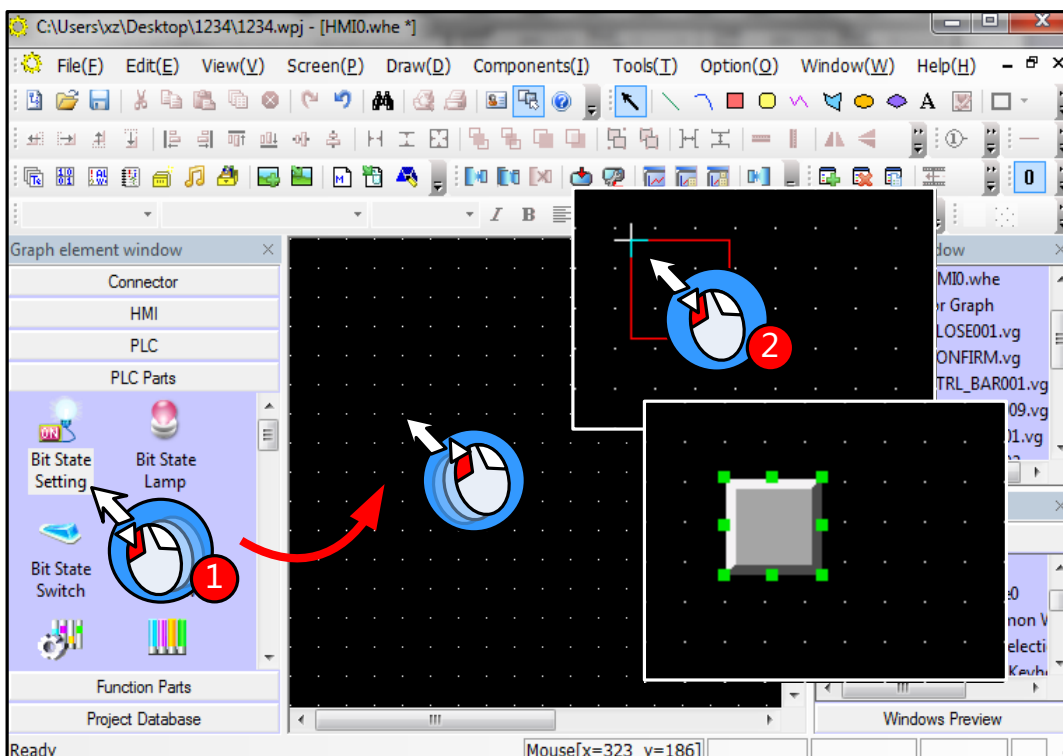

- Create from Menu

Click the components(I) menu, chose a wanted component, then the attribute window will pop up automatically, there will be a “+” cursor when you click the OK of attribute window, then move the cursor to appropriate position and click left button to put the component, click right button to cancel creating component.

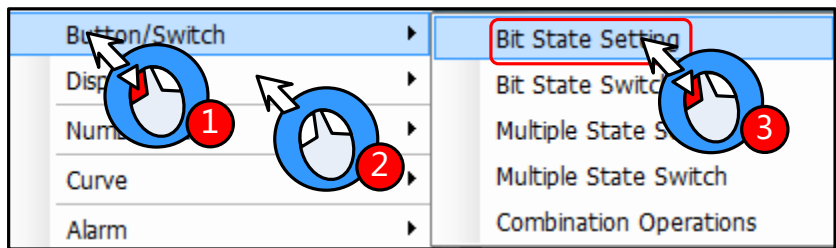

Text library, address tag and sound lib are in the **Option(O)** menu

(2) Delete component

There are two ways to delete the components that have created

- Delete by right click menu

Chose the component, right click then click the Delete to delete the selected component

- Delete by Delete key on the key board

Chose the component, then press the Delete key on the keyboard to delete component

4.1.2 Execution Order of Components

In some application, there is a chance that one touch to trigger multiple components execution, so the customer stacks several components together.

At this time, if there is a touch operation, the stacked components are not executed at the same time but executed according to the order of components.

The top component is executed first, then the following components. As shown in the following picture:

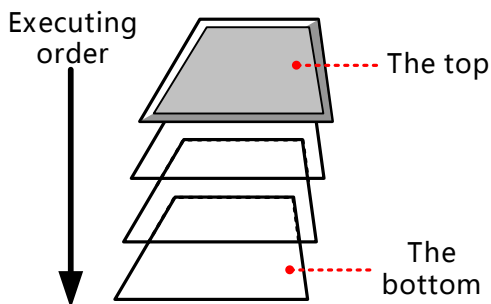

Besides, customer can check the layer position of the stacked components

Right click the stacked components; you can see the following options:

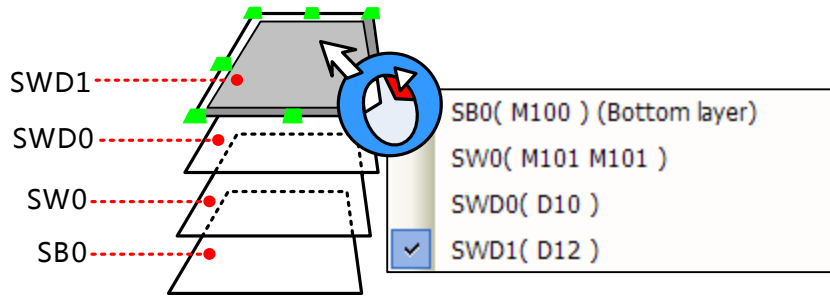

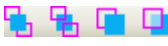
You can use the tool bar  (set top/set bottom/ previous layer/next layer) to adjust the layer position of the stacked components

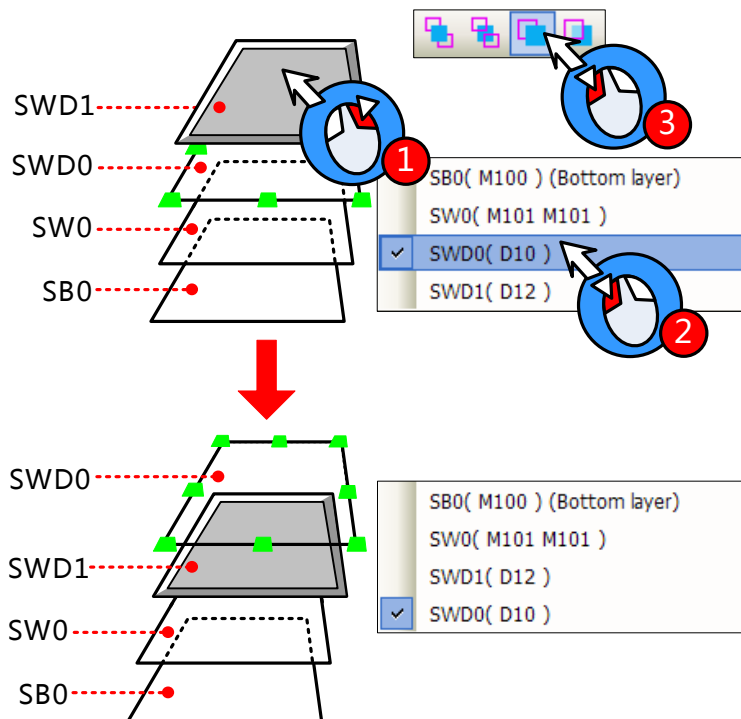

1. If there is a component that executes Change window operation in the stacked components, the components that under this Change window component will not be executed.

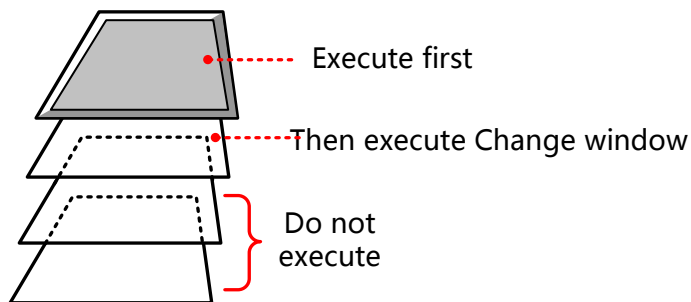

2. The number of stacked components should be less than 32.

4.1.3 Methods to Open Attributes Window

The attributes window will pop up automatically when the component created, and there are three methods to open attribute

window of the created component.

- Double click to open attribute window
- Chose the component, right click, chose the Attribute operation in the menu
- Chose the component, click the  icon on the tool bar

How to open attributes window of stacked components

When multiple components stacked together, the lower component can be selected by right click, then open attributes window by above methods.

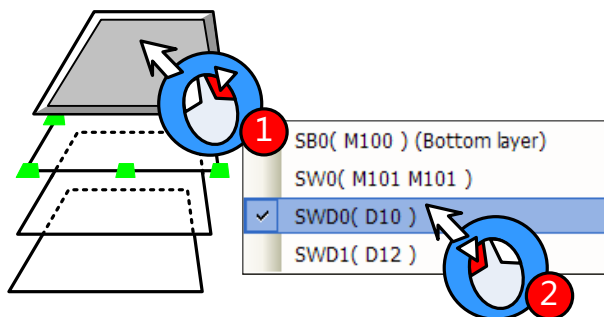

Multiple attribute windows can not be open at the same time

4.1.4 Basic Setting

In the **Basic Attributes** option, customer can set the operation object, address type and other related attributes

Basic Attributes

Detail description of **Basic Attributes**

Priority Normal	
<input type="checkbox"/> Read Address Same As Write Address	
Read Address	
HMI HMIO	PLC No.
Port None	
<input type="checkbox"/> Change Station Num 0	
Addr. Type LB	
Address 0 <input type="checkbox"/> System Register	
Code Type BIN Word Length 1	
Format(Range):DDDD (0-9999)	
<input type="checkbox"/> Use Address Tag	
<input type="checkbox"/> Use the index register	
Description 	
Write Address	
HMI HMIO	PLC No.
Port None	
<input type="checkbox"/> Change Station Num 0	
Addr. Type LB	
Address 0 <input type="checkbox"/> System Register	
Code Type BIN Word Length 1	
Format(Range):DDDD (0-9999)	
<input type="checkbox"/> Use Address Tag	
<input type="checkbox"/> Use the index register	

Priority	Reserved
----------	----------

Write Address	The register address to which the status value or data that writes. If it is unavailable, the component is read-only component, the display status depends on the value and data in the Read Address	
	HMI	The HMI number; the number is distributed automatically in order when the HMI is built
	PLC No.	The PLC controller number; the number is distributed automatically in order when the PLC controller is built
	Change Station Num	When HMI communicate with multiple PLC controllers, you can use this option to connect corresponding PLC controller. This option is used in the application that uses one HMI-multiple PLCs or ,multiple HMIs-multiple PLCs but only one PLC in the program ☞ For details, refer to [Advanced Part 2.11.2 Index Station Num]
	Addr. Type	Chose the address type of the PLC register or HMI local register Bit registers in HMI : LB、LW.B、RB、RBI、FRB、FRBI Word registers in HMI: LW、RW、RWI、ERW0~2、ERWI0~2、FRW、FRWI ☞ For details, refer to [Advanced Part 15.1 Local Register of HMI] PLC/Controllers' address type is different according to different PLC/controller device ☐ Refer to the Communication Connection Guide for more details about PLC/controller address type
	Address	Set the register address of the command or data
	Code Type	BIN, BCD or LSB ☞ For details, refer to [Advanced Part 2.5 Cdoe Type]
	Word Length	The register number that the component takes up, It is usually 1, it also changes according to different components and address type.
	System Register	The registers in HMI which have special use ☞ For details, refer to [Advanced Part 15.2 System Special Registers of HMI]
	Format	The format of the address type in PLC/controller or HMI
	Use Address Tag	Use the addresses that have been defined in the Address Tag ☞ For details, refer to [Advanced Part 5.2 Address Tag Library]
Use the index register	Use a certain register as the index register of the component ☞ For details, refer to [Advanced Part 2.11.1 Index Register]	
Read Address	The register address from which the status value or data read. If it is unavailable, the component is	

	write-only component; the display status cannot display the data or state of read address.
Description	The reference name of this component.



4.1.5 Tag Setting

In the Tag option of component attribute, set the display text of each state.

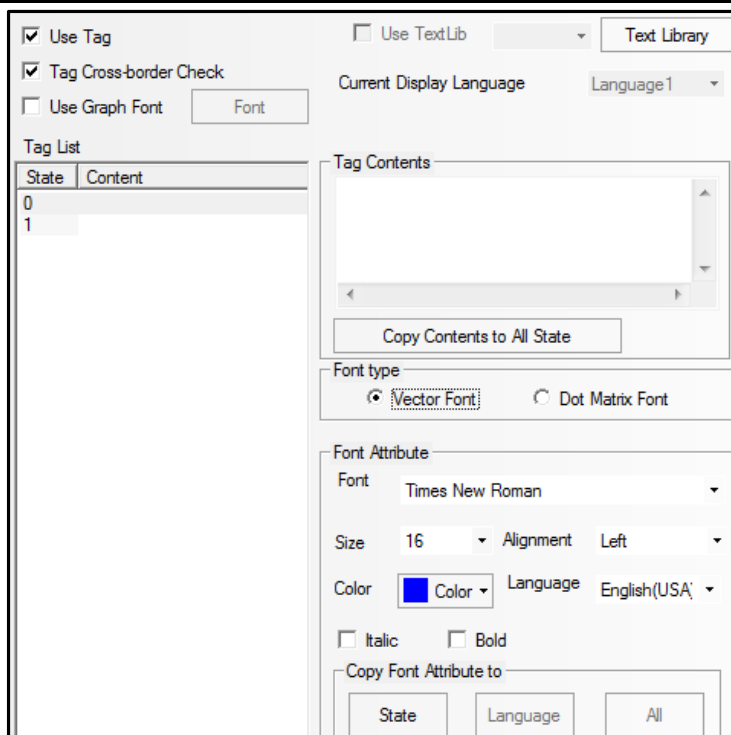

Detail description of Tag

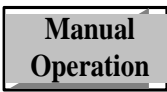

Use Tag	Use the tag	
Use Graph Font	Use graph font mode in tag text For details, refer to [Advanced Part 2.3.4 Graph Font]	
Tag Cross-border Check	Checked	Adjust the component size automatically according to the tag content, as following picture: 
	Uncheck	Do not adjust the component size automatically according to the tag content, the tag content that cross border will be cut, as following picture: 

Use Textlib	Use the text in the textlib as tag content For details, refer to [Advanced Part 5.1 Text Library]
Tag List	The comment text corresponding to each state
Tag Content	Input the comment text of each state here
Copy Contents to All State	Chose one state in the Tag list, click this option to copy the tag content of this state to all the state
Front Type	Use vector font or dot matrix font in tag content For details, refer to [Advanced Part 2.3 Text]
Font Attribute	Set the attributes of the tag content, like font, size, alignment, color and so on. The current font attributes can be copied to each state or tag content of each language

- The steps to set tag:

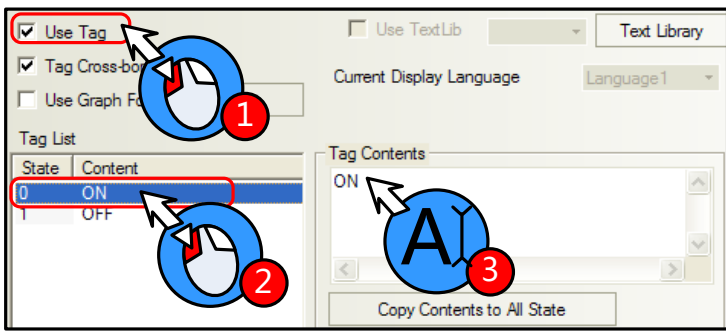
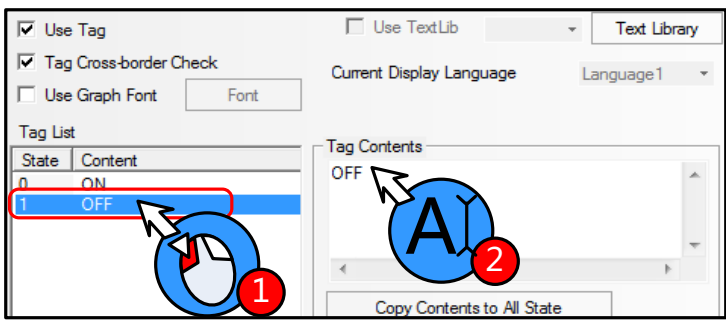
Add tag content of state 0	Step
	<ol style="list-style-type: none"> 1 Check the “Use Tag 2 Chose the state 0 in Tag List 3 Input comment text in the Tag Content
Add tag content of state 1	
	<ol style="list-style-type: none"> 1 Chose the state 1 in Tag List 2 Input comment text in the Tag Content

4.1.6 Graphics Setting

Set the graphic of each state in the Graphics option of component attribute, the graphic can be vector or bit map.



Detail description of **Graphics**

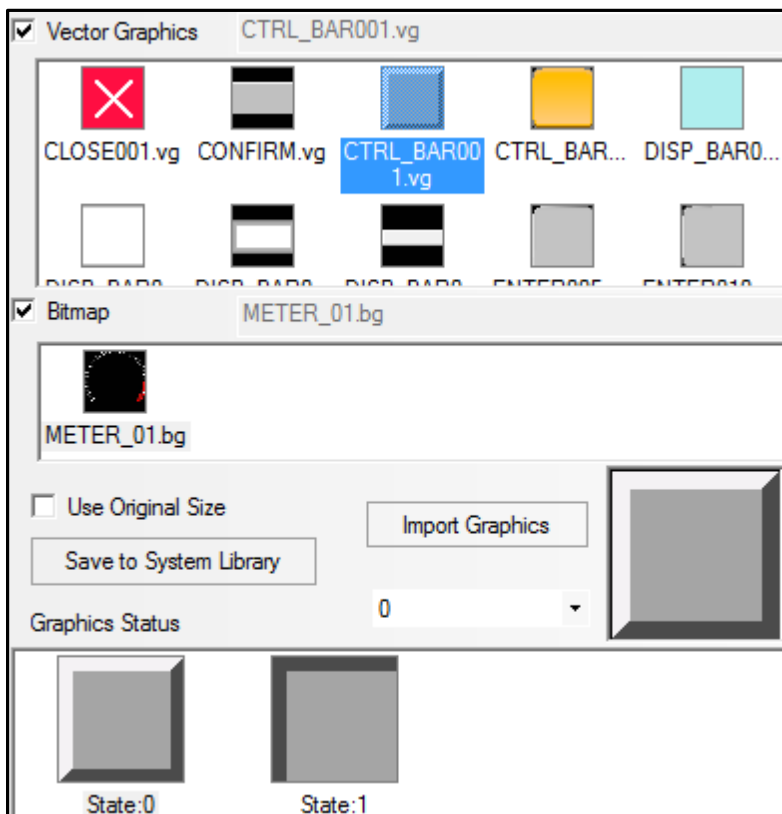

Vector Graphics	Use vector graphic to display	Bitmap	Use bitmap to display
Use original size	This option is effective when chose bitmap as graphic, if it is checked, component will display the original size of the graphic		
Save to System Library	Save the checked graphic or graphic of some state to the system library in the UserselPath file folder		
Import Graphics	Import vg or bg format graphic from system library or external		
Graphics Status	Preview the graphic of the checked state. For some stateless control component, like Vector Graph and Bitmap, The graphic display in Vector or Bitmap is the picture checked here. Refer to Advanced Part 5.3 Graphic Library for more details		

4.1.7 Control Setting Option

Set the control conditions and security in the Control Setting, also can set the trigger macro and trigger register operation here.



Detail description of Control Setting

<p>Touching Enabled Setting</p> <p><input type="radio"/> Always Valid <input type="checkbox"/> Show Elements Invalid Tag</p> <p><input type="radio"/> Always Invalid <input type="checkbox"/> Auto show login window</p> <p><input checked="" type="radio"/> Conditional Enabling</p> <p><input checked="" type="checkbox"/> Security Level Minimum level: 0</p> <p><input checked="" type="checkbox"/> Permission Control Select Permission: 0:</p> <p><input checked="" type="checkbox"/> Register Control</p> <p><input checked="" type="radio"/> Bit Control <input type="radio"/> On <input checked="" type="radio"/> Off</p> <p><input type="radio"/> Word Control</p> <p>Control Register</p> <p>HMI: HMI0 PLC No.: []</p> <p>Port: None <input type="checkbox"/> Use Address Tag</p> <p><input type="checkbox"/> Change Station Num: 0</p> <p>Address Type: LB Addr.: 0</p> <p>Code Type: BIN Word Length: 1</p> <p>Format(Range): DDDD (0-9999)</p> <p><input type="checkbox"/> Use the index register</p>	<p>Security Setting</p> <p>Min Press Time(X100ms): 0</p> <p><input checked="" type="checkbox"/> Operator Confirm wait(s): 30</p> <p><input checked="" type="checkbox"/> Records Operations SB</p> <p>Min Time Interval (seconds): 0</p> <p>Notifications</p> <p><input checked="" type="checkbox"/> Trigger Macro macro_0.c</p> <p><input checked="" type="checkbox"/> Trigger Register <input checked="" type="radio"/> Bit <input type="radio"/> Word</p> <p><input checked="" type="radio"/> Written Notice</p> <p><input type="radio"/> After Written Notice</p> <p>Write Value: <input checked="" type="radio"/> On <input type="radio"/> Off</p> <p>Notice Register</p> <p>HMI: HMI0 PLC No.: []</p> <p>Port: None <input type="checkbox"/> Use Address Tag</p> <p><input type="checkbox"/> Change Station Num: 0</p> <p>Address Type: LB Addr.: 0</p> <p>Code Type: BIN Word Length: 1</p> <p>Format(Range): DDDD (0-9999)</p> <p><input type="checkbox"/> Use the index register</p>
--	--

Touching Enable Setting	Always valid	The touch is enabled always the time. The operator can operate is all the time
	Always invalid	The touch is never enabled. The operator cannot control operator it
	Conditional Enabling	<p>Security Level: If clicked means the current security level must higher than the set security, so the operator can operate this component to set the state value or data to the corresponding register.</p> <p style="text-align: center;">Controlled by security level 3 Controlled by no security level Input level 3 password</p> <p>For details, refer to [Advanced Part 10.3.1 Security Level Protection for Components]</p>
Permission Control	Permission Control: If clicked means the operator must has corresponding permission so he can operate this component to set the state value or data to the corresponding register.	

		<p>User access list</p> <table border="1"> <thead> <tr> <th>Name</th> <th>Access1</th> <th>Access2</th> <th>Access3</th> </tr> </thead> <tbody> <tr> <td>User1</td> <td>○</td> <td>×</td> <td>×</td> </tr> <tr> <td>User2</td> <td>○</td> <td>○</td> <td>○</td> </tr> </tbody> </table> <p>Controlled by access 2 Controlled by access 1</p> <p>For details, refer to [Advanced Part 10.3.2 User Permission Protection for Components]</p> <p>Register Control: if clicked means the specified bit register or word register must satisfy the setting conditions, so that operator can operate this component to set the state value or data to the corresponding register.</p> <p>Operate condition</p> <table border="1"> <thead> <tr> <th>ON</th> <th>OFF</th> </tr> </thead> <tbody> <tr> <td>○</td> <td>×</td> </tr> </tbody> </table> <p>Controlled by register state Controlled by no condition</p> <table border="1"> <tr> <td data-bbox="523 1361 710 1563">Auto show login window</td> <td data-bbox="710 1361 1404 1563">If clicked means when touch the component but the current user security level or permission cannot satisfy the setting security level or permission, the password input window (Frame9: Login window) will pop up automatically.</td> </tr> </table>	Name	Access1	Access2	Access3	User1	○	×	×	User2	○	○	○	ON	OFF	○	×	Auto show login window	If clicked means when touch the component but the current user security level or permission cannot satisfy the setting security level or permission, the password input window (Frame9: Login window) will pop up automatically.
Name	Access1	Access2	Access3																	
User1	○	×	×																	
User2	○	○	○																	
ON	OFF																			
○	×																			
Auto show login window	If clicked means when touch the component but the current user security level or permission cannot satisfy the setting security level or permission, the password input window (Frame9: Login window) will pop up automatically.																			
	Show Element Invalid Tag	If clicked means when the component is touch invalid, the component will display touch invalid tag. This function is optional only when the Always Invalid or Conditional Enabling is selected. The color of touch invalid tag can be set in HMI Extended Attributes of HMI Attributes																		
Security Setting	Min Press Time	The minimum time of a hold pressing to make touch effective. The unit is 100ms, when it is set to 0, it means do not set this option.																		
	Operator Confirm	If clicked means when touch the component, the Confirm Window (Frame7: Confirm Action Window) will pop up. Click YES to make this touch effective and if click Cancel or do not click YES during the wait(s), the touch operation will be canceled																		

		automatically.		
	Record Operations	If clicked means the operation event will be recorded , this event can be displayed in the Operation Log , and saved in csv file in the external storage		
	Min Time Interval(Second)	The minimum time interval between two touch operations of one same component or two different components. 0 means do not set the Min time Interval		
Notification	Trigger Macro	Execute the specified macro when the operation to the component is successful		
	Trigger Register	Word	Written Notice	Write the “Write Value” to the specified register before the operation is executed successfully
			After Written Notice	Write the “Write Value” to the specified register after the operation is executed successfully
	Bit	Written Notice	Write the On/Off signal to the specified register before the operation is executed successfully	
After Written Notice		Write the On/Off signal to the specified register after the operation is executed successfully		

4.1.8 Display Setting

Set the display condition, display size, position in the Display Setting.

Display Setting

Detail description of Display Setting

Position

Lock

X: 132 Width: 50

Y: 74 Height: 50

Display Control (Touching is invalid when Components do not display)

Always Display

Never Display(Touching is invalid)

Conditional Display

Security Level Control Minimum Level: 0

User Permission Control Select Permission: 0:

Register Control

Bit Control On Off

Word Control

Control Register

HMI: HM10 PLC No.:

Port: None Change Station Num: 0

Addr. Type: LB Addr.: 0

Code Type: BIN Use Address Tag

Word Length: 1 Format(Range): DDDD (0-9999)

Use the index register

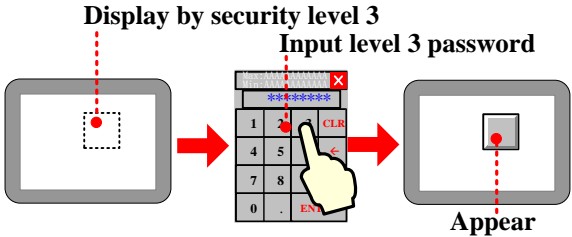
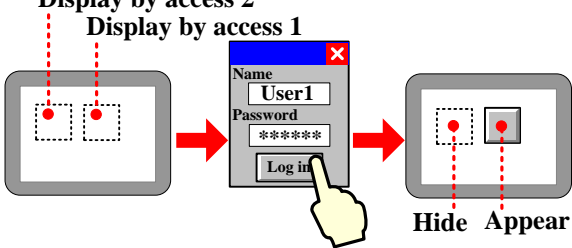
Lock	If clicked means the component is locked, the position of component cannot be changed by mouse or moving keys on keyboard												
X/Y	The coordinate value of the top left of component												
Width/Height	The width and height of component(The unit is pixel)												
Always Display	If clicked means the component is displayed all the time												
Never Display	If clicked means the component is hidden, the hidden component cannot touch												
Conditional Display	<p>Security Level Control: Clicked means the component is displayed only when the current security level is higher than the setting level.</p> <p style="text-align: center;">Display by security level 3 Input level 3 password</p>  <p style="text-align: center;">Appear</p> <p>For details, refer to [Advanced Part 10.3.1 Security Level Protection for Components]</p> <p>User Permission Control: If clicked means the component is displayed only when the operator has corresponding permission</p> <p style="text-align: center;">User access list</p> <table border="1" data-bbox="406 1097 718 1209"> <thead> <tr> <th>Name</th> <th>Access1</th> <th>Access2</th> <th>Access3</th> </tr> </thead> <tbody> <tr> <td>User1</td> <td style="text-align: center;">○</td> <td style="text-align: center;">×</td> <td style="text-align: center;">×</td> </tr> <tr> <td>User2</td> <td style="text-align: center;">○</td> <td style="text-align: center;">○</td> <td style="text-align: center;">○</td> </tr> </tbody> </table> <p style="text-align: center;">Display by access 2 Display by access 1</p>  <p style="text-align: center;">Hide Appear</p> <p>For details, refer to [Advanced Part 10.3.2 User Permission Protection for Components]</p> <p>Register Control: Click means he component is displayed only when the specified bit register or word register satisfies the condition</p>	Name	Access1	Access2	Access3	User1	○	×	×	User2	○	○	○
Name	Access1	Access2	Access3										
User1	○	×	×										
User2	○	○	○										

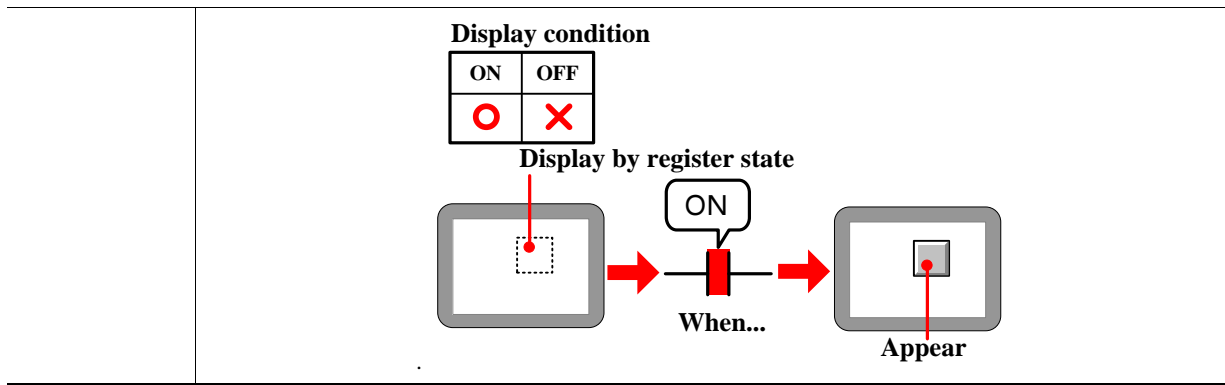

4.1.9 Touch Sound Control

In the **Sound** option, set the sound when the component is touched



Detail description of Sound

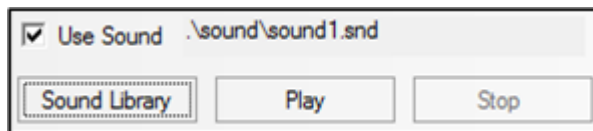

Use Sound	Set the sound when the component is touched.		
Sound Library	Open the sound library attributes box. For details, refer to [Advanced Part 4.15.6 Sound Lib]		
Play	Play and listen the audio	Stop	Stop the audio

[For details, refer to \[Advanced Part 5.4 Sound Lib Application\]](#)



“The sound function is only suitable for the HMI with audio output port.

4.1.10 Save Historical Data



Detail description of Save Historical Data

<input checked="" type="checkbox"/> Save to Recipe Data Field Start Addr. <input type="text" value="0"/> End Addr. <input type="text" value="69"/> Addr. Format DDDDDD <input type="checkbox"/> Save as CSV External Device: <input type="text" value="SD Card"/> Subdirectory: <input type="text" value="TrendToCSV"/> Trigger para HMI <input type="text" value="HMIO"/> PLC <input type="text" value="No."/> Addr. Type <input type="text" value="LB"/> Address <input type="text" value="0"/> Code Type <input type="text" value="BIN"/> Word Length <input type="text" value="1"/> <input type="checkbox"/> Use Address Tag Format(Range):DDDD (0-9999) Trigger Style <input type="text" value="OFF->ON"/> <input type="checkbox"/> Ascending Order	<input checked="" type="checkbox"/> Save to External Device Storage Devices <input type="text" value="SD Card"/> <input checked="" type="checkbox"/> Outage Keepin <input type="checkbox"/> Data Encryption <input checked="" type="checkbox"/> Export to CSV File <input type="checkbox"/> Save MS Subdirectory <input type="text" value="HistoryTrend"/> Storage Type <input type="text" value="Daily File"/> Bulk Storage <input type="text" value="Default"/> Max Storage <input type="text" value="0"/> Days Note: 1 There is no limit when the max storage is zero. 2.Subdirectory name must be unique <input type="checkbox"/> Variable Subdirectory HMI <input type="text" value="HMIO"/> PLC <input type="text" value=""/> Addr. Type <input type="text" value="LW"/> Address <input type="text" value="0"/> Code Type <input type="text" value="BIN"/> <input type="checkbox"/> Use Addr. Tag Word Length <input type="text" value="8"/> Format(Range):DDDDD (0-10255)
--	--

Save to Recipe Data Field	Save sampling data to the recipe register (RW) of HMI The end address = the start address + 20 +sampling page number*(4+ channel number). If the data exceeds the storage limit, the sampling data will cover the previous data	
Save to External Device	Storage Devices	SD card, USB DISK1*、 USB DISK2* are optional
	Outage keep in	If the HMI is powered off and restart, the information can be regained
	Export to csv File	Save the sampling data to external device in CSV file. This CSV file is saved in /trend/subdirectory/file name
	Data Encryption	Encrypt the sampling data For details, refer to [Advanced Part 2.15 Data Encryption]
	Save MS	Save the sampling time to ms level and record in CSV file
	Subdirectory	Set the subdirectory name of CSV file when it is saved in external device, customer can change this name The default subdirectory name of History Data is History Data, Trend Curve is History Trend, XY plot is XY-CHART
	Storage Type	Daily File

		Single File	Save the sampling data by items, and the name of CSV file is the Subdirectory
	Bulk Storage	Provide a buffer storage mode, Only when the data is up to the bulk storage setting, and then write the data to SD card or U disk. The “Default” means don’t use buffer storage mode, as soon as there is sampling data, write this data to SD card or U disk	
	Max Storage	Set the limit of the storage: if it is by Daily File, the unit is day, if it is by Single File, the unit is item. If chose the “Daily File”, the file name is as “yyyymmdd”, The Max Storage means the maximum csv file number under this routine, if csv file exceeds the max storage number; the previous files will be deleted. If chose the “Single File” in Storage Type, the CSV file named by the Subdirectory name, The Max Storage means the maximum items in this csv file, if the items is up to the limit, the data will not be saved	
Variable Subdirectory	The Subdirectory is read from specified registers, the maximum register number is 16		

※ If a HMI has two USB host, the number of U disk depends on the sequence they plug in HMI. That is to say the first U disk that plug in HMI is USB DISK1, and the second U disk that plug in HMI is USB DISK2. It does no matter with the slot position.



When the sampling data is saving to external storage device, the special system register should set OFF before removing the external storage device, or the data will be damaged or lost. They are LB9153 (SD card)、LB9154 (USB disk1)、LB9155 (USB disk2)

4.2 Button/Switch Components

They are Bit State Setting, Bit State Switch, Multiple State Setting, Multiple State Switch, Combination Operations, and Function Key and so on.

4.2.1 Bit State Setting

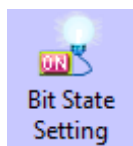

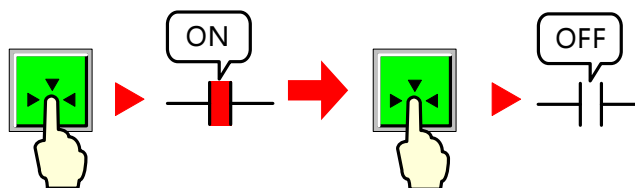

The Bit State Setting defines a touch area. When this area is active, this button can set the HMI bit address or PLC bit address On or Off. The display status of this component will not be changed by the input value.

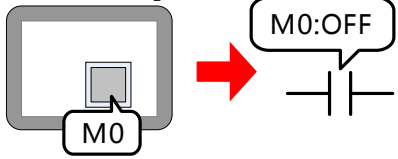
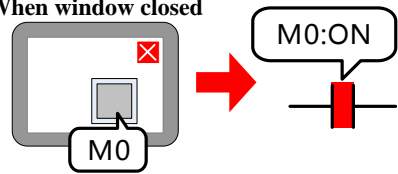
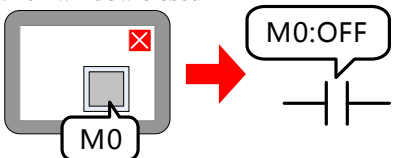
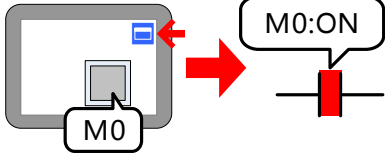
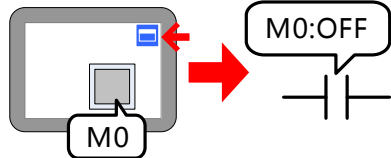
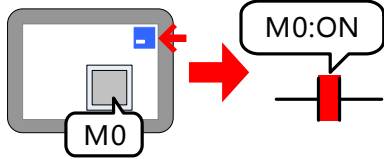

Bit State Setting

Detail description of Bit State Setting	
Type	Function description
On	<p>Press to set specified address ON, still ON if released or pressed again</p> <p>Press and ON → Press again still ON</p>
Off	<p>Press to set bit address OFF, still OFF if released or pressed again</p> <p>Press and OFF → Press again still OFF</p>
Toggle	<p>Press to set specified address ON, still ON if released; Press again to set address OFF, Still OFF if released</p> <p>Press and ON ↔ Press and OFF</p>
Reset	<p>Only when this component is hold pressing, the specified address is ON, change to OFF if released</p> <p>Press and ON → OFF when released</p>
Set On when Window Open	<p>When the window which contains this component opens, the specified address is set ON</p> <p>When window opened</p>
Set Off when Window Open	<p>When the window that contains this component opens, the specified address is set OFF</p>

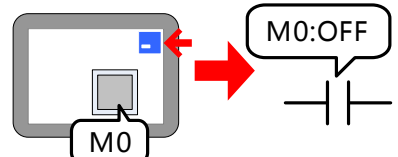
	<p>When window opened</p> 
<p>Set On when Window Close</p>	<p>When the window that contains this component closes, the specified address is set ON</p> <p>When window closed</p> 
<p>Set OFF when Window Close</p>	<p>When the window that contains this component closes, the specified address is set OFF</p> <p>When window closed</p> 
<p>Set ON when Window Maximized</p>	<p>When the window that contains this component is maximized, the specified address is set ON</p> <p>When window maximized</p> 
<p>Set OFF when Window Maximized</p>	<p>When the window that contains this component is maximized, the specified address is set OFF</p> <p>When window maximized</p> 
<p>Set ON when Window Minimized</p>	<p>When the window that contains this component is minimized, the specified address is set ON</p> <p>When window minimized</p> 
<p>Set OFF when Window Minimized</p>	<p>When the window that contains this component is minimized, the specified address is set OFF</p>

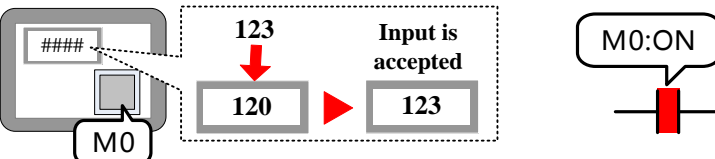
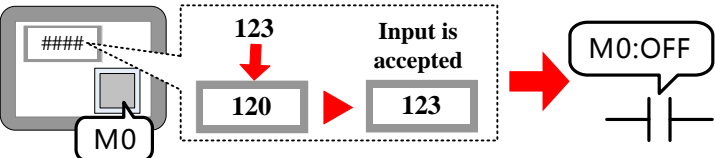
	<p>When window minimized</p> 
<p>Set On when Backlight Off</p>	<p>When the backlight of the window that contains this component is off, the specified address is set ON</p> <p>When backlight turned OFF</p> 
<p>Set On when Backlight Off</p>	<p>When the backlight of the window that contains this component is off, the specified address is set OFF</p> <p>When backlight turned OFF</p> 
<p>Set On when Input Success</p>	<p>In the window which contains this component, when a Number Input component inputs successfully, the specified address is set ON</p> 
<p>Set OFF when Input Success</p>	<p>In the window which contains this component, when a Number Input component inputs successfully, the specified address is set OFF</p> 
<p>Key</p>	<p>Map the component to the F1~F12 of external keyboard or F1~F8 of the HMI which has keys itself. This function is suitable for the HMI with USB host or HMI with keys itself</p>

4.2.2 Bit State Switch



The Bit State Switch is a combination of Bit State Lamp and Bit State Setting component, it defines a touch area, if this area is active, this component can switch HMI or PLC bit address between on and off, at

the same time, the display state of component will change according to the value of read address.

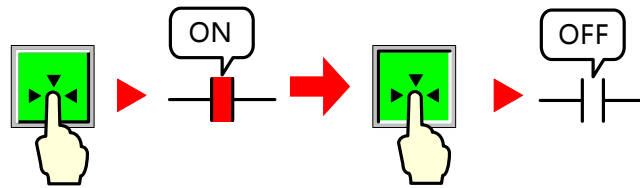

Bit State Switch

Detail description of Bit State Switch

Switch Type	Function description
On	<p>Press to set specified address ON, still ON if released or pressed again</p> <p>Press and ON Press again still ON</p>
Off	<p>Press to set specified address OFF, still OFF if released or pressed again</p> <p>Press and OFF Press again still OFF</p>
Toggle	<p>Press to set specified address ON, still ON if released; Press again to set address OFF, Still OFF if released</p> <p>Press and ON Press and OFF</p>
Reset	<p>Only when this component is hold pressing, the specified address is ON, change to OFF if released</p> <p>Press and ON OFF when released</p>
Key	<p>Map the component to the F1~F12 of external keyboard or F1~F8 of the HMI which has keys itself. This function is suitable for the HMI with USB host or HMI with keys itself</p>

4.2.3 Multiple State Setting

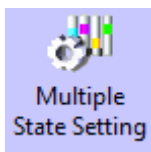

The Multiple State Setting component defines a touch area, if this area is active; this component writes a setting value to a specified register in HMI or PLC. The display status of component will not be changed by the value of read address.

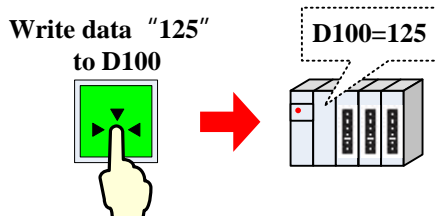

Multiple State Setting

Detail description of Multiple State Setting

Setting Mode	Set Constant	<p>Press component to set the setting constant to a specified register</p>
	Set at Window Open	<p>When the window with this component opens, set the setting constant to a specified register automatically</p>
	Set at Window Close	<p>When the window with this component closes, set the setting constant to a specified register automatically</p>
	Set at Window Maximized	<p>When the window with this component is maximized, set the setting constant to a specified register automatically</p>

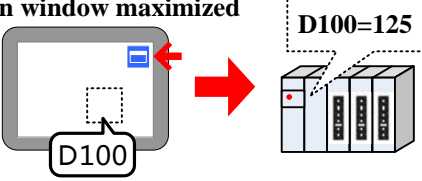
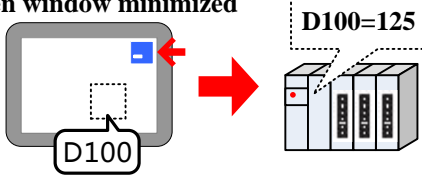
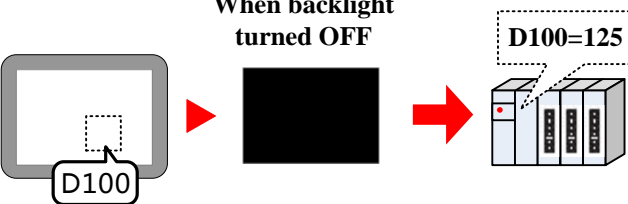
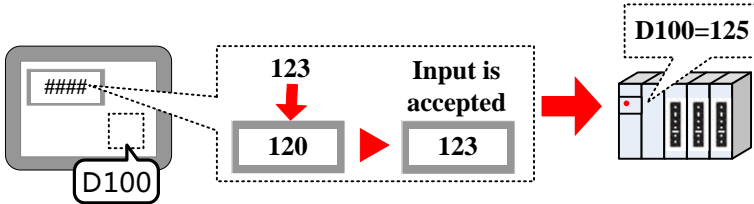
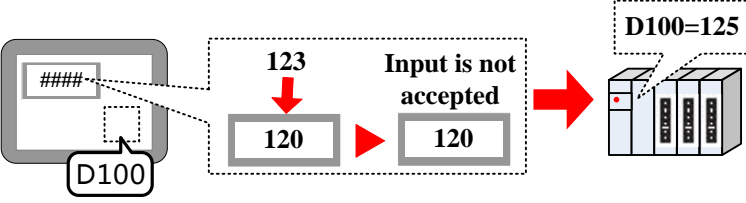
	<p>When window maximized</p> 
<p>Set at Window Minimized</p>	<p>When the window with this component is minimized, set the setting constant to a specified register automatically</p> <p>When window minimized</p> 
<p>Set at Backlight Off</p>	<p>When the backlight of the window that contains this component is off, set the setting value to a specified register automatically</p> <p>When backlight turned OFF</p> 
<p>Set at Enter success</p>	<p>In the window which contains this component, when a Number Input component inputs successfully, set the setting value to a specified register automatically</p> 
<p>Set at Enter Fail</p>	<p>In the window which contains this component, when a Number Input component inputs unsuccessfully, set the setting value to a specified register automatically</p> 
<p>Add value</p>	<p>The value in specified register will be added “Addend” every time presses this button, the result will not exceed the Upper limit</p>

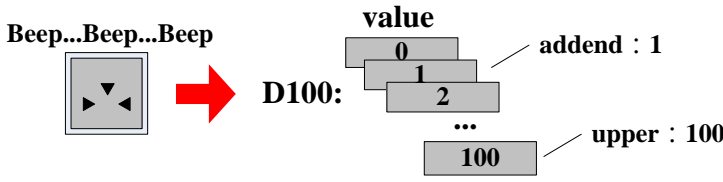
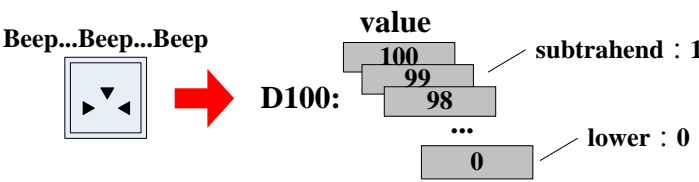
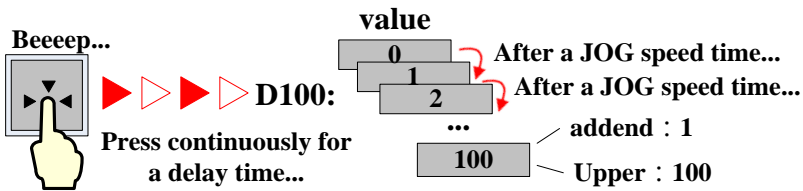
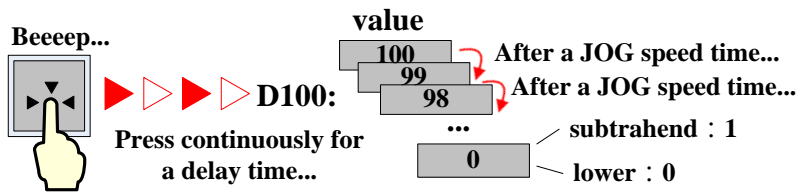
	
<p>Sub value</p>	<p>The value in specified register will be subtracted “Subtrahend” every time presses this button; the result will not exceed the Lower limit</p> 
<p>Jog++</p>	<p>If hold pressing the button exceeding the “Delay Time”, the value in specified register will be added “Addend” in a “Jog Speed” time. The result will not exceed the Upper limit</p>  <p>If the “Immediate Execution of Increase/Decrease Progressively” is checked, the value in specified register will be added “Addend” immediately at every press. If hold pressing the button, the value in specified register will be added “Addend” in every “Jog Speed” time until reaches the Upper limit</p>
<p>Jog--</p>	<p>If hold pressing the button exceeding the “Delay Time”, the value in specified register will be subtracted “Subtrahend” in a “Jog Speed” time. The result will not exceed the Lower limit</p>  <p>If the “Immediate Execution of Increase/Decrease Progressively” is checked, the value in specified register will be subtracted “Subtrahend” immediately at every press. If hold pressing the button, the value in specified register will be subtracted “Subtrahend” in every “Jog Speed” time until reaches the “Lower” limit</p>
<p>Jog++(Circle)</p>	<p>If hold pressing the button exceeding the “Delay Time”, the value in specified register will be added “Addend” in a “Jog Speed” time until reaches the Upper limit, then adds addend from the Lower limit</p>

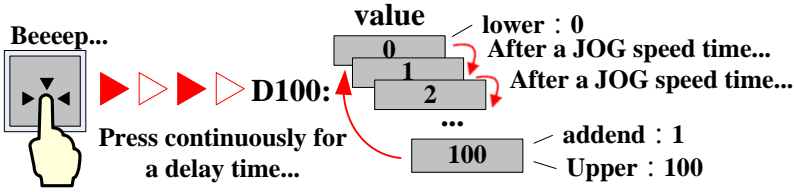
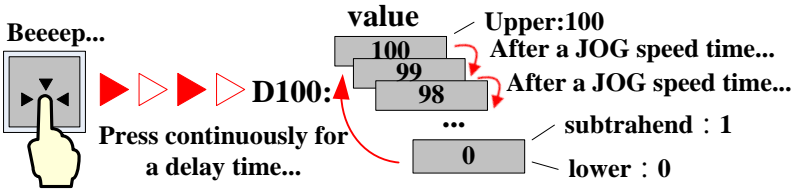
	 <p>If the “Immediate Execution of Increase/Decrease Progressively” is checked, the value in specified register will be added “Addend” immediately at every press. If hold pressing the button, the value in specified register will be added “Addend” in every “Jog Speed” time until reaches the Upper limit, then adds addend from the Lower limit</p>
<p>Jog--(Circle) e)</p>	 <p>If the “Immediate Execution of Increase/Decrease Progressively” is checked, the value in specified register will be subtracted “Subtrahend” immediately at every press. If hold pressing the button, the value in specified register will be subtracted “Subtrahend” in every “Jog Speed” time until reaches the “Lower” limit, then subtract subtrahend form the Upper limit</p>
<p>Variable Parameters</p>	<p>The parameters, like Set Value, Addend, Subtrahend, Upper, Lower, are read from specified registers</p>
<p>Key</p>	<p>Map the component to the F1~F12 of external keyboard or F1~F8 of the HMI which has keys itself. This function is suitable for the HMI with USB host or HMI with keys itself</p>

4.2.4 Multiple State Switch

The Multiple State Switch is the combination of Multiple State Display and Multiple State Setting. It displays the mapping status according to the value of Read Address (the maximum mapping status is 256). At the same time, it defines an area, when this area is touched, this component writes the mapping value to the Write Address. The Write Address and Read Address can be the same or different.

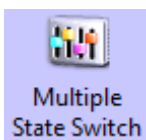

Mapping (For example)

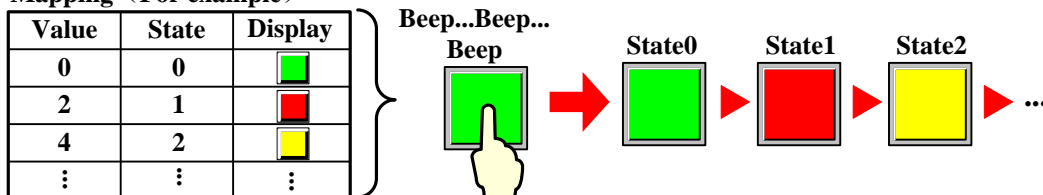

Multiple State Switch

Detail description of Multiple State Switch

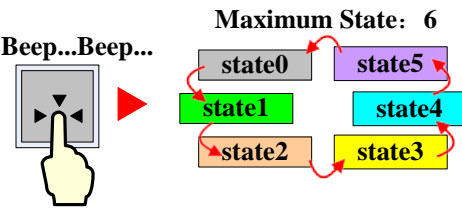
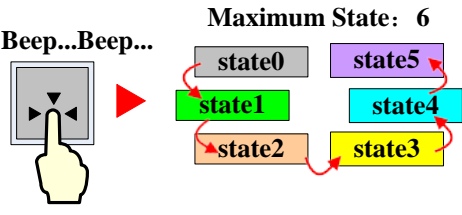
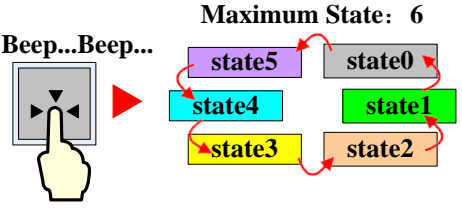
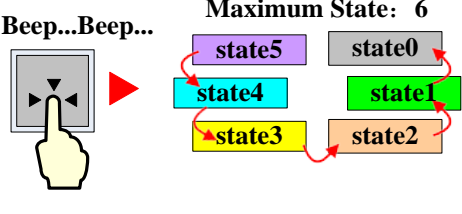
Control	Add	<p>The State No. adds 1 every time press this button, and the mapping value is write to the Write Address, at the same time this component displays corresponding graph according to the value of Read Address.</p> <p>Unloop unchecked:</p>  <p>Unloop checked:</p> 
Sub	<p>The State No. subtracts 1 every time press this button, and the mapping value is write to the Write Address, at the same time this component displays corresponding graph according to the value of Read Address.</p> <p>Unloop unchecked:</p>  <p>Unloop checked:</p> 	
List	<p>Display the state in list, and the current selected state is in Select Color</p>	

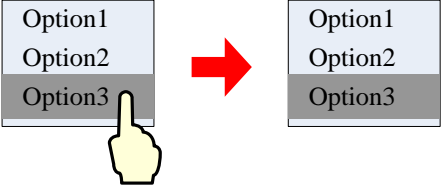
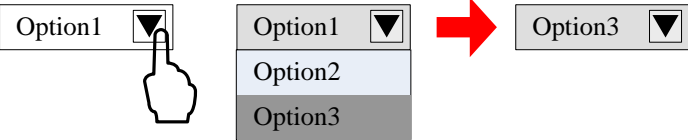
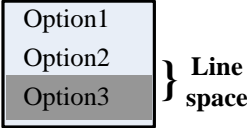
	
<p>Dropdown List</p>	<p>Display the state in dropdown list, but only display the current selected state. Click the dropdown list to display all the states</p> 
<p>State Num.</p>	<p>The maximum state number is 256.(The BIN or BCD encoding supports 256 states at most, and the LSB encoding supports 17 states at most.)</p>
<p>Map Value</p>	<p>When the value in Read Address equals one of the values in the Map Value list, the component displays the corresponding graph and tag. When the component switches to one state, the corresponding Map Value is write to the Write Address</p>
<p>Line Spacing</p>	<p>If chose the List or Dropdown List as control mode, this option is used to set the line space between each tag. The unit is pixel</p> 
<p>Key</p>	<p>Map the component to the F1~F12 of external keyboard or F1~F8 of the HMI which has keys itself. This function is suitable for the HMI with USB host or HMI with keys itself</p>

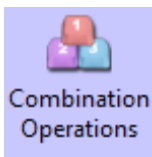

4.2.5 Combination Operations

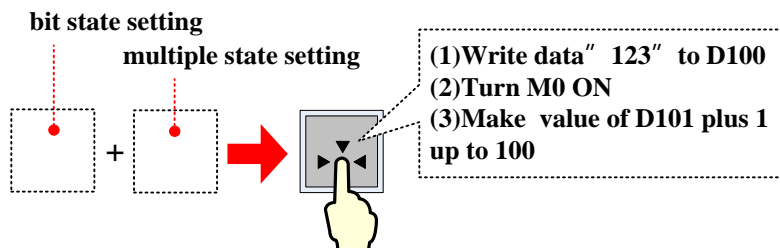

The Combination Operations is used to combine multiple bit state setting and multiple state setting as one component. So the operator can execute bit state setting and multiple states setting operation by Only one button.



Basic Attributes

Detail description of Combination Operations basic attributes	
Component List	Add multiple Bit State Setting and Multiple State Setting components by right click.
Write Address	Set the Write Address of the components in the Component List
Setting Mode	<p>Bit State Setting supports On, Off, and Toggle mode only.</p> <p> For details about Bit State Setting, refer to [Advanced Part 4.2.1 Bit State Setting]</p> <p>Multiple State Setting components support Set Constant, Add and Sub mode only.</p> <p> For details about Multiple State Setting, refer to [Advanced Part 4.2.3 Multiple State Setting]</p>
Exiting when component execution Fail	<p>If checked means that the execution will stop if one of the components fails during the sequence execution, the next component will not be executed. If unchecked means the Combination Operation executes from top to bottom, if one of the components fails during the sequence execution, then jump to execute the next component.</p>



1. When add the components, use the “Insert before” and “Insert behind” option to set the order of the components
2. Use the Move UP and Move Down to change the order in component list
3. Use the Delete option to delete components

4.2.6 Function Key

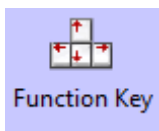

The Function Key provides functions like Switch Window, Keyboard Function, Clear Event, Touch Calibration, save Screenshot to Extended Memory, Execute Macro, and Print and so on. It also can be used to design the key board, and Function Key does not have control register, it executes functions by touch.



- Switch Window

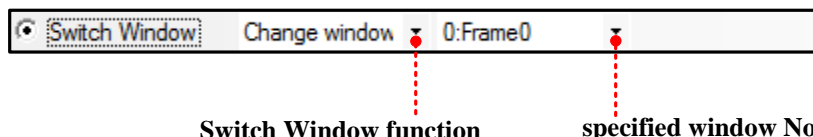

Description of Switch Window function	
Change Window	Press the function key to close the current window (sub windows in this window included) and switch to the window with specified window No.

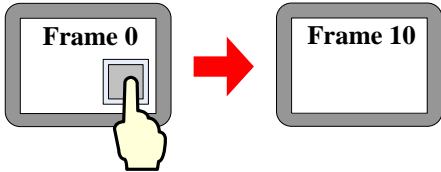
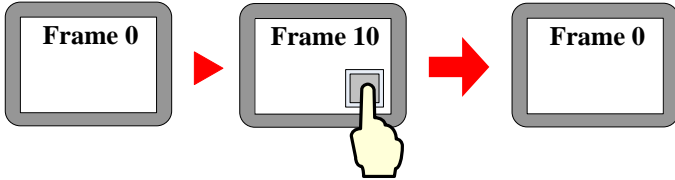
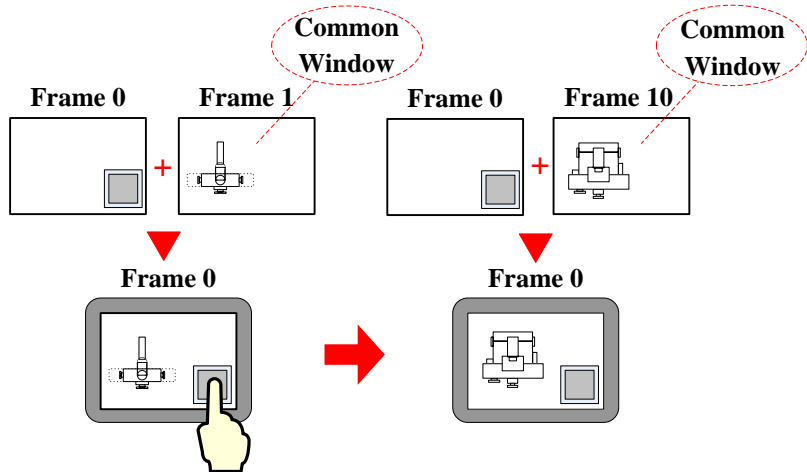
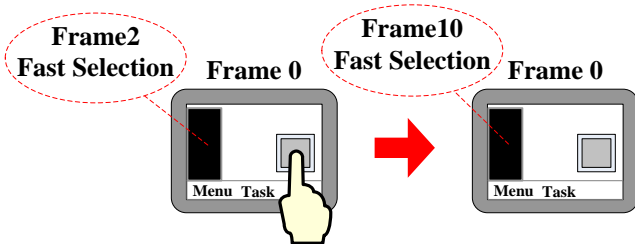
	
<p>Goto Prev</p>	<p>Press the function key to close the current basic window, and come back to the previous window. For example, switch fram0 to frame 10, press this function key in frame 10 to back to frame 0. This function is only suitable for basic window</p> 
<p>Change Common Window</p>	<p>If pressed, the Common Window (The default is Frame 1) will be replaced by the specified window as the new Common Window</p> 
<p>Change Fast selection window</p>	<p>If pressed, the Fast Selection Window (The default is Frame 2) will be replaced by the specified window as the new Fast Selection Window</p> 
<p>Pop up window</p>	<p>If pressed, the specified window will pop up, and displayed above the current window, the current window will not close</p>

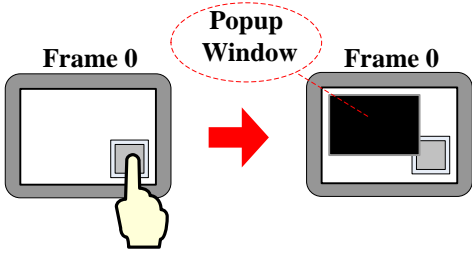
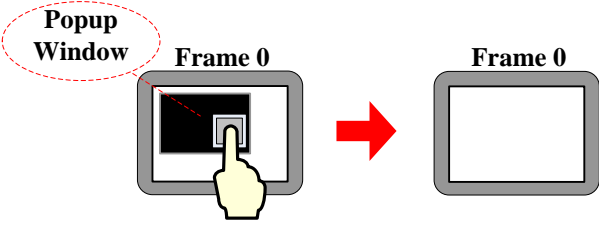
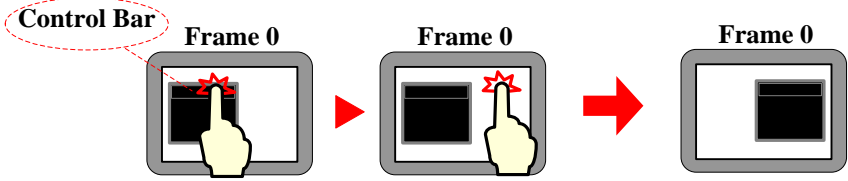
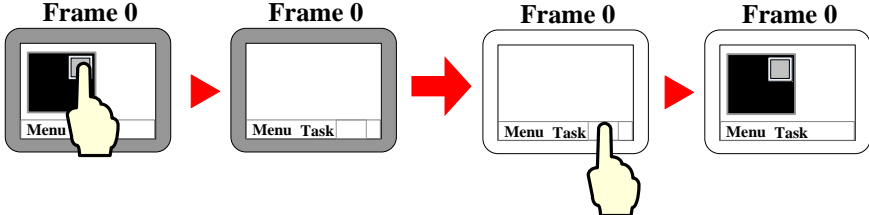
	
<p>Close Window</p>	<p>Use this option to close the pop-up window, but cannot close the Direct Window and Indirect Window, because they are controlled by the bit or word register. The Close Window function can close the pop up window only, but cannot control data in register</p> 
<p>Pop up window title bar</p>	<p>Hold pressing this function key to move the pop up window. This function is suitable for pup up window, direct/indirect window only</p> 
<p>Minimize</p>	<p>If pressed, the pop up window will be minimized in the task bar. Press the window icon on task bar to reset the window to original position. This function is suitable for pup up window, direct/indirect window only</p> 

● Map Keyboard

Use this function to make virtual keyboard.

Function description of keyboard	
Enter	The same function as the Enter on the keyboard
Backspace	The same function as the Backspace on the keyboard
Clear	Clear the content in the Number Input and Text Input component
Escape	Cancel operation, the same function as the ESC on the keyboard
Unicode	Set the input characters in the “Number Input” and “Text Input” component. The number (0, 1, 2...) or

	ASCII and Unicode (a, b, c...) are operational
Cursor	Move the cursor according to the mode, like Move up, Move down, Move left, Move right, Line head, Line tail, First position, Last position. This function is suitable for the Note Book component only
Select Text	Select text operation, Start select and Finish select included. This function is suitable for the Note Book component only
Text Operation	Set the text operation, includes Copy, Cut, and Paste. This function is suitable for the Note Book only

- Execute Macro



Chose the macro

Press function key to execute the existing macro.



Mapping Key

The operation of mapping key

This function can set function for the F1~F8 of HMI, includes Along, Backwards, ESC, Enter and so on. This function is suitable for MT4201T HMI only.

- Touch Calibration

Press function key with this option checked to enter the touch calibration screen. Customer can calibrate the touch panel.



Enter the calibration screen without set the DIP switches

- Clear Event

Press function key to clear the event information in the Event Display component.

- Save Screenshot to The Extended Memory.

Press function key to save the screenshot to the extended memory in bmp picture. So the customer can print or check the screen of HMI.

[For details about Save Screenshot to the Extended Memory, refer to \[Advanced Part 4.15.5 PLC Control\]](#)

- Import/Export

Press function key to import/export project or recipe data.



This function must works with the File List Window and only the HMI with USB host or SD card supports it

Description of Import/Export function	
<p>Import project to HMI</p>	<p>Import the project (pkg file) from extended memory to HMI. After that, HMI will restart automatically and run the project.</p> <p>Pop up Frame 5</p> <p>PKG LOAD OK</p>
<p>Export Project from HMI</p>	<p>Export the project(pkg file) in HMI to extended memory</p>

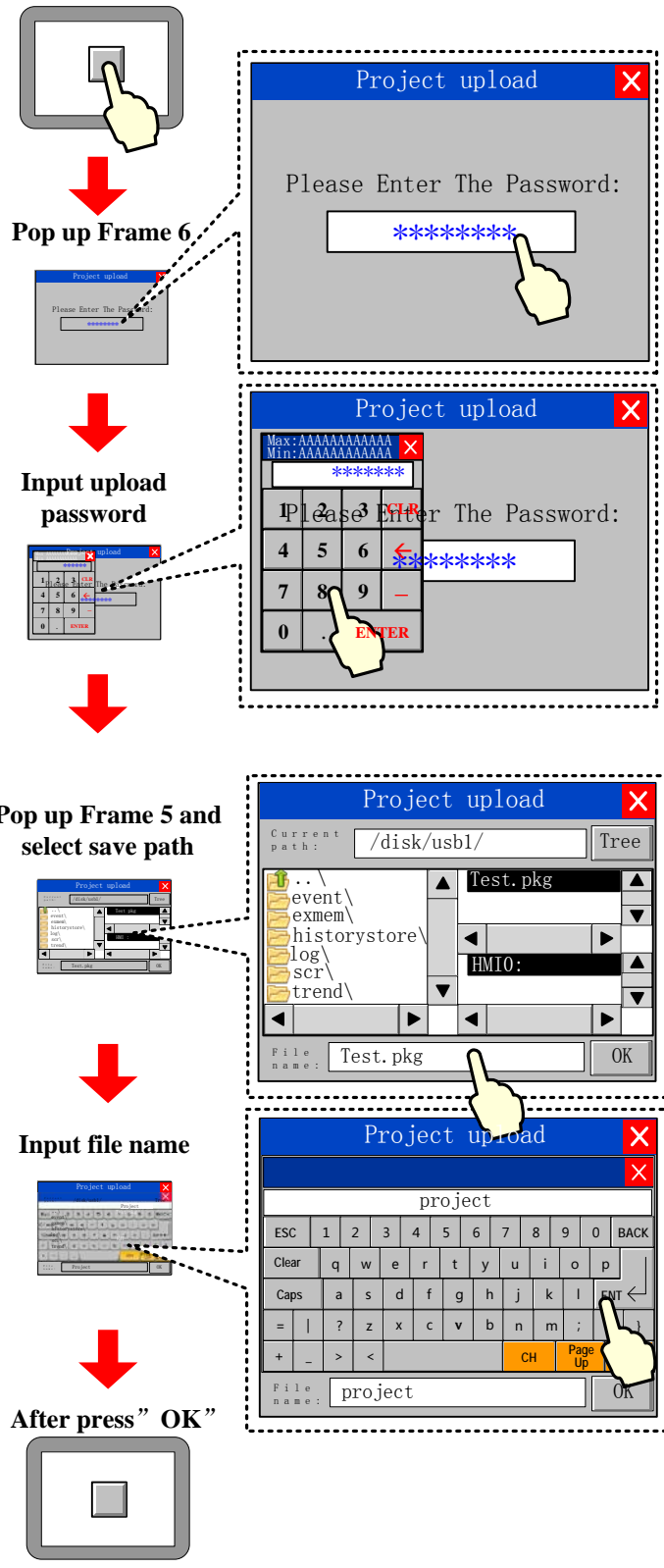

Import Recipe to HMI	Import the recipe file (.rcp) in extended memory to HMI. The operation steps are the similar with Import Project to HMI
Export Recipe from HMI	Export the recipe file (.rcp) in HMI to extended memory. The operation steps are the similar with Export Project from HMI

- Message Board

This function works with the Message Pad; it can be used as an assistant tool of Message Pad.

Description of Message Board		
Tool	Pen	Press the function key to set the tool as a pen for Message Pad
	Erase	Press the function key to set the toll as an eraser for Message Pad
	Clear Block	Press the function key to clear the selected area of the Message Pad
Pen Color		Set color of pen
Pen Width		Set width of pen, 1~8 pixel are optional
Clear		Press function key to clear all content on Message Pad

- Print

Press function key to print the current screen.

[For details about print, refer to \[Advanced Part 4.15.5 PLC Control\]](#)

- Map Keyboard

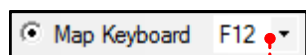

Map the F1~F12 on the keyboard

Map the function key to the F1~F12 of the keyboard. This function is suitable for HMI with USB host only.

4.3 Lamp Component

4.3.1 Bit State Lamp



The Bit State Lamp is used to indicate the state (0 or 1) of bit register in HMI or PLC. It can display tag text and graphic.

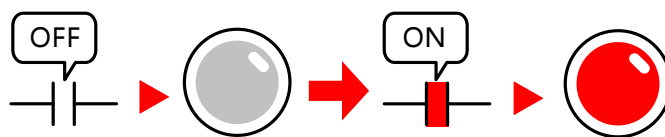

Detail description of Bit State Lamp	
Function	Description
Normal	Display the corresponding graphic according to the state. This graphic isn't blinking

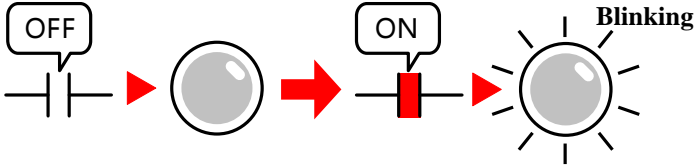
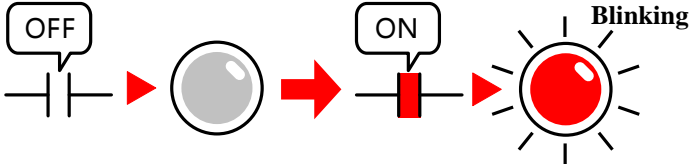
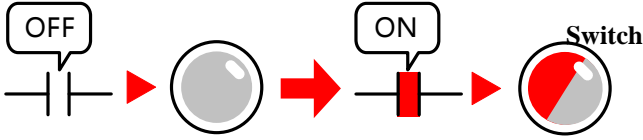
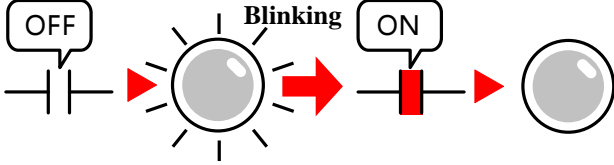
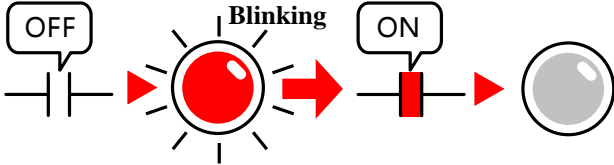
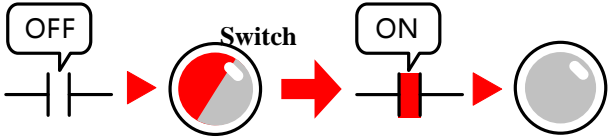
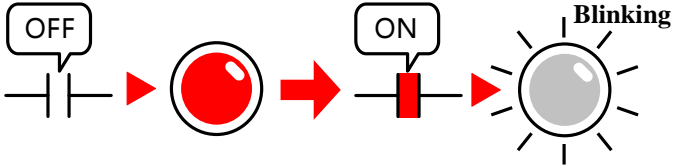
<p>Value 1 Blinking on state 0, value0 Showing state 0</p>	<p>The blinking frequency (Rate) can be set.</p> 
<p>Value 1 Blinking on state 1, value0 Showing state 0</p>	<p>The blinking frequency (Rate) can be set</p> 
<p>Value 1 switch Blinking on state 1 and 0, value0 Showing state 0</p>	
<p>Value 0 Blinking on state 0, value 1 Showing state 0</p>	<p>The blinking frequency (Rate) can be set.</p> 
<p>Value 0 Blinking on state 1, value 1 Showing state 0</p>	<p>The blinking frequency (Rate) can be set</p> 
<p>Value 0 switch Blinking on state 1 and 0, value 1 Showing state 0</p>	
<p>Value 1 Blinking on state 0, value 0 Showing state 1</p>	<p>The blinking frequency (Rate) can be set</p> 
<p>Value 1 Blinking on state 1, value 0 Showing state 1</p>	<p>The blinking frequency (Rate) can be set</p>

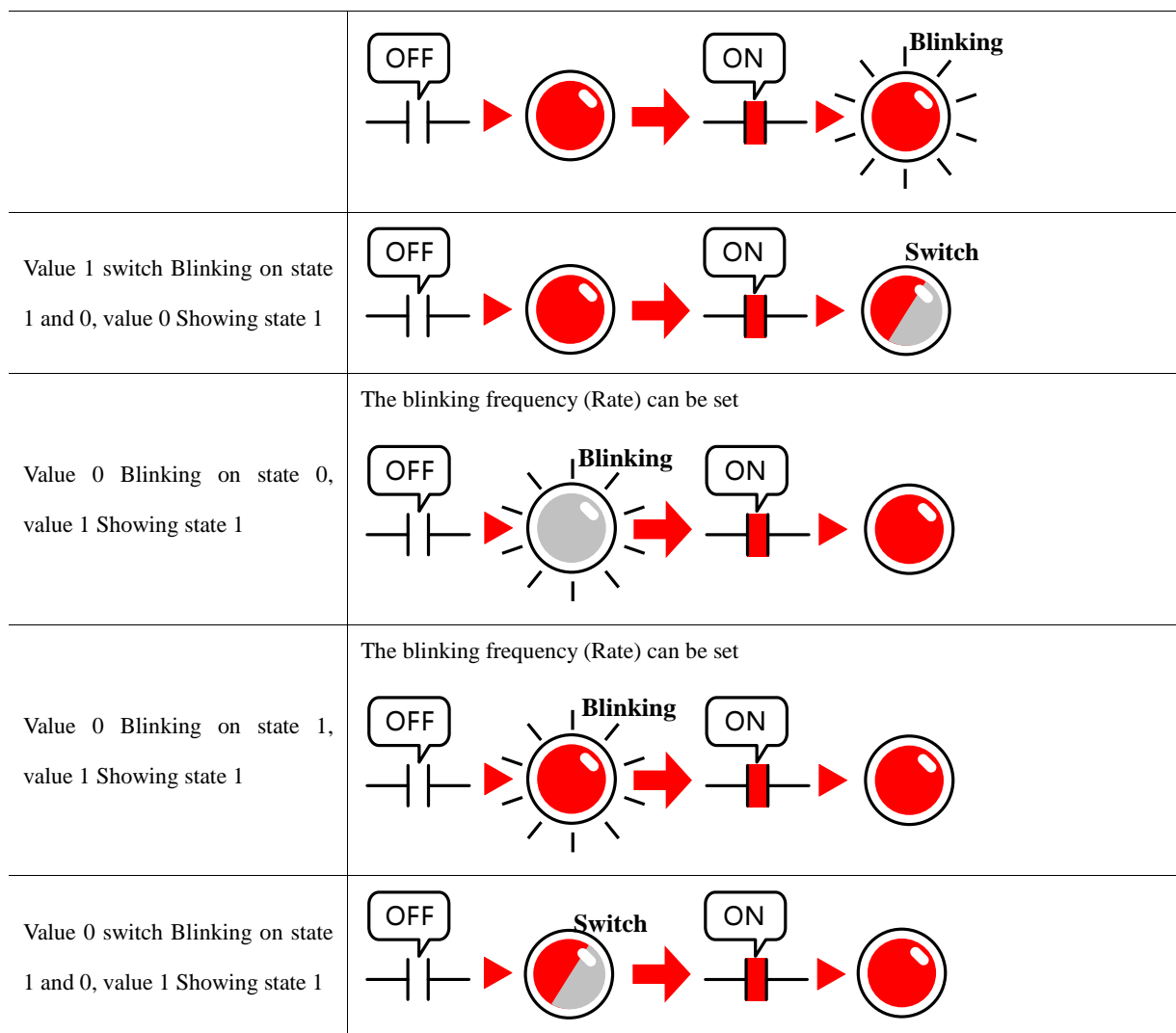

4.3.2 Multiple State Display



The Multiple State Display displays the mapping state according to the value in the specified HMI register or PLC register. It supports 256 mapping states at most.

D100 mapping(For example)

Value	State	Display
0	0	
2	1	
4	2	
⋮	⋮	⋮

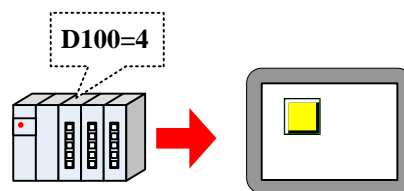

Multiple State Display

Description of Multiple State Display	
State Num.	Set the state number of Multiple State Display, it is up to 256. (The BIN or BCD encoding supports 256 state at most, and the LSB encoding supports 17 states at most)

Data Mapping	Set the mapping value of each state. When the value in specified register equals the setting value, the component displays corresponding state
--------------	--

4.4 Number Components

Number components include Number Input Component and Number Display Component. They are used to write data to a specified register or read data from a register and display this value.

- Common Attributes of Number Component.

Numeric Data

Description of number		
Data type	signed int	Display the data in signed decimal integer (0~9) format. 16 bits data range: -32768~32767; 32 bit data range: -2147483648~2147483647
	unsigned int	Display the data in unsigned decimal integer (0~9) format. 16 bits data range: 0~65535; 32 bit data range: 0~4294967295
	Hex	Display the data in hex (0~F) format. The integer part can be set, no decimal. 6 bits data range: 0~65535; 32 bit data range: 0~4294967295
	Bin	Display the data in binary (0, 1) format. The integer part can be set, no decimal. 6 bits data range: 0~65535; 32 bit data range: 0~4294967295
	Password	Display data in "*" format. Only the data type and data width can be set, other options are ignored
	Float	Transform the 32 bits IEEE float data to decimal data and display in decimal. The default data width is DWORD
	Double	Transform the 64 bits IEEE float data to decimal data and display in decimal. The default data width is 4-DWORD
Data Width	Set the data width of the register 16 bits or 32 bits(WORD or DWORD)	
Integer/Decimal	Set the display bit number before and behind decimal dot	
Show plus sign	When the data type is signed int, click this option to display the "+" symbol before positive number	
Max/Min Value Setting	Set input/display range for Number Input/Display Component. "Variable Max/Min Value" checked means that the Max/Min Value is variable, and set read register of this variable. The word length of this register depends on the data width of component. For example, the Max/Min Value is LW0, if the word width is WORD, the LW0 is minimum value register, LW1 is Maximum value register; and if the word width is DWORD, the LW0 and LW1 are minimum value registers, LW2 and LW3 are the maximum value registers	
Off normal upper/lower	If the data is exceeds the Max/Min Value range, the component will display the data in the setting color.	

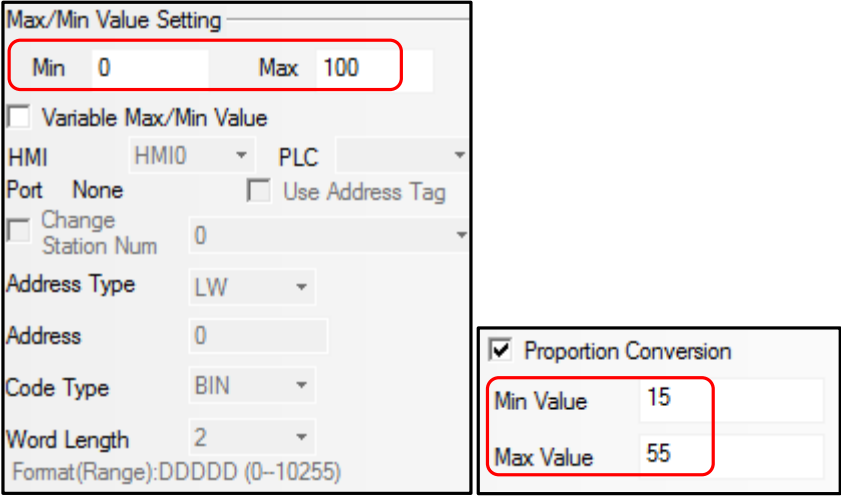
Flash	If the value in certain register exceeds the upper limit or lower limit, the data in the component will be flashing to enhance the alarm effect.
Proportion Conversion	<p>The data will be displayed after calculating by proportion, the Min Value and Max Value is must be set in the function. For example, the original data is A, and the displaying data is B. Then the relationship between is as followings:</p> <p>$B = \text{Min Value} + (A - \text{Min}) * \text{Proportion}$ and the $\text{Proportion} = (\text{Max Value} - \text{Min Value}) / (\text{Max} - \text{Min})$</p> <p>For example the original data is 20, according to the following setting, the displaying data is $15 + (20 - 0) * (55 - 15) / (100 - 0) = 23$. So the component displays 23</p> 

※ For signed/unsigned int, if the Decimal is set, the original data will be displayed after left shift the Decimal bits, but also set the original data to the register.

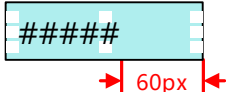

Description of Font	
Alignment	<p>Set the display position of data,, it has for methods , they are Left, Right, Leading 0, Center.</p> <p>For example, the Integer is 5, Decimal is 0, input value is 123, then the following are the displaying in four different methods:</p> <p>Left 123</p> <p>Right 123</p> <p>Leading 0 00123</p> <p>Center 123</p>
Font Adjustment	Add the width of display area, the units is pixel

	<p>Horizontal Increased 0 pixel </p> <p>Horizontal Increased 60 pixel </p>
Key	Map the component to the F1~F12 of external keyboard or F1~F8 of the HMI which has keys itself. This function is suitable for the HMI with USB host or HMI with keys itself

● Related Attributes Setting of Numeric Data

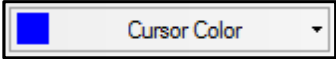
Other Related Attributes	
Cursor	<p>Set the Cursor Color when Numeric Data is triggered in the HMI Extended Attributes of HMI Attributes.</p> 

4.4.1 Number Input

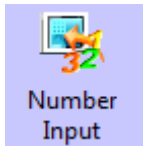

Number Input Component write the data in value to the certain HMI or PLC register, at the same time display the written date on HMI.

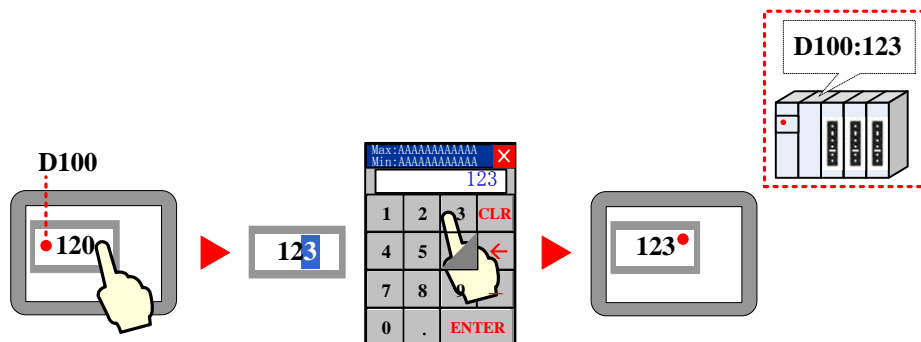

Keyboard Setting

Attributes Description of Keyboard Setting		
Public Keyboard	Windows	Use the Public Windows Keyboard It is the default setting , and use the keyboard in Frame3: NUM Keyboard
Specified Keyboard		Use the specified keyboard in designated window. If use the self-made keyboard, the window where the keyboard is should set the Keyboard Page in Window Attribute, so the window number can be displayed in the Specified Keyboard list
Keyboard Position	Pop-Up	Set the keyboard pop-up position on HMI
Do not Use Pup-Up		When the Number Input Component is triggered, do not pup up keyboard. The HMI supports

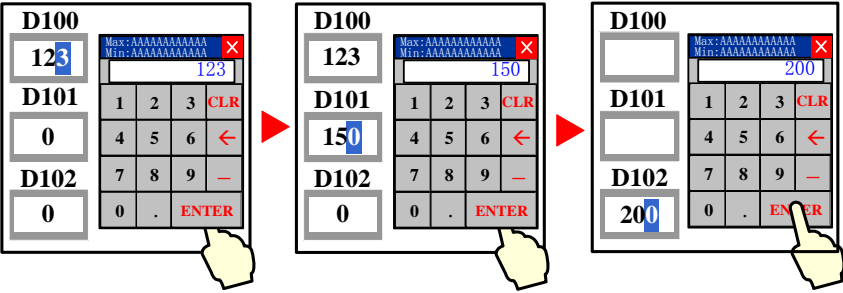
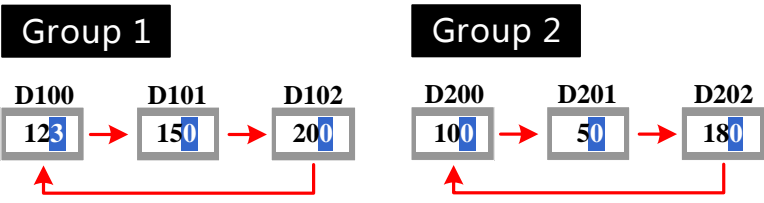
Keyboard	USB can use the external keyboard
Use Input Order	<p>The popped-up keyboard can input data to the components continuously by order. During the input operating, the keyboard will not disappear when press ENTER, and the input cursor will flash among the component in circle. The keyboard will be closed by press Close button</p> 
Input Order	Set the input order number for the component
Group	<p>For multiple groups of components that need input the data continuously, the first triggered component decides where the cursor circles</p> 

[For details, refer to \[Advanced Part 2.4 Keyboard\]](#)

4.4.2 Number Display



Number Display is used to display the value in specific HMI or PLC register on HMI.

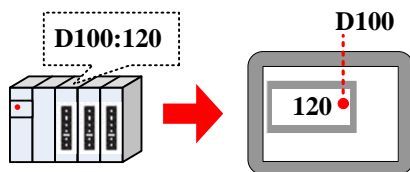

4.5 Text Components

The text components contain Text Input, Note Book, Text Display, they are used to decode the data by ASCII then write it to specific register in character string or read data from specific register then display it in character string after the data decoded by ASSIC

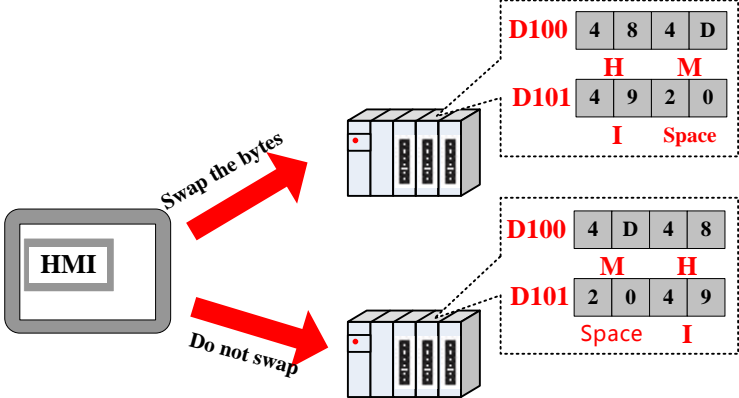

- Common Attributes Setting of Text Components

Basic Attribute

Common Attributes Description of Text Component	
High byte and low byte swaps	<p>Swap the high byte and low byte, then display the high byte on the left and low byte on the right</p> 
Unicode	If checked, the text content is decoded by Unicode and displayed. It is usually used to display multiple languages
Extended ASCII	This mode can display the extended ASCII character between 0X80~0XFF. If checked, the text cannot display Chinese character; the Unicode and Extended ASCII cannot be chosen at the same time
Word Length	The word length is 1~16 optional. Each word contains 2 ASCII characters

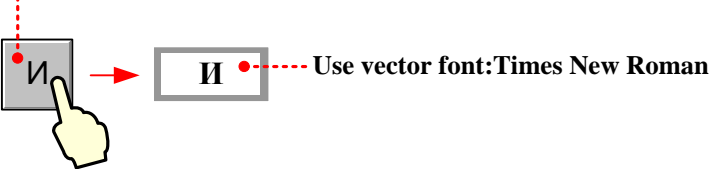
Font

Description of Font Attribute	
Font Type	<p>Use the Vector Font or Dot Matrix Font to display character string</p> <p>Note: Generally speaking, if it is not ASCII character, it cannot be displayed by vector font, but the Unicode character input by Unicode keyboard with same character tag can be displayed by vector font. For example:</p> <p>Function Key(With the same character tag)</p> 

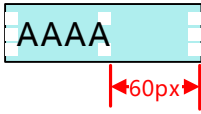
<p>Align ment</p>	<p>Set the displaying position of character string, including two methods: Left, Right.</p> <p>Left </p> <p>Right </p>	<p>Font Adjust ment</p>	<p>Add the display area width at the right side, the units is pixel.</p> <p>Font Adjustment 0 pixel </p> <p>Font Adjustment 60 pixel </p>
<p>Key</p>	<p>Map the component to the F1~F12 of external keyboard or F1~F8 of the HMI which has keys itself. This function is suitable for the HMI with USB host or HMI with keys itself</p>		

Keyboard Setting

Description of Keyboard Setting Attributes	
<p>Public Windows Keyboard</p>	<p>Use the public windows keyboard, the default keyboard is the [Frame3:NUM Keyboard]</p>
<p>Specified Keyboard</p>	<p>Use the keyboard in specified window. The default keyboard is the [Frame 4: ASCII Keyboard] If you use the self-regulating keyboard, you should set the Special Attribute in HMI Attribute to Keyboard Page, then you can select the Window's number in Specified Keyboard list</p>
<p>Keyboard Pop-up Position</p>	<p>Set the position of the pop-up window in the screen</p>
<p>Not Use pop-p Keyboard</p>	<p>Do not pop up keyboard when trigger text input or text book component, but use the external USB keyboard if the HMI supports the USB host</p>
<p>Use Input Order</p>	<p>Input the component continuously when the keyboard is popped up, the keyboard will not be closed when press the ENTER key during the inputting, the input cursor will flash in cycle among the components that set the Input Order, the keyboard will be closed when click the Close button</p>

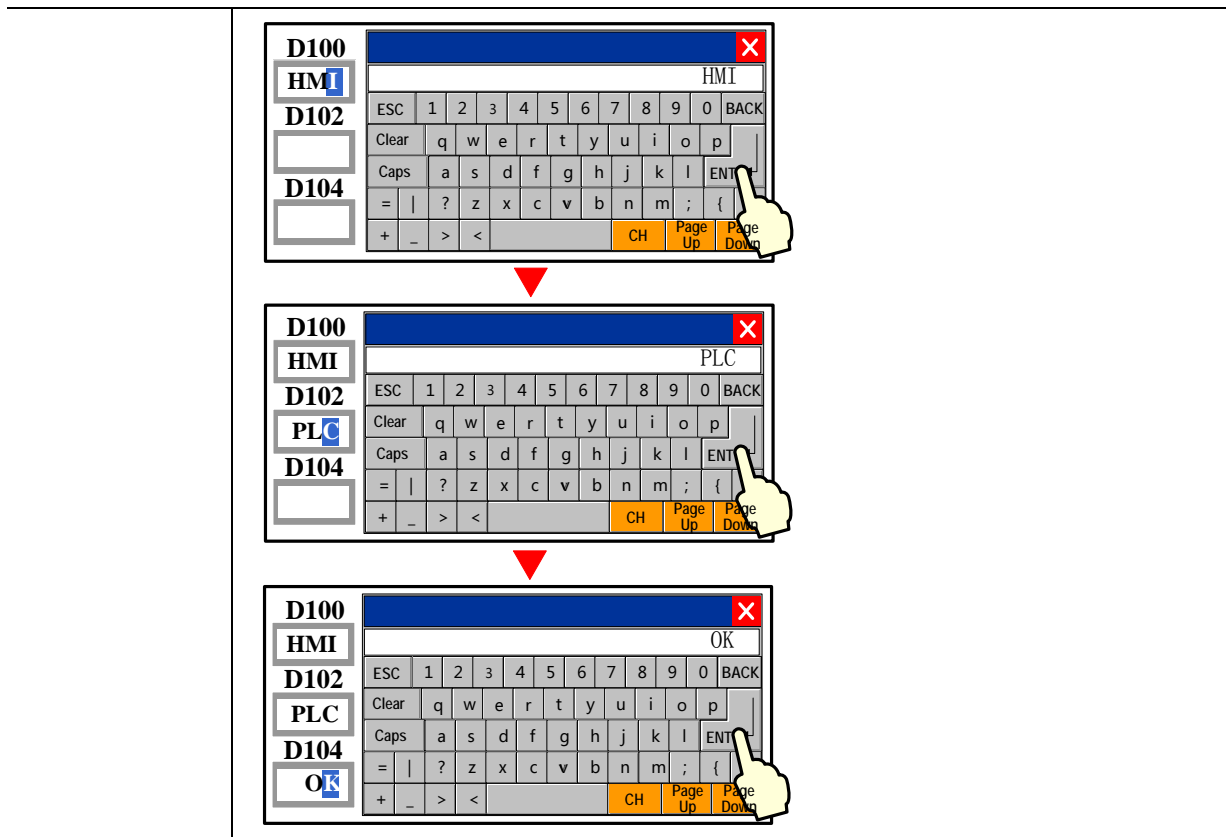

Input Order Set the input order for the components

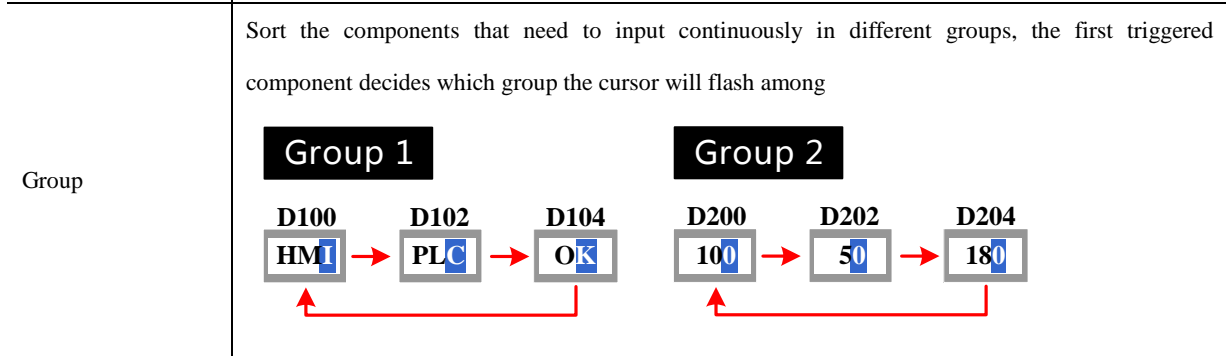

[For details, refer to \[Advanced Part 2.4 Keyboard\]](#)

- Related attributes settings about the Text component

Description of related attributes	
Cursor Color	Set the cursor color when the Text Input component or Note Book component is triggered in the HMI Extended Attributes of HMI Attributes For details, refer to [Advanced Part 6.1.3 HMI Extended Attributes]
Cursor Move	Use the Keyboard Function in the function key to move the cursor <input type="checkbox"/> Refer to Advance Part 4.2.6 Function Key for more information.
Text Operation	Use the Keyboard Function in the function key to select, copy, cut, and paste the text content.

[Refer to Advanced Part4.2.6 Function Key for more information.](#)

4.5.1 Text Input



The Text Input decodes the data according to ASCII, and then writes it to the HMI or PLC register in character string, at the same time displays the written data in character string on HMI. The written data is saved in the continuous registers that begin from "Read Address". When displaying the data, the low byte characters are displayed on the left and the high byte characters are displayed on the right.

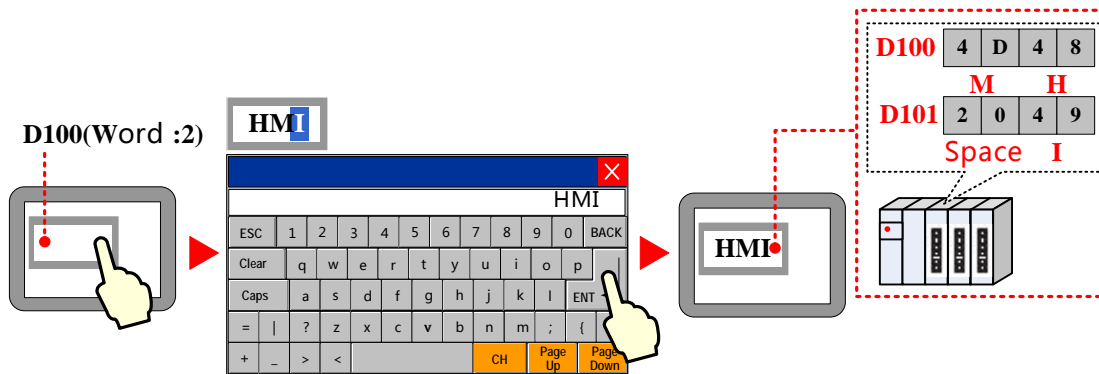

The Text Input component cannot display the multiple rows text content

4.5.2 Text Display

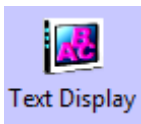

The Text Display component displays the HMI or PLC data in character string on HMI after decoding it according to the ASCII.

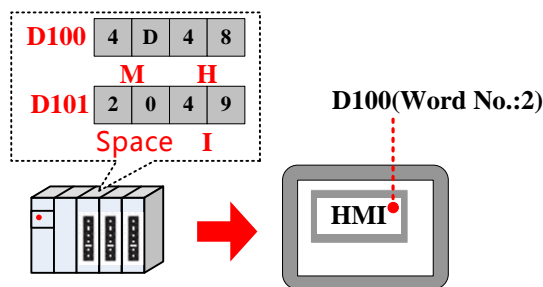

The Text Display component cannot display the multiple rows text content

4.5.3 Note Book

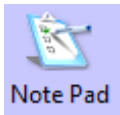

The Note Book is the same as the Text Input; they decode the data according to ASCII, and then write it to the HMI or PLC register in character string, at the same time displays the written data in character string on HMI. The written data is saved in the continuous register that begins “Read Address”. When displaying the data, the low byte characters are displayed on the left and the high byte characters are displayed on the right.

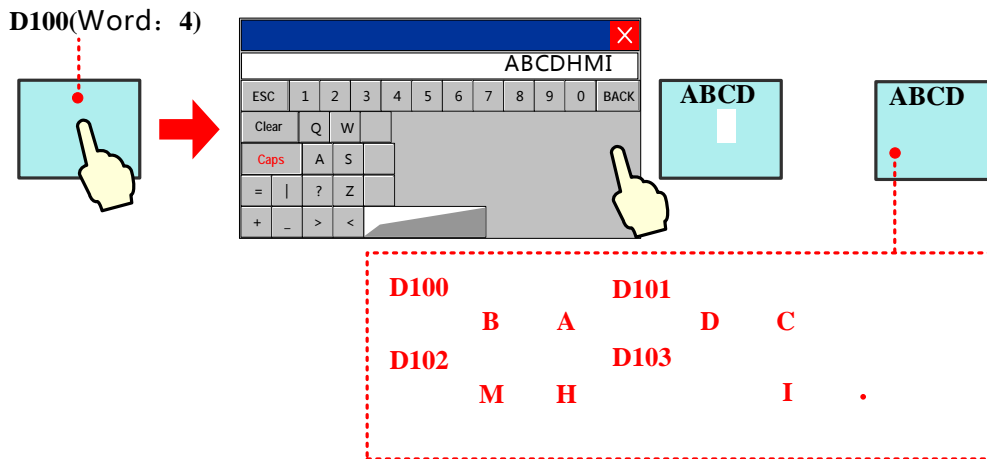

The Note Book component can display the multiple rows text content

Note Book

Description of Note Book attributes			
Total Lines	The total lines of input text	Display Line	Display area line
The Word Register Number of Per Line	The most data length per line, the unit is word. A length of a ASSIC character is a byte, and 1word = 2 bytes		

4.6 Graph/Meter Components

In Kinco HMIware, customer can display the data in chart/graph. The graph/meter components contain Trend Curve, XY plot, Oscillograph, Bar Picture, Meter and so on.

The Trend Curve, XY plot and Oscillograph are graphs; they are usually used to display data in a single or a series of continuous registers in graph on HMI. The customer can use them according to their function and actual application.

- The common attributes of graph setting.



Basic Attributes

Description of Basic Attributes			
Component	Trend Curve	XY Plot	Oscillograph
Read Address	Set the sampling register address of the first channel	Set the sampling register address of the first channel. The address assigning depends on the type of XY plot	Set the sampling register address of the first channel
Word Length	It depends on the sampling channel number, if the channel is m,(m<17), the word length is m	The word length depends on the channel number, sampling points, XY plot type and the read register type. The user can not change this	It depends on the channel number and sampling rate. If the channel number is m(0<m<17) and sampling rate is n(0<n<256), the word length is m*n

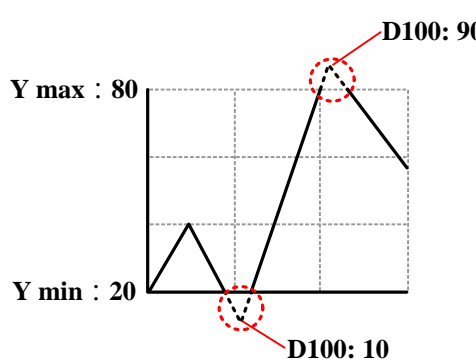
Channel

Detail description of channel attributes.	
Line Width	Display the width of the curve
Data Type	Set the data format of sampling data. It contains 16-bit signed, 16-bit unsigned, 32-bit signed, 32-bit unsigned, float and double
Y max/Y min	<p>Set the display range of sampling data on X axis and Y axis</p> 
Color	Set the color of curve
Channel use variable limit	The Y max/Y min value is from specified registers. In multiple channel application, user can set specified registers for Y max/ Y min of each channel. Trend Curve: if the Specified Address is Y min; the Specified Address+1 is the Y max. XY plot: if the Specified Address is Y min, the Specified Address+1 is the Y max, the Specified Address+2 is the X min and the Specified Address+3 is the X max. Oscillograph: if the Specified Address is Y min, the Specified Address+1 is the Y max

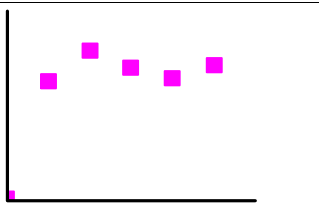
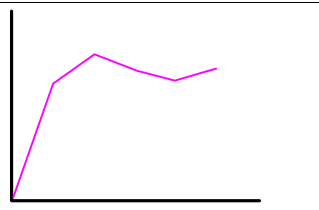
Extended Attributes

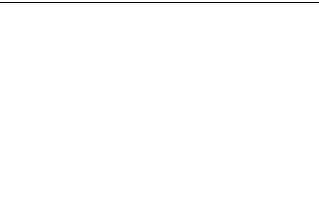
Detail description of extended attributes				
Channel Properties	Chose a channel to edit. The available channels depend on the channel number set in Trend Graphics or XY Curve Graphics or Scope Chart page. And set the line style and line width			
Connect Style	Dot		Line	
	X axis projection		Y axis projection	
Node Graph	Chose the graph of nodes, the following six types are available ●▲■□△×			
Node Size	Set the size of node	Node Color	Set the color of node	
Use Grid	The curve use the background and grid, users can set the line and row number, as well as the line width, color and type			
Variable Period	When use the Time sampling, the Circle time can be read from specified register. Note: The Oscilloscope does not support variable period	Number of points	The number of sampling points can be read from specified register	



If the circle period and sampling point number use the variable value, the variable value will be used in priority. And the default value will be used if the variable value cannot be got because of the communication problem

Historical Data Storage

[For details, refer to \[Advanced Part 4.1.10 Save Historical Data\]](#)



The Trend Curve and Historical Data Display can be used at the same, but when the trend curve and historical data display sample the same register and the data is saved in external device, the Subdirectories should be different, or the only save historical data in just one of the component

- About the display of curve.

The Trend Curve and XY plot run at the backstage, the trend curve and XY plot will not be cut off when changing the frame.

On the other hand, the Oscilloscope does not support running at backstage; the data sampling and curve will be cut off

when changing the frame.

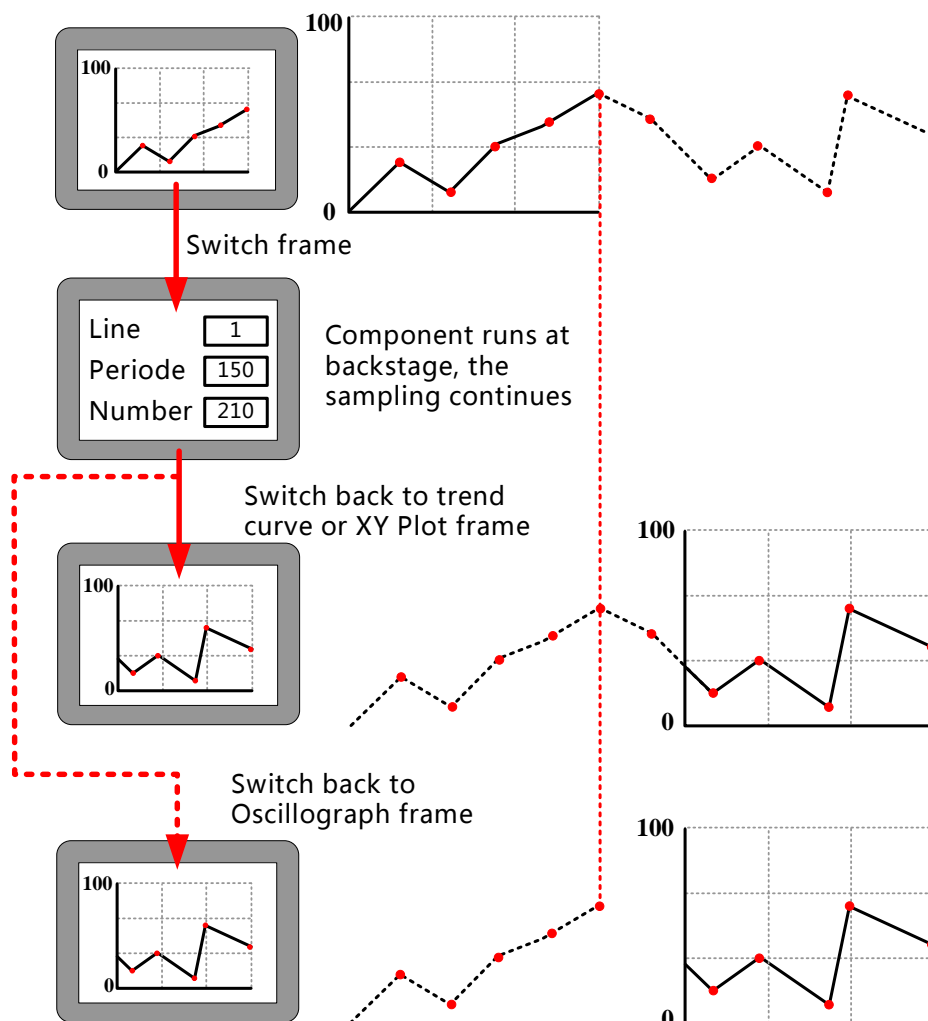

The special attributes of these curves are as follows.

4.6.1 Trend Curve

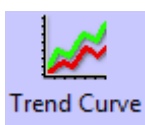

The Trend Curve reads a series specified continuous registers (in HMI or PLC) in period and display them in curve. The new data will be read from specified registers and displayed at the right/left/top/down side of curve, it is a real-time curve.

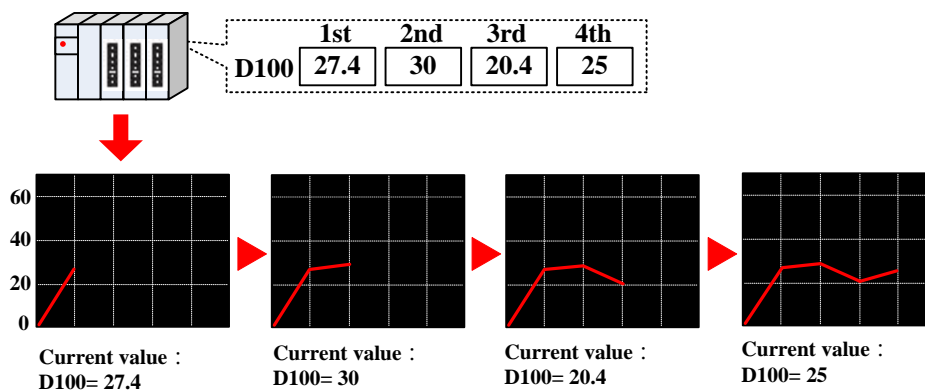

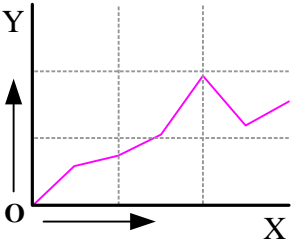
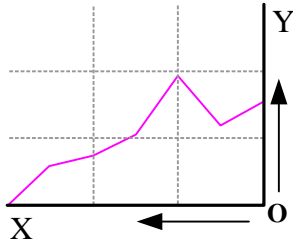
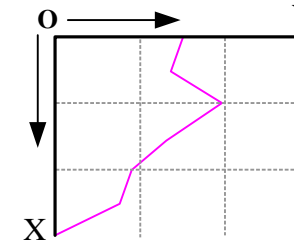
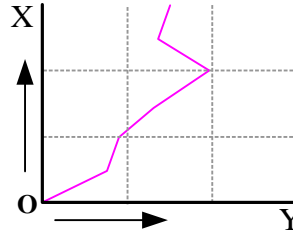
Detail description of trend curve attributes				
Type	Single page	Only display the sampling value in current page, there is no extended curve		
	Multiple pages	There is extended curve. When the curve goes on, the previous sampling data will not disappear. The historical data will be stored in the buffer area		
Attributes	Start from left		Start from right	
	Start from top		Start from bottom	
	Time sampling	Sample the date timely		
	Sampling Methods	OFF→ON trigger sampling	The sampling will be triggered when specified register changes from OFF to ON	
ON→OFF trigger sampling		The sampling will be triggered when specified register changes from ON to OFF		
OFF↔ON trigger sampling		The sampling will be triggered when specified register changes		
OFF→ON reset trigger sampling		The sampling will be triggered when specified register changes from OFF to ON. And the specified register will be reset to OFF automatically		
ON→OFF reset trigger sampling		The sampling will be triggered when specified register changes from ON to OFF. And the specified register will be reset to ON automatically		
Cycle		The time interval between two sampling points. The unit could be 1s or 100ms		
Sam.Type	Continue	The sampling will continue even the all sampling points are finished		
	Once	The sampling will stop automatically when all the sampling points are finished, the sampling executes only once		
Sampling points	Sampling points on each page			
PageNum	This option is valid in the Multiple Page type			
Channel	The number of the channel, it is 16 channels at most			

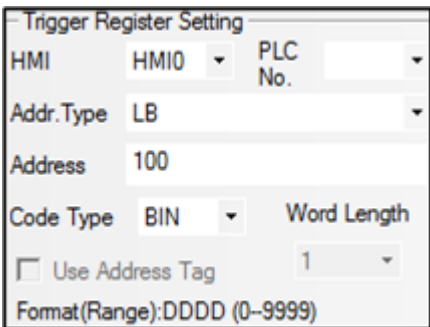
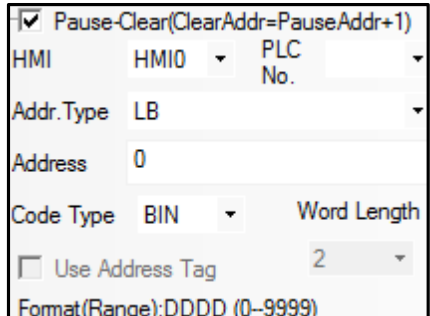
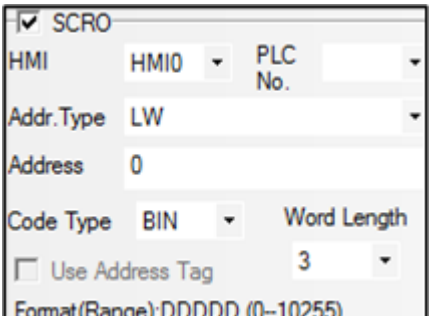
<p>Control Register Setting</p>	<p>This option is valid in the trigger sampling .Take the following picture for example, the LB100(bit register in the HMI) is the trigger register, when the LB100 satisfies the setting condition in the Sampling Method , the sampling will be triggered</p> 
<p>Pause-Clear</p>	<p>Set the Pause and Clear register, the default word length is 2, the set address is used to stop the curve, and the set address +1 is used to clear the curve. The Pause function just stops the change of curve, but not stops the sampling. The Clear function will clear the curve on the Trend curve. Take the following picture for example, the LB0(bit register in HMI) is set to control the Pause-Clear function, when the LB0 is ON , curve will stop refreshing, when the LB0 is OFF , the curve will continue to display, when the LB1 is ON the curve on the Trend Curve will be cleared</p> 
<p>SCRO</p>	<p>Set the register to turn the page of Multiple Page curve, default word length is 3. This option is valid when the Multiple Page is chosen. Use this function to browse multiple page curves, and this function can be used with Scroll Bar. For details, refer to [Advanced Part 4.16.3 Scroll Bar]</p> <p>Take the following picture for example, if the specified register is LW0(word address in HMI), so the LW0 is the current browsing index value of scroll bar, the LW1 is the start browsing index value, and the LW2 is the max browsing index value</p> 

This option is used to save the start sampling time and end sampling time of current page, this option is valid when the Save Time option is chosen. Default word length is 12. Take the following picture for example, if the specified address is LW70(word register in HMI), the start time of current time (second, minute, hour, day, month, year) are LW70, LW71, LW72, LW73, LW74, LW75. The end time of current page (second, minute, hour, day, month, year) are LW76, LW77, LW78, LW79, LW80, LW81

Time

Time
 HMI HMI0 PLC No.
 Addr.Type LW
 Address 70
 Code Type BIN Word Length
 Use Address Tag 12
 Save Time
 Format(Range):DDDDD (0-10255)



If “Use scroll bar” is selected in [Trend Graph Component Attribute]-[Scale], the [Scroll] cannot be selected in [Trend Graph Component Attribute]-[Trend Graphics].

Scale

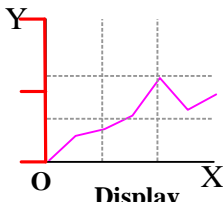
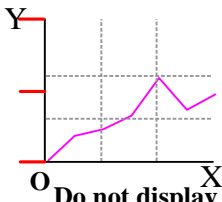
Description of Scale attributes		
Use Scroll Bar	The trend curve uses the system scroll bar, user can set the scroll bar width, the width range is 20~120, units is pixels.	
Use Vertical Axis Scale	The trend curve uses the system vertical axis scale.	
	Scale color	Set the color of vertical color.
	Display Scale Frame	Display the scale frame or not. <div style="display: flex; justify-content: space-around; align-items: center;"> <div style="text-align: center;">  <p>Display</p> </div> <div style="text-align: center;">  <p>Do not display</p> </div> </div>
	Major Scale Number	Set the major scale number.
	Major Scale Length	Set the major scale length, the unit is pixels.
	Minor Scale Number	Set the minor scale number.
	Minor Scale Length	Set the minor scale length, the unit is pixels.

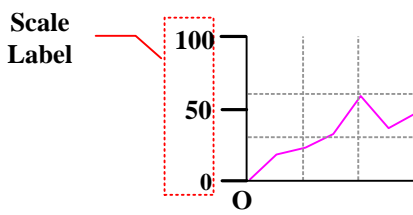
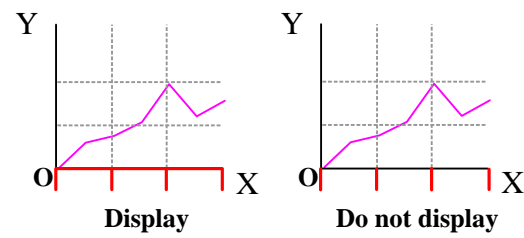
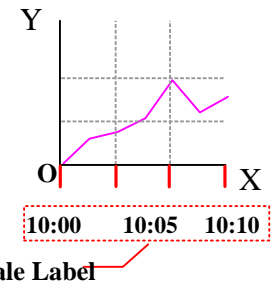
Use Scale Label		
	Label Font	Set the label font
	Integer	The integer number of scale (User cannot adjust it).
	Decimal	The decimal number of scale (User cannot adjust it).
Use Horizontal Axis Time Scale	Trend Curve displays the horizontal scale.	
	Scale Color	Set the vertical scale color.
	Display Scale Frame	Display the scale frame or not.
		
	Time scale interval	The time interval between two time scale point, the unit is sampling circle, for example, if the Time scale interval is 3, the time interval between two scale point is three sampling circles' time. So the displayed scale number depends on the sampling points number and time scale interval.
	Length	Set the length of time scale, the unit is pixel.
Mark each sampling point scale	Mark a scale on each sampling point	
Length	Set the length of each sampling points, the unit is pixel.	
Use Scale Label		
	Label Font	Set the scale label font
	Time	Display and set the time format, there are three formats: HH:MM:SS、HH:MM、HH:MM:SS:MS
Date	Display and set the date format, there are three formats: DD*MM*YY、MM*DD*YY、YY*MM*DD. Separator: /、—、.	
Vertical Axis Scale Reference Channel	Channel	The max/min of vertical axis is based on the max/min of specified channel.

History Data Query

Select “History Data Query” in [History Data Query] of [Trend Graph Component Attribute], then set Query Address and Query Trigger Address to make history data query function for trend graph.

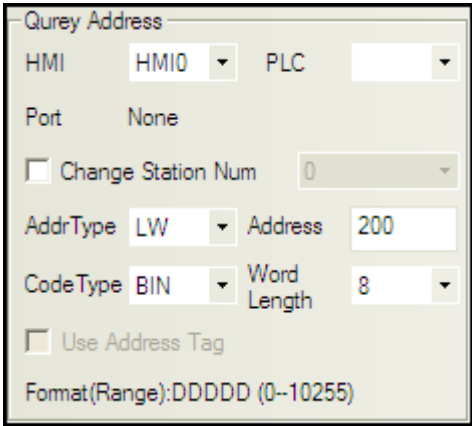
Description of History Data Query attributes	
Query Address	<p>History data query address, the word length is 8.</p> <p>Start Date: Specified address, word length is 2, input year and date in this address.</p> <p>Start Time: Specified address+2, word length is 2, input time (hour, minute and second) in this address.</p> <p>End Date: Specified address+4, word length is 2, input year and date in this address.</p> <p>End Time: Specified address+6, word length is 2, input time (hour, minute and second) in this address.</p> <p>Take the following picture for example, the specified address is LW200, and user wants to query the data between 9:30:40 14th, Aug, 2012 and 14:16:30 15th, Aug, 2012.</p>  <p>So the Specified address are as follows:</p> <p>Start Date: LW200=20120814</p> <p>Start Time: LW202=93040</p> <p>End Date: LW204=20120815</p> <p>End Time: LW206=141630</p>
Query Trigger Address	When the specified address status is on, the trend will trig query function.

Print

If the Open printing option is checked, the trend curve can be printed in real-time.



The real-time printing in Trend Curve only supports micro printer

Description of printing attributes		
Mode	Print per point	The printing is triggered by every sampling point
	Print per page	The printing is triggered when all the sampling points on a whole page is finished
	Print whole	The printing is triggered after all the sampling points on all pages are finished in multiple page trend curves
	Trigger by register	The printing is triggered when the specified register satisfies the setting condition
Paper Width	Set the paper width according to the printer	
Step	The pixel between two small grids	
Vertical axis scale reference channel	Set the standard channel of vertical axis scale. That is to say set the upper limit and lower limit of vertical axis	
Time Mode	Set the display time mode of horizontal axis. Two modes are optional: HH:MM、HH:MM:SS	
Trigger Style	OFF→ON	If chose the Trigger by register in the Mode, the printing will be triggered when specified register changes from OFF to ON
	ON→OFF	If chose the Trigger by register in the Mode, the printing will be triggered when specified register changes from ON to OFF
	OFF↔ON	If chose the Trigger by register in the Mode, the printing will be triggered when specified register changes its state
	OFF→ON(Reset)	If chose the Trigger by register in the Mode, the printing will be triggered when specified register changes from OFF to ON, then the register will be reset to OFF automatically
	ON→OFF(Reset)	If chose the Trigger by register in the Mode, the printing will be triggered when specified register changes from ON to OFF, then the register will be reset to ON automatically
Print axis	The horizontal axis and vertical axis of printing. The line type, line width and axis color can be set	
Print horizontal axis(time)	The display time interval (show time), font size and color can be set. The show time means the display interval between the previous printing time and the next printing time, the unit is sampling points	
Print vertical axis(scale)	Print vertical axis has two forms: Percentage and Sampling value. The font size and color of vertical axis are changeable	

Print baseline	The baseline is the standard line in horizontal direction. Two baselines can be printed at most. The base line value, baseline type, line width and baseline color can be set. The baseline value is suggested not to exceed the limit of standard channel
----------------	--

Print Trigger Line



This function is valid only when the Open Printing is checked

Description of Print Trigger Line Attribute				
Trigger Register	<p>When value of specified register changes, print a trigger line</p>			
Line Type/Width/Color	Set the type, width and color of trigger line			
Print line scale/time	<p>Set the time and scale of trigger line</p>			
	<table border="1"> <tr> <td>Font Size</td> <td>Set the font size of trigger line time and scale font</td> </tr> <tr> <td>Font Color</td> <td>Set the font color of trigger line time and scale font</td> </tr> </table>	Font Size	Set the font size of trigger line time and scale font	Font Color
Font Size	Set the font size of trigger line time and scale font			
Font Color	Set the font color of trigger line time and scale font			
Print state description	Set the comments information of print trigger line			
	<table border="1"> <tr> <td>Trigger Line State Num</td> <td> <p>Set the state number and corresponding value of trigger state description, 1~256 are optional. For example, set the trigger line state Num to 3, the corresponding value are 0, 1, 2. And the value 0 corresponds to description “temperature rise”, the value 1 corresponds to description “temperature unchanged” and value 2 corresponds to description “temperature descend”</p> <p>When the value of specified register is 2, the trigger line and</p> </td> </tr> </table>	Trigger Line State Num	<p>Set the state number and corresponding value of trigger state description, 1~256 are optional. For example, set the trigger line state Num to 3, the corresponding value are 0, 1, 2. And the value 0 corresponds to description “temperature rise”, the value 1 corresponds to description “temperature unchanged” and value 2 corresponds to description “temperature descend”</p> <p>When the value of specified register is 2, the trigger line and</p>	
Trigger Line State Num	<p>Set the state number and corresponding value of trigger state description, 1~256 are optional. For example, set the trigger line state Num to 3, the corresponding value are 0, 1, 2. And the value 0 corresponds to description “temperature rise”, the value 1 corresponds to description “temperature unchanged” and value 2 corresponds to description “temperature descend”</p> <p>When the value of specified register is 2, the trigger line and</p>			

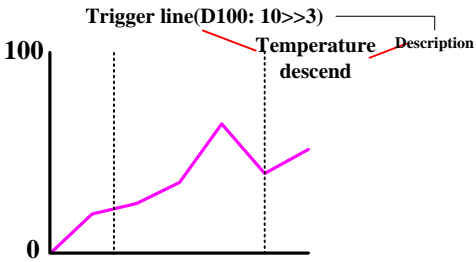
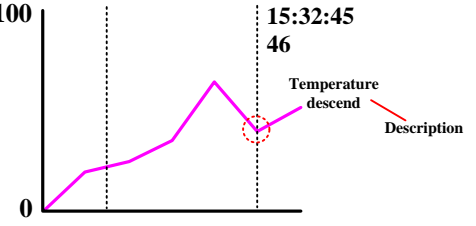
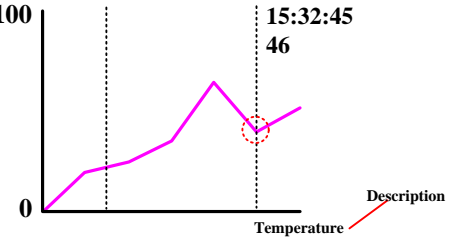
	<p>corresponding description will be printed</p> 
<p>Position of description</p>	<p>Top:</p> 
	<p>Bottom</p> 

【Extend application of Trend Curve】

- View and zoom function

Use the LB9110 to open or close the zoom function. When the LB9110 is ON, the zoom function will be opened.

Zoom out view: In multiple pages trend curve and the page number is more than 1. When LB9110 is ON, double click on the trend curve screen to zoom out the curve.

Zoom in view: When LB9110 is ON, drag the mouse to select a section curve to view the zoomed in curve.

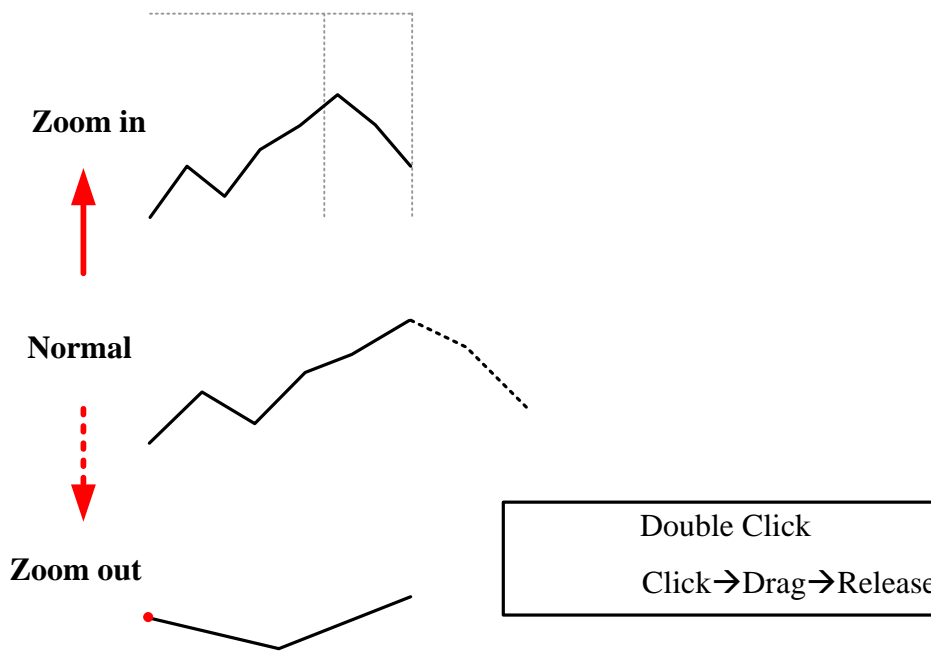

● Cursor function

The system special register LB9111 can enable the cursor function. When LB9111 is on, user can touch and drag the cursor to the data point that user want to select.



The priority of LB9111 is higher than LB9110. If LB9111 is on, the zoom function will be disabling.

● Sampling time and sampling coordinates query function.

When the LB9110 is ON, customer can query the sampling time and sampling coordinates by system registers. Related system registers are as follows :

Description of related system registers		
Special register address	Function	Description
LW9200~LW9205	Display the viewed sampling point time of trend curve	These registers are second, minute, hour, day, month, and year. The Code Type is BIN
LW9210~LW9210+N	Display the coordinates of viewed sampling point	N means the channel number, display the Y coordinates of viewed sampling point in each channel. For example the channel is 2, the LW9210 displays the Y coordinate value of current viewed sampling point in channel 1, and the LW9211 displays the Y coordinate value of current viewed sampling point in channel 2

Take the following picture for example

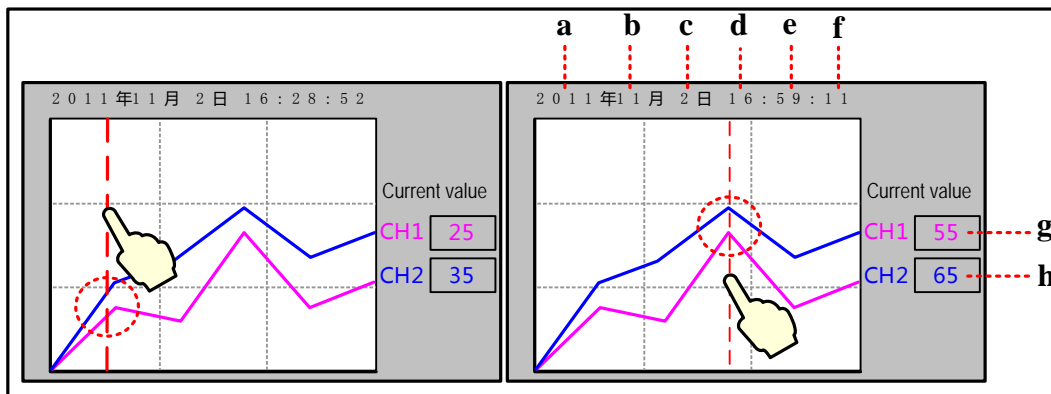

- a. Number Display, LW9205 b. Number Display, LW9204 c. Number Display, LW9203
- d. Number Display, LW9202 e. Number Display, LW9201 f. Number Display, LW9200
- g. Number Display, LW9210 h. Number Display, LW9211

Take MT5320T communicating with SIEMENS S7-200 for example, sample the data in VW0, VW2, VW4 and draw them in a curve, at the same time the sampling points scale can be viewed.

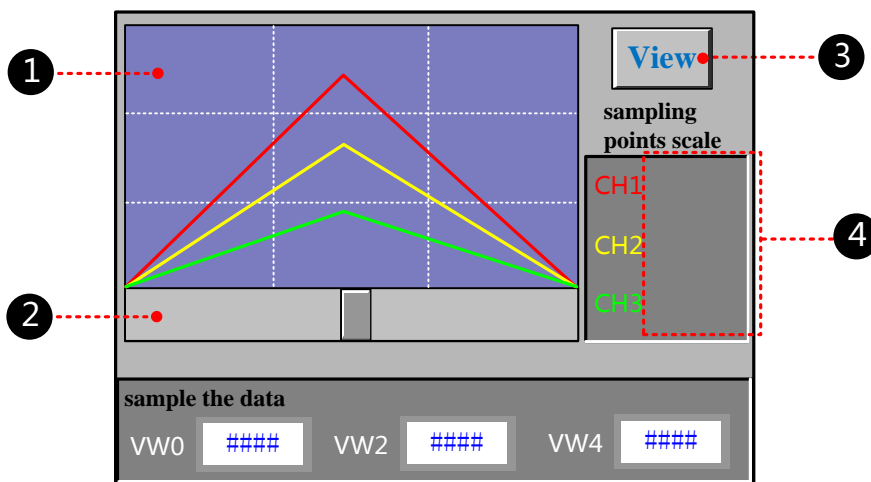

① Build a new Trend Curve component, the component attribute is as followings:

Basic Attribute	
Read Address	VW 0 (PLC register)
Trend Graphics	
Type	Multiple Pages
PageNum	10
Channel	3
SCR0	Checked, address: LW 0 (HMI local register)
Channel	
No. 0	Y Min/Max: 0/500 Color: ■ (Red)
No. 1	Y Min/Max: 0/500 Color: ■ (Yellow)
No. 2	Y Min/Max: 0/500 Color: ■ (Green)

Extended Attributes	
Use Grid	Checked, Lines/Columns: 3/3, Background color: ■(blue-gray), Grid color: □(white), Grid Line Style:- - -

Save Historical Data	
Save to recipe data field	Checked, Start address: 0

② Add a Scroll Bar component to turn page of the historical curve, the setting is as followings:

Basic Attributes	
Write address	LW 0 (HMI local register)

Scroll Bar	
Background Image	Vector Graphics, CONFIRM.vg
Button Image	Vector Graphics, CTRL_BAR001.vg

Scroll Bar Extended Attributes	
Max/Min Value Setting	0/100
Variable Max/Min Value	Unchecked

③ Add a Bit State Switch to zoom the curve, the setting is as follows:

Read/Write Address	LB 9110 (special system register in HMI)
Switch Type	Toggle
Tag	Use Tag checked; 0: View; 1: Cancel
Font	Use Font Graph: Times New Roman, Size 12, Center, Blue.
Graphics	Vector Graphics checked: CONFIRM.vg

④ Add three Number Display components to display the value of current sampling points, the setting is as follows:

Read Address	LW 9210/LW 9211/LW 9212 (special system register in HMI)
--------------	--

The effect is as follows:

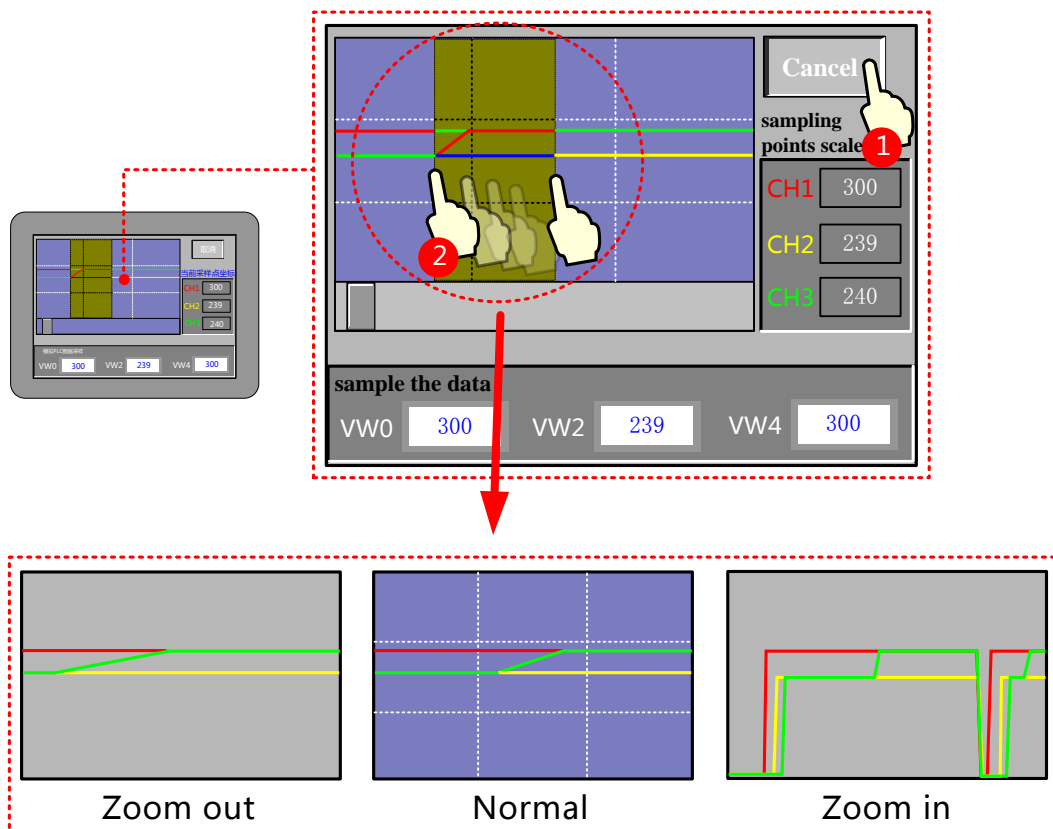

4.6.2 XY Plot

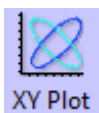

XY Plot read a series of continuous registers from specified HMI local registers or PLC/Controller registers in a period, and plots them in dual axle curve, it can reflect the relationship of two variables.

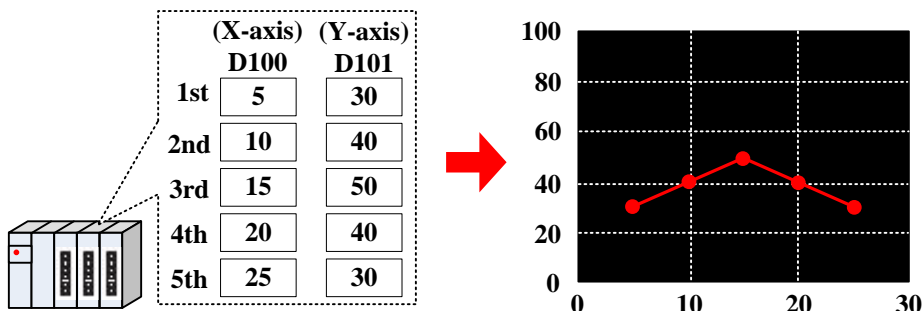

XY Plot

Detail explanation of XY Plot attributes				
Type	Single Page	Only display the data change information of current page, there is no curve extension.		
	Multiple Pages	There is XY plot extension, each channel can be saved, when the XY plot extends, the historical sampling data will not be lost, but save in the buffer area.		
Attributes	Standard	Invalid	Track	Invalid

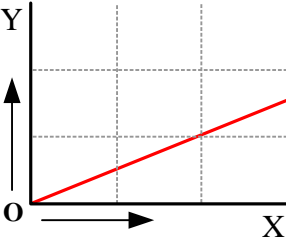
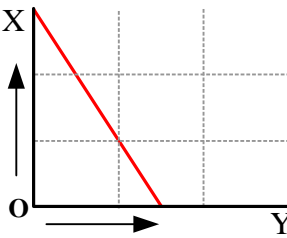
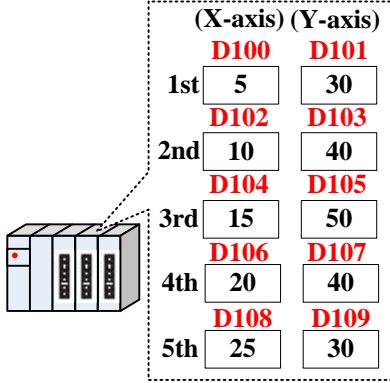
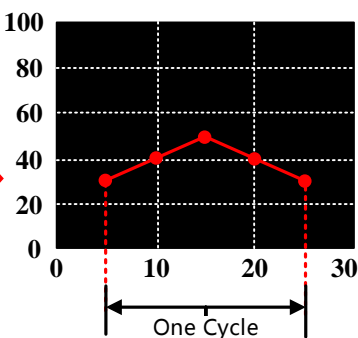
	Trend	Horizontal		Vertical																															
Sampling Method	Time Sampling	Sample data periodically.																																	
	OFF→ON trigger sampling	When specified register changes from OFF to ON, then trigger the sampling.																																	
	ON→OFF trigger sampling	When specified register changes from ON to OFF, then trigger the sampling.																																	
	OFF↔NO trigger sampling	When specified register changes its state, then trigger the sampling.																																	
	OFF→ON reset trigger sampling	When specified register changes from OFF to ON, then trigger the sampling. The specified register will be reset automatically after being triggered.																																	
	ON→OFF reset trigger sampling	When specified register changes from ON to OFF, then trigger the sampling. The specified register will be reset automatically after being triggered.																																	
Cycle	The time interval of the two pages or two sampling points. The unit can be s or 100ms.																																		
XY Plot Type	Standard	<p>Sampling multiple points every time or in each period, with X and Y components. The register number is related to the channel number and sampling number. For example, there is m channels and n sampling points, that is to say, the register number is m*n*2.</p> <div style="display: flex; align-items: center;">  <div style="margin-left: 20px;"> <p>(X-axis) (Y-axis)</p> <table border="1" style="border-collapse: collapse; text-align: center;"> <tr> <td></td> <td>D100</td> <td>D101</td> </tr> <tr> <td>1st</td> <td>5</td> <td>30</td> </tr> <tr> <td></td> <td>D102</td> <td>D103</td> </tr> <tr> <td>2nd</td> <td>10</td> <td>40</td> </tr> <tr> <td></td> <td>D104</td> <td>D105</td> </tr> <tr> <td>3rd</td> <td>15</td> <td>50</td> </tr> <tr> <td></td> <td>D106</td> <td>D107</td> </tr> <tr> <td>4th</td> <td>20</td> <td>40</td> </tr> <tr> <td></td> <td>D108</td> <td>D109</td> </tr> <tr> <td>5th</td> <td>25</td> <td>30</td> </tr> </table> </div>  </div> <p>Example, suppose the Read Address is D100, and there is 1 channel, 5 sampling points in each page; so this XY plot will take 10 registers. They are D100, D101, ..., D109 which corresponding to the X11, Y11, X12, Y12, ..., X15, Y15.</p>					D100	D101	1st	5	30		D102	D103	2nd	10	40		D104	D105	3rd	15	50		D106	D107	4th	20	40		D108	D109	5th	25	30
		D100	D101																																
1st	5	30																																	
	D102	D103																																	
2nd	10	40																																	
	D104	D105																																	
3rd	15	50																																	
	D106	D107																																	
4th	20	40																																	
	D108	D109																																	
5th	25	30																																	
Track	Sampling one point each time, with X and Y components. The register number is related to the channel number. For example, the channel number is m, sampling points is n, so																																		

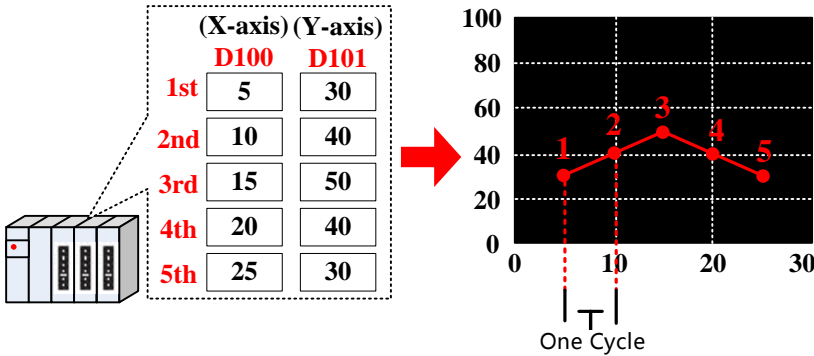
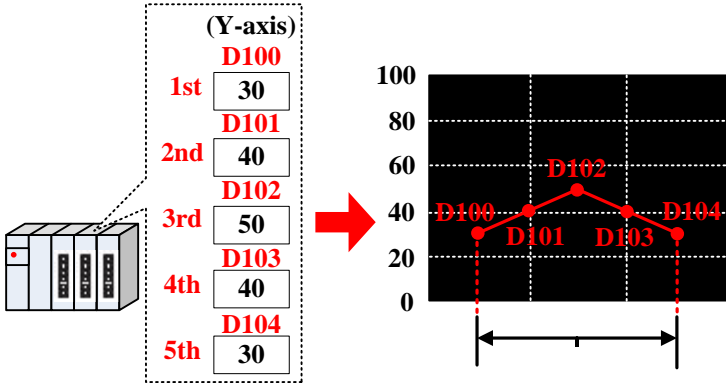
	<p>the register number is $m*2$.</p>  <p>Example, suppose the Read Address is D100, and there is 1 channel, 5 sampling points in each page; so this XY plot will take 2 registers. They are D100 and D101 which corresponding to the X1 and Y1.</p>
Trend	<p>Sampling multiple points every time or in each period, with Y components, but no X components. The register number is related to the channel number and sampling number. For example, there is m channels and n sampling points, that is to say, the register number is $m*n$.</p>  <p>Example, suppose the Read Address is D100, and there is 1 channel, 5 sampling points in each page; so this XY plot will take 5 registers. They are D100, D101, ..., D104 which corresponding to the Y11, Y12, ... Y15.</p>
Sampling Points	The sampling points displayed on each page
PageNum	This option is valid only when the Multiple Pages is chosen.
Channel	Displayed curve number.
Trigger Register Setting	This option is valid when use the trigger sampling in the Sample Methods. Take the following picture for example, set the LB100 (HMI local register) as the trigger register, the sampling will be triggered when the state in LB100 satisfies the setting in Sampling Method.

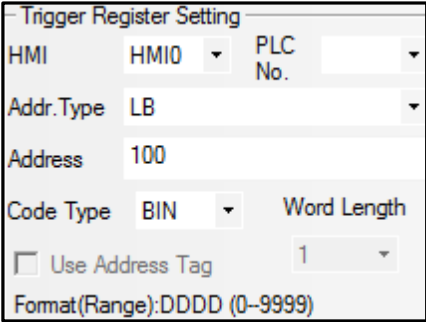
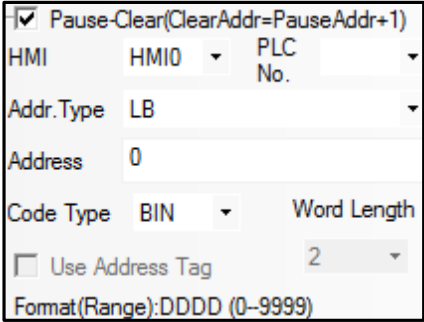
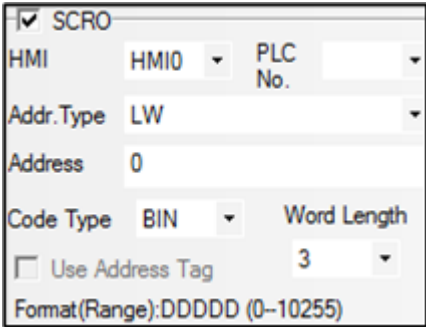
	
<p>Pause/Clear</p>	<p>Set the register that controls the Pause and Clear function, the default word length is 2, the [set register] controls the Pause, and [set register+1] controls the Clear. The Pause function only stops the change of curve, but not stops the sampling. The Clear function clears the curve displayed on the XY plot. Take the following picture for example, set LB0 (HMI local register) as the register to control Pause and Clear. When LB0 is ON, the screen on XY Plot will stop refreshing; when LB0 is OFF, the screen on XY Plot will continue to display the change of curve. When LB1 is ON, the curve on XY Plot will be cleared.</p> 
<p>SCRO</p>	<p>Set the register to turn page of multiple pages of XY Plot, the default word length is 3. This option is valid when the Multiple Pages is chosen. Use this function to scroll the multiple pages XY plot, and can be used with the Scroll Bar. For details, refer to [Advanced Part 4.16.3 Scroll Bar]</p> <p>Take the following picture for example, the specified register is LW0 (HMI local register), so the LW0 is the current index value of scroll bar, LW1 is start index value of scroll bar, LW2 is the maximum index value of scroll bar.</p> 
<p>Time</p>	<p>Use this function to save the start time and end time of current page. This function is valid when the “Save Time” is checked. The default word length is 12. Take the following picture for example, the specified address that is used to save time is LW70(HMI local register), the start time (Second, Minute, Hour, Day,</p>

Month and Year) of current page are LW70, LW71, LW72, LW73, LW74 and LW75. the end time (Second, Minute, Hour, Day, Month and Year) of current page are LW76, LW77, LW78, LW79, LW80 and LW81.

<input checked="" type="checkbox"/> Time	
HMI	HMI0 PLC No.
Addr.Type	LW
Address	70
Code Type	BIN Word Length
<input type="checkbox"/> Use Address Tag	12
Format(Range):DDDDD (0-10255)	

4.6.3 Oscillograph

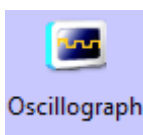

The function of Oscillograph component is similar to the Trend Curve. They read continuous registers from specified HMI local registers or PLC/Controller registers periodically, and plots them in single axis curve.

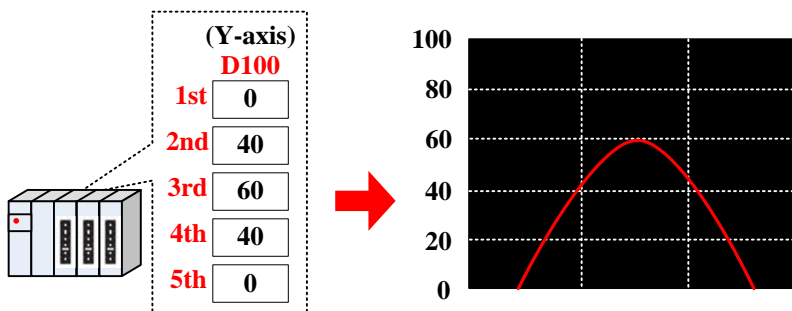

Oscillograph

Detail explanation of Oscillograph attributes

Type	Single page	Only display the data change information of current page, there is no curve extension.		
	Multiple Pages	There is XY plot extension, each channel can be saved, when the XY plot extends, the historical sampling data will not be lost, but save in the buffer area.		
Property	The direction that Oscillograph curve starts.			
	Start from Left		Start from Right	

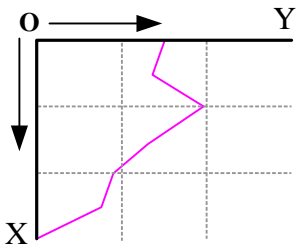
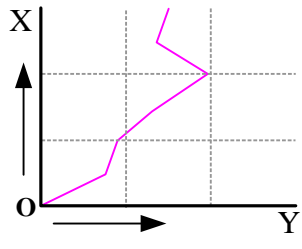
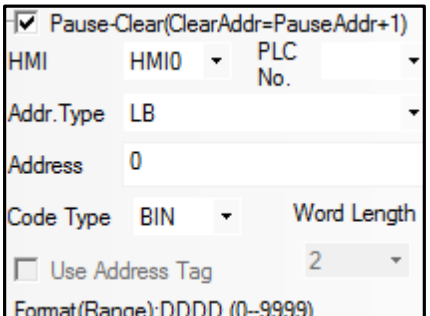
	<p>Start from Top</p> 	<p>Start from bottom</p> 
Cycle	The time interval of every 2 sampling points. The unit can be s or 100ms.	
Sampling Rate	When use the rate sampling, the Oscillograph reads [Sampling Rate number] groups data each time. For example, the Read Address is LW10 (HMI local register), Sampling Rate is 2, Channel is 3, so the read address is LW10~LW15. The address distribution is as follows: three channels' data of the first group are saved in LW10, LW11 and LW12; three channels' data of the second group are saved in LW13, LW14, and LW15. If the sampling cycle is 1s, the Oscillograph reads these two groups data every second. The rate sampling makes the curve more smooth and accurate	
Sampling points	Sampling points number displayed on each page	
PageNum	This option is valid when the Multiple Pages is checked	
Channel	Displayed curve number	
Pause/Clear	<p>Set the register that controls the Pause and Clear function, the default word length is 2, the [set register] controls the Pause, and [set register+1] controls the Clear. The Pause function only stops the change of curve, but not stops the sampling. The Clear function clears the curve displayed on the Oscillograph. Take the following picture for example, set LB0 (HMI local register) as the register to control Pause and Clear. When LB0 is ON, the screen on Oscillograph will stop refreshing; when LB0 is OFF, the screen on Oscillograph will continue to display the change of curve. When LB1 is ON, the curve on Oscillograph will be cleared.</p> 	
SCRO	<p>Set the register to turn page of multiple pages of Oscillograph, the default word length is 3. This option is valid when the Multiple Pages is chosen. Use this function to scroll the multiple pages Oscillograph, and can be used with the Scroll Bar. For details, refer to [Advanced Part 4.16.3 Scroll Bar]</p> <p>Take the following picture for example, the specified register is LW0 (HMI local register), so the LW0 is the current index value of scroll bar, LW1 is start index value of scroll bar, LW2 is the maximum index</p>	

value of scroll bar.

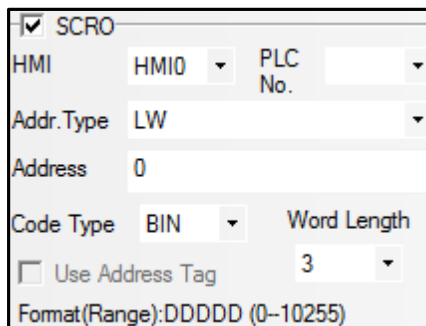

Time

Use this function to save the start time and end time of current page. This function is valid when the “Save Time” is checked. The default word length is 12. Take the following picture for example, the specified address that is used to save time is LW70(HMI local register), the start time (Second, Minute, Hour, Day, Month and Year) of current page are LW70, LW71, LW72, LW73, LW74 and LW75. the end time (Second, Minute, Hour, Day, Month and Year) of current page are LW76, LW77, LW78, LW79, LW80 and LW81.

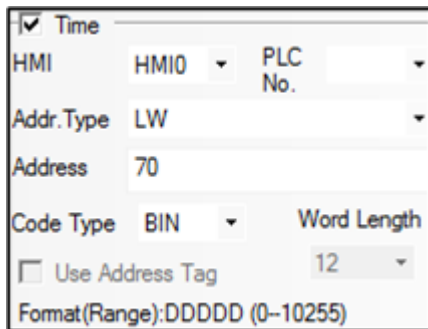

4.6.4 Meter

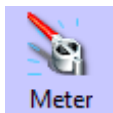

Meter component displays the data of HMI or PLC/Controller in instrument chart.

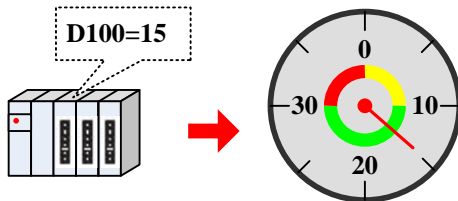

Meter Component

Detail explanation of Meter attributes

Dial Style	Pie, Circularity(point up), Circularity(point down)
------------	---

Hand color	Chose the color of the meter hand
Length	Set the length of the meter hand, the maximum is the radius of the actual circle
Width	Set the width of meter hand
Hand Style	Chose the style of meter hand
Scale color	Chose the color of meter scale
Show Scale Frame	<p>Set to display the scale frame or not</p>
The Number of Main Scale	Set the number of main scale, 0~50 are optional
The Length of Main Scale	Set the length of main scale, the maximum cannot exceed the radius length of actual circle
The Number of Minor Scale	Set the number of minor scale, 0~10 are optional
The Length of Minor Scale	Set the length of main scale, the maximum cannot exceed the radius length of actual circle
Use Scale Tag	Set to display the scale tag or not
Tag Font	Click the Tag Font to set the font of tag
Integer	The integer number of scale tag (Can not be set, it will change according to the maximum of meter)
Decimal	Set the decimal number of the scale tag, 0~8 are optional
Use Dial Axis	Checked to set the axis size and color
Axis Width	Set the size of meter axis, the maximum cannot exceed the radius length of actual circle
Axis Color	Set the color of meter axis

Meter Component Extended Attribute

Explanations of Meter Extended Attributes	
Maximum/Minimum	Set the display range of meter.

Variable Min/Max	Set the registers where variable Minimum and Maximum are stored.
Upper Limit/Lower Limit	Set the color of the Upper/Lower Limit.
Fan Thickness	Set the thickness of the circle color block. The maximum can not exceed the radius of meter circle, and should be equal to or smaller than the Fan External Radius.
Fan External Radius	Set the radius of circle color block. The maximum can not exceed the radius of meter circle, and should be equal to or larger than the Fan External Radius.
Lower Limit/Upper Limit	Set the alarm range of the meter component.
Variable Lower/Upper Limit	Set the register where the alarm range be stored.

4.6.5 Bar Picture

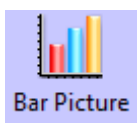

Bar Picture displays the data in HMI local register or PLC/Controller register in percentage of bar picture , that is to say the bar picture displays the percentage of actual value compared to the set maximum/minimum value.

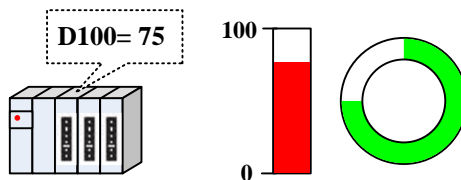

Bar Picture does not support the float data format

Bar Picture

Detail Explanation of Bar Picture Attributes

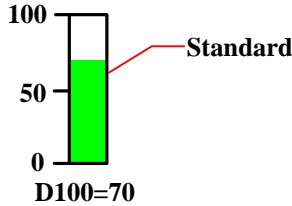
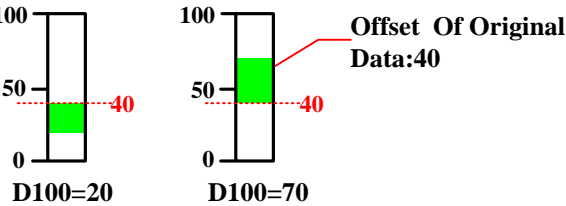
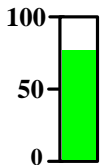
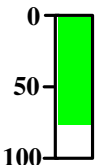
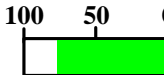
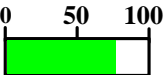
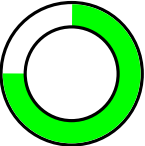
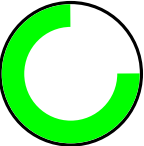
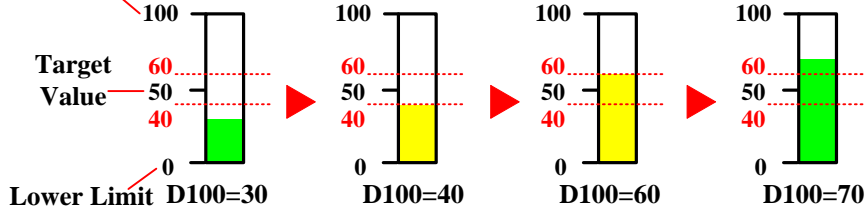

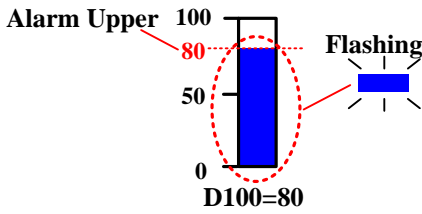
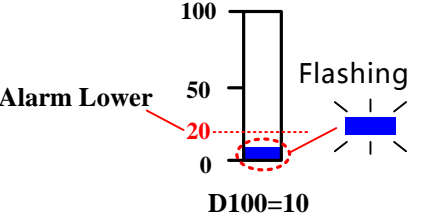
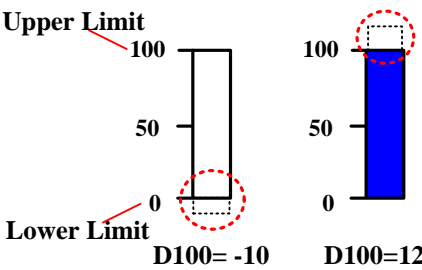
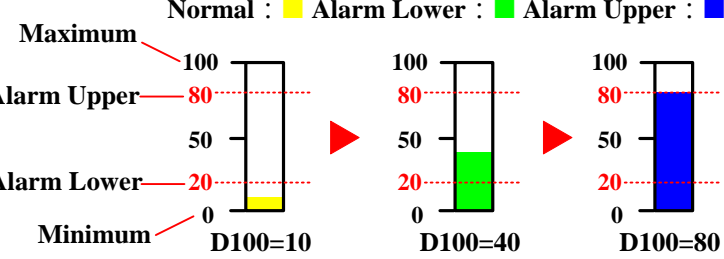

Bar Type	Standard	<p>Display the percentage of actual value compared to the set maximum/minimum value in bar picture.</p> 		
	Offset	<p>Display the offset value of actual value compared to the original data in bar picture.</p> 		
Bar Shape	Art direction			
Rectangle	Up	Bottom	Left	Right
				
Circle	Clockwise		Counter clockwise	
				
Target Value	<p>If the value in specified register is in the permissible range, the bar picture displays specified color in filling area.</p> <p>Target value : 50 Permissible error : 10 Color : Yellow</p> <p>Upper Limit Target Value Lower Limit</p> 			

Diameter of Fan	Set the diameter of fan when the Bar Shape is Circle, the unit is pixel.
Start Angle	Set the start angle of fan when the Bar Shape is Circle.
End Angle	Set the end angle of fan when the Bar Shape is Circle.
Color	Set the color for Normal state, Upper/Lower Limit, Frame and Background.
Over Upper Limit Flashing	<p>When the value in specified register exceeds the Alarm Upper, the filling area in bar picture flashes.</p> 
Over Lower Limit Flashing	<p>When the value in specified register exceeds the Alarm Lower, the filling area in bar picture flashes.</p> 
Maximum/Minimum	<p>Set the upper/lower limit of bar picture.</p>  <p>The percentage of filling area of Bar Picture can be calculated by the following formula: The percentage of filling area of Bar Picture= (Value in specified register-[Minimum])/([Maximum]-[Minimum])*100%</p>
Variable Min/Max	The Maximum and Minimum are read from specified registers.
Alarm Upper/Lower	<p>Set the alarm range, when the value in specified registered is larger than Alarm Upper or smaller than Alarm Lower, the filling area of bar picture displays the specified Alarm Color.</p> <p>Normal : ■ Alarm Lower : ■ Alarm Upper : ■</p> 
Variable Alarm	The Variable Alarm Upper/Lower are read from specified registers.

Upper/Lower	
-------------	--

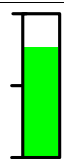
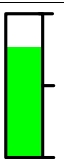
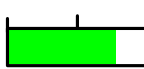

Detail Explanation of Scale Attributes

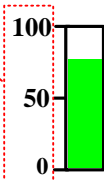
Use Scale	Scale Color	Set the scale color			
	Show Scale Frame	Set to display scale frame or not.			
		 Display		 Not Display	
	The Number of Main Scale	Set the number of main scale			
	The Length of Main Scale	Set the length of main scale, unit is pixel.			
	The Number of Minor Scale	Set the number of minor scale			
	The Length of Minor Scale	Set the length of minor scale, unit is pixel.			
Scale Display Position		Left	Right	Up	Bottom
					
Use Scale Tag		 Scale Tag			
	Tag Font	Set the font of tag			
	Integer	Integer of scale cannot be set by user.			
	Decimal	Decimal of scale, can be set by user.			

4.7 Alarm Component

Alarm component is used to display user alarm or user event information. Inco HMIware provides components of event display, historical event display, event bar, alarm display and alarm bar for displaying alarm information.



- 1.The event information displaying in components of event display, historical event display, event bar must be preset in **【Event Information Logon】** in project database.
2. The alarm information displaying in components of alarm display, alarm bar must be preset in **【Alarm Information Logon】** in project database.
3. Alarm information can't be saved, and alarm display component can only display the unrecovered alarm information.

4. Event information can be saved, and event display component can display both unrecovered event information and recovered event information.

- Related attribute of event information setting
 - Event information storage

Set the storage of event information in **【HMI Attribute】** — **【Historical Events Storage】** .

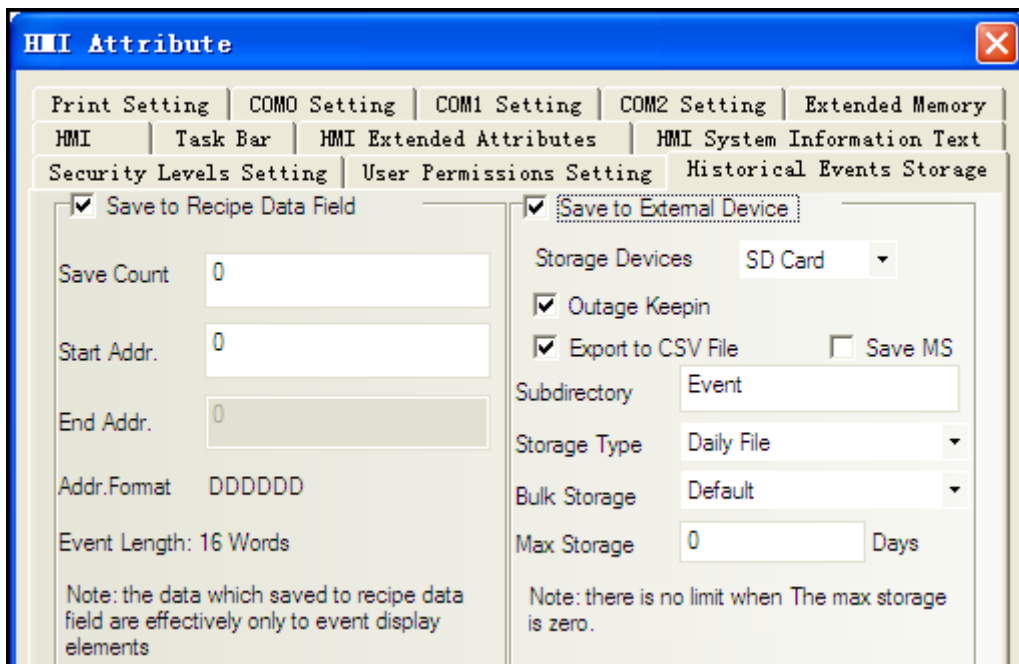

(1) Save to Recipe Data Field

It is used to save event information to recipe memory of HMI (RW register).



- 1."Save Count" must be greater than 0.If "Save Count" is 0, then system won't save event to recipe data field.
- 2."Start Addr." can be user-defined. The length of one event information is 16 words. System will set "End Addr." Automatically according to "Save Count".
3. Event information which saves to recipe data field cannot display in historical event display component.

(2) Save to External Device

It is used to save event information to external device.

When "Storage Type" is set as "Daily File", then the event information will save to path "event/Subdirectory name/yyyymmdd.csv".When "Storage Type" is set as "Single File", then the event information will save to path "event/Subdirectory name/ Subdirectory name.csv". (Therein, yyyyymmdd is event execution date such as 20110101)



1. Only the HMI with USB HOST or SD Card support saving to external device.
2. Only the event information which is saved to external device can query by date or order sequence and display in “Historical Event Display” component.
- 3.Event information can save to recipe data field and external device at the same time.

[For details about historical event storage, refer to \[Advanced Part 6.1.7 Historical Events Storage\]](#)

➤ Event information clear

There are four ways to clear event information which displaying in event display component.

- (1) Set LW10015 as 0 and restart HMI.

This way is used to clear all the event information which are saved in recipe data field.

- (2) Tick **【Clear History Event Data】** in **【EVDownload】** when downloading project. The event information will be clear after downloading.

This way is used to clear all the event information which are saved in recipe data field and external device.

- (3) Use **【Clear Event】** function in function key.

This way is used to clear all the event information which are saved in recipe data field.

- (4) Use **【Clear History Event】** function in **【KHManager】** .

This way is used to clear all the event information which are saved in recipe data field and external device.

➤ System Scroll Bar Width setting

When the information in Event Display component cannot totally display horizontally, then system will provide scroll bar automatically.



The width of system scroll bar can be set in **【HMI Attribute】**—**【HMI Extended Attributes】**, the range is 20~120 (Pixel).

4.7.1 Event Display

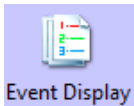

Event display is used to display event information logon in “Event Information Logon”. The displaying events will be sorted by triggered time.

Logon

No.	Type	HMI No.	Address	Info.	Address	Trigger	Condition	Content
0	0	1	HMI0:PLC0:	D:0			>100	Abnormal Temp.

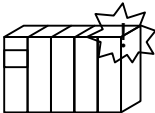

Display

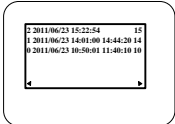

2 2011/06/23 15:22:54 15:25:13 Abnormal Temp.

1 2011/06/23 14:01:00 14:44:20 14:44:23 Abnormal Temp.

0 2011/06/23 10:50:01 11:40:10 10:54:20 Abnormal Temp.

【Read Address】 in Event Display component is used to scroll the event information(Up or down).

Event Information

Related setting descriptions for event information

Display Type Range	This event display component can only display the event within this type range. The event type is set in “Event Information Logon”.		
Row Space	The space between two rows or two Columns.		
Acknowledge Type	Set the acknowledge method for triggered event. Click or Double Click.		
Color	Acknowledge Color	The color of event information after affirming.	
	Back to Normal Color	The color of event information after event back to normal.	
	Select Area Color	The color of dotted line for indicating user information.	
Format	The format of event information. All the format information display in front of event information.		
	<p>2 2011/06/23 15:22:54 15:25:13 Abnormal Temp.</p> <p>1 2011/06/23 14:01:00 14:44:20 14:44:23 Abnormal Temp.</p> <p>0 2011/06/23 10:50:01 11:40:10 10:54:20 Abnormal Temp.</p>		
	Sequence No.	Trig Time	
	Trig Date	Acknowledge Time	
		Return to Normal Time	Event Information
Sequence No.	Sequence No. of events, it starts from 0.		
Event Trig Time	The time when event triggered		
Acknowledge Time	The time when event acknowledged		
Return to Normal Time	The time when event returns to normal		
Extended Time Format (D/H:M)	Time format is Day/Hour: Minute		

Short Time Format (H:M)	Time format is Hour: Minute
Standard Time Format (H:M:S)	Time format is Hour:Minute:Second
Precise Time Format (H:M:S:MS)	Time format is Hour:Minute:Second:Millisecond
Extended Date Format (Y/M/D)	Date format is Year/Month/Day
Event Trig Date (M/D)	Date format is Month/Day
Time Ascending Order Display	Tick it indicate that the events display by ascending order of sequence No. and time. Or the event display by descending order of sequence No. and time.
Only show the Event which doesn't recover	Tick it to only show the event which doesn't recover. Or it will display all the events.

【Example】 Take the serial communication between MT5320T and SIEMENS S7-200 for example, when the temperature is higher than 80℃ or the pressure is higher than 120Mpa, then the HMI will display alarm and output buzzer alarm, then it can display and query historical event record.

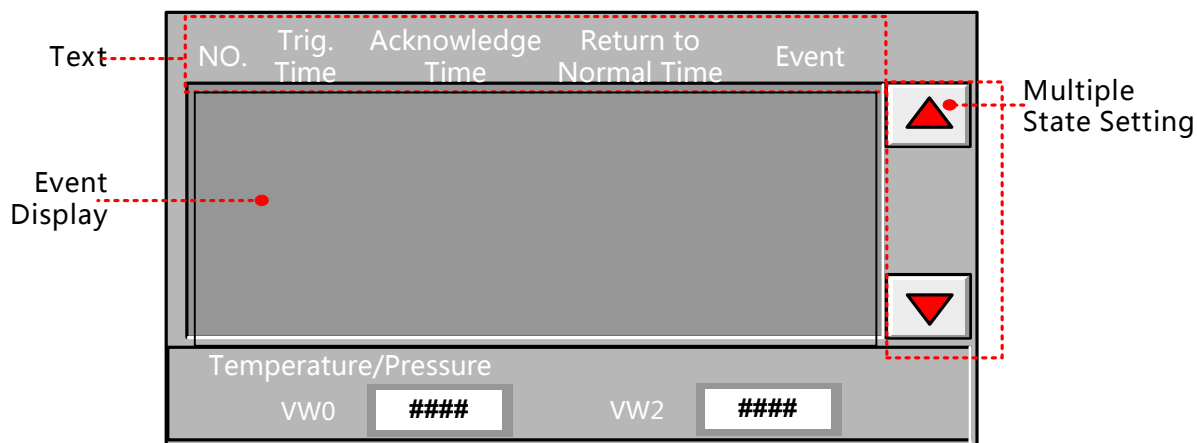

❶ Create new project [Event], and then add two windows Frame10 and Frame11 which are used for temperature alarm and pressure alarm. Set the attributes as follows:

Name	Alarm window_1/Alarm window_2
X/Y	80/80
Width/Height	200/100
Use Background Color	Tick, Fill Color: ■ (Yellow)
Frame	Width: 2 Frame Color: ■ (Gray-50)
Pop Window Type	Monopoly: tick

❷ Add two texts and function keys in Frame10 and Frame11, and then draw a alarm symbol.

Set attributes of text as follows:

Content	Abnormal Temp./Abnormal Pressure
Font Type	Vector Font
Font Attribute	Font: Arial Black Size: 12 Color: ■ (Red)

Set attributes of function key as follows :

Switch Window	Close window
Graphics	No use

Set the size of function key to the same as the size of window.

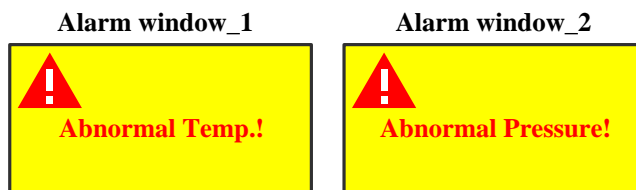

③ Add event information in **【Project Database】 — 【Event Information Logon】** .Set event information as follows:

Temperature Alarm:

Data Type	Word
Address	VW 0(PLC register)
Condition	>80
Pop-up window	Tick,[10: Alarm window_1]
Use buzzer	Tick,1 second
Text	Abnormal Temp.!

Pressure Alarm:

Data Type	Word
Address	VW 2(PLC register)
Condition	>120
Pop-up window	Tick, [10: Alarm window_2]
Use buzzer	Tick,1 second
Text	Abnormal Pressure!

④ Add “Event Display” component in Frame0,set its attribute as follows: :

Read Address	LW 0 (HMI local register)
Format	Tick Sequence No., Event Trig. Time, Acknowledge Time, Return to Normal Time, Standard Time Format (H:M:S).

Add two “Multiple State Setting” components in Frame0, and set their attributes as follows:

Write Address	LW 0 (HMI local register)
Setting Mode	Sub/Add
Subtrahend/Addend	1/1
Lower/Upper	0/100
Graphics	Use vector graphics, Button6-27.vg/Button6-28.vg

Historical events storage setting

Open **【HMI Attribute】** — **【Historical Events Storage】** ,tick **【Save to Recipe Data Field】** , set **【Save Count】** to 100, set **【Start Addr.】** as 0,means events will be saved in the registers start from RW0.

When the value of VW0 is larger than 80□ :

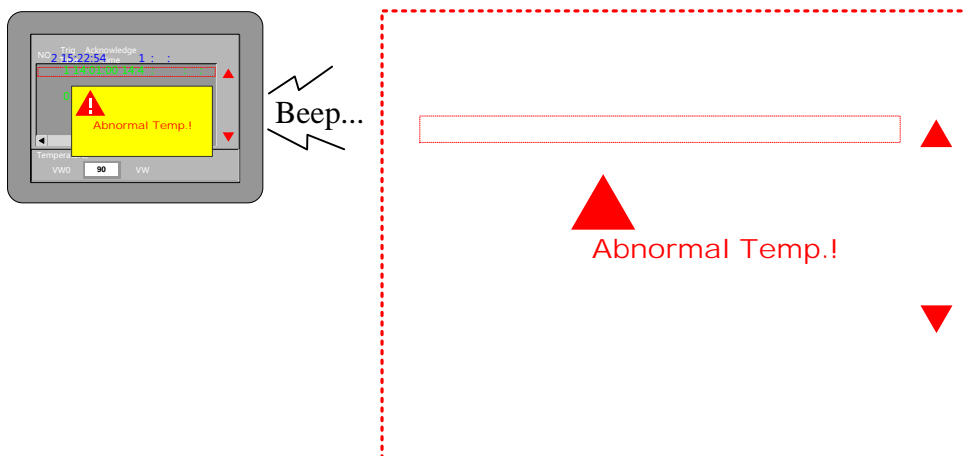

4.7.2 Historical Event Display

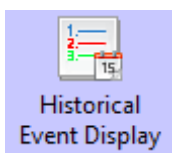

Historical event display is used to query the triggered historical event information, which are added in “Event Information Logon”, and display them as form format.



1. **【Read Address】** in “Historical Event Display” component is used to query historical event. Word length is 2 by default.
2. It must tick the option “Save to External Device” in **【HMI Attribute】** — **【Historical Event Storage】** and set the subdirectory when using “Historical Event Display” component.

Table Display Attribute

Descriptions for Table Display Attribute		
Table Display	Time	It is used to set whether display time for trigger, acknowledge and recovery events and time format. Therein, YY means year, MM means month, DD means day.
	Date	It is used to set whether display date for trigger, acknowledge and recovery events and time format. Therein, YY means year, MM means month, DD means day.
	Separator	Choose the separator for date, there are three format options. Such as 11/06/24.
	Sequence No.	Set whether display the sequence no. of event information
	Ascending Order	Selecting it indicates the event information is sequenced by ascending order according to time. Or it is sequenced by descending order.
Background Setting	Set the border width and the color of background, title bar and border of Historical Event Display	

	component.	
Historical Event Query	Query by File Order	<p>If selecting it, then when the value of the specific register is 0,it means to display the historical event information of today or the latest day. When the value is 1,it means to display the historical event information of the previous day. And by parity of reasoning.</p> <p>For example, there are two files in extended memory, 20110621.csv and 20110624.csv.When the value of the specific register is 0, then it will display the historical event in Jun.24th, 2011.When the value is 1, then it will display the events in Jun.21st, 2011.</p>
	Query by Date	<p>If selecting it, then when input the date in the specific register, it will display the historical event in this day. The format of inputting date is yyyyymmdd (yyyy means year, mm means month, dd means day).</p> <p>For example, when input 20110624 in the specific register, then it will display the historical events in Jun.24th, 2011.</p>
Separator Setting	<p>Set the color, line style, line width of separator line, and row space and column space. The unit of row space and column space is pixel.</p> <p>Tick “Horizontal Line” to display horizontal separator line. Tick “Vertical Line” to display vertical separator line.</p>	
Status display	Trigger	Set the status information which is used to display in status column of the table when event is triggered. It is set as 0 by default.
	Confirm	Set the status information which is used to display in status column of the table when event is confirmed. It is set as 1 by default.
	Resume	Set the status information used to display in status column of the table when event is resumed. It is set as 2 by default.
Title Bar Setting	Set the name and font attribute of title bar.	

4.7.3 Event Bar



Event Bar is used to display and roll the triggered information from right to left which is already set in “Event Information Logon”.

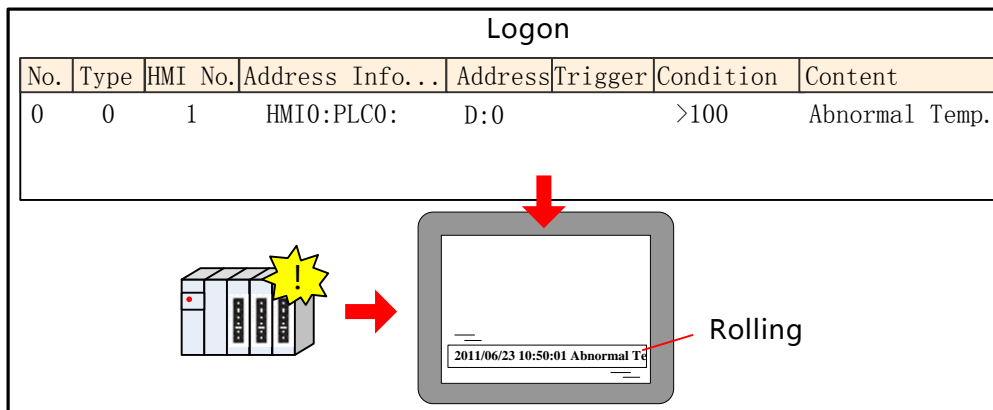

Event Information

Attribute Descriptions of Event Information

Display Type Range	Set type range of event information, only this type range will display in the Event Bar. The type of event information is set in "Event Information Logon".	
Moving Step	Set the moving step of event information. The unit is pixel. The bigger the value, the faster the moving speed.	
Moving Rate	Set the interval time of moving the event information. The unit is 100ms. The bigger the value, the slower the moving speed.	
Gap Space	Set the space between two events ranging from 1-7 pixel.	
Format	Set the display format of event information. All the format information will display in front of event information.	
	<p>2011/06/23 15:22:54 Abnormal Temp.</p> <p>Trig. Date Trig. Time Event Information</p>	
	Event Trig. Time	The time when event is triggered.
	Extended Time Format (D/H:M)	Time format is Day/Hour: Minute.
	Short Time Format (H:M)	Time format is Hour: Minute.
	Standard Time Format (H:M:S)	Time format is Hour: Minute: Second.
	Precise Time Format (H:M:S:MS)	Time format is Hour: Minute: Second: Millisecond.
	Extended Date Format (Y/M/D)	Date format is Year/Month/Day.
Event Trig. Date(M/D)	Date format is Month/Day.	
Time Ascending Order Display	Selecting it to display the event information by time ascending order. For example, 2011/06/23 15:22:54 Event 1 2011/06/23 16:20:40	

	Event 2 Cancel it to display the event information by time descending order. For example, 2011/06/23 16:20:40 Event 2 2011/06/23 15:22:54 Event 1
--	---

4.7.4 Alarm Display

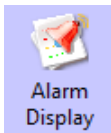

Alarm Display component is used to display the triggered alarm information which is already set in “Alarm Information Logon”. The alarm information will not remove until the alarm condition is cleared.

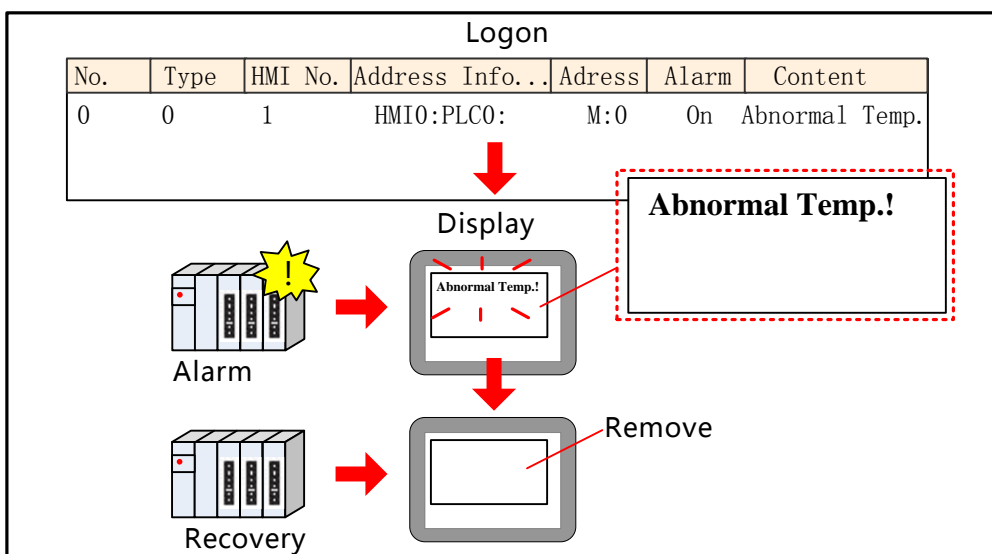

【Read Address】 in Alarm Display component is used to roll the alarm information(Upward or downward)

Alarm Display

Attribute Descriptions for Alarm Display	
Row Space	Set the interval between two alarm information. The unit is pixel.
Column Space	Set the interval between two characters or words in the alarm information. The unit is pixel.
Display Type Range	Set the type range of alarm information, only this type range will display in the alarm display. The type of alarm information is set in “Alarm Information Logon”.

4.7.5 Alarm Bar

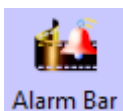

Alarm Bar is used to display and roll the triggered alarm information which is already set in “Alarm Information Logon”.

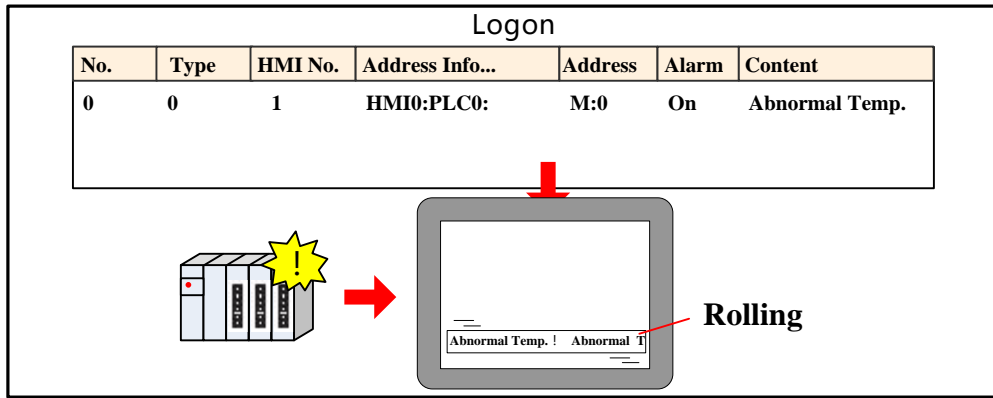

Alarm Bar

Attribute Descriptions of Alarm Bar

Moving Step	Set the moving step of alarm information. The unit is pixel. The bigger the value, the faster the moving speed.
Moving Rate	Set the interval time of moving the alarm information. The unit is 100ms. The bigger the value, the slower the moving speed.
Display Type Range	Set type range of alarm information, only this type range will display in the Alarm Bar. The type of alarm information is set in “Alarm Information Logon”.

4.8 Window Component

Kinco HMIware provides two window components, Direct Window and Indirect Window, which are used for popup window.

The main differences between the two window components and **【Popup Window】** in Function Key are as follows:

Component	Read Address	Control Method	Window No.
Direct Window	Bit	According to the state of Read Address	Specify in the attribute
Indirect Window	Word	According to the value of Read Address	According to the value of Read Address
Function Key	None	Touch	Specify in the attribute

4.8.1 Direct Window



Direct Window is used to define a display area and display the specific window in this area according to the state of Read Address.

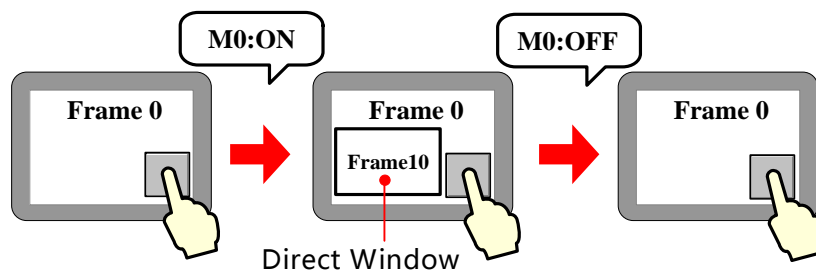



1. Direct Window's open or close depends on the state of Read Address, it means that it will popup window when the state of Read Address is ON, and close window when the state is OFF.
2. Generally the size of Direct Window should be set the same as the size of specific popup window.
3. There is no limit for the quantity of Direct Window.

Direct Window

Attribute Descriptions of Direct Window

	Attribute Descriptions of Direct Window
Frame ID	Specify the window which will display in the display area of Direct Window
Variable Coordinates	<p>Select it to set the coordinates of Direct Window as variable. [Address] is used for X coordinate,[Address+1] is used for Y coordinate.</p> <p>Origin (0,0) (X,Y) (0,0) (80,10)</p> <p>D100: 0 D101: 0</p> <p>D100: 80 D101: 10</p> <p>Please input password: *****</p> <p>Please input password: *****</p>
Display	<p>Cancel it to set the coordinates of Direct Window as constant.</p>



Direct Window can be closed by the "Close Window" function in Function Key

4.8.2 Indirect Window



Indirect Window is used to define a display area and display the window whose number is the same as the value of Read Address.

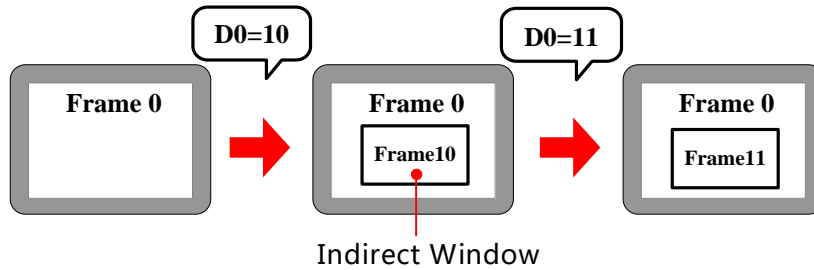

1. It will close window when the value of the register is 0. And it will popup window 0 when the value is -1.
2. Generally the size of Indirect Window should be set the same as the size of specific popup window.
3. There is no limit for the quantity of Indirect Window.

Indirect Window

Explanation of Indirect Window attributes

Select it to set the coordinates of Indirect Window as variable. [Address] is used for X coordinate, [Address+1] is used for Y coordinate.

Variable Display
Coordinates

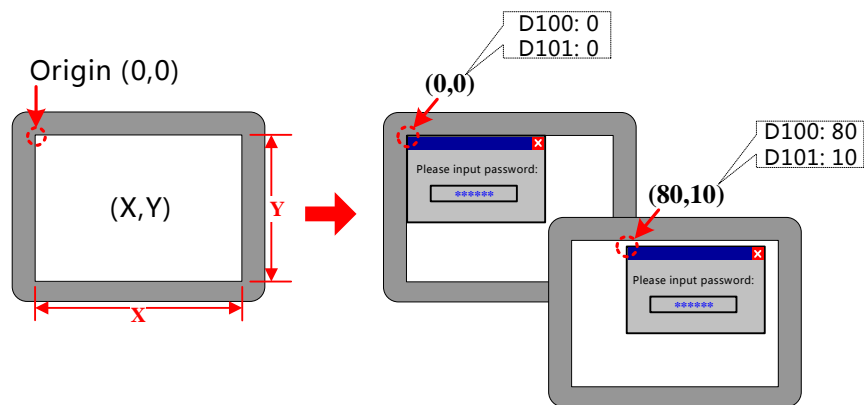

Cancel it to set the coordinates of Indirect Window as constant.

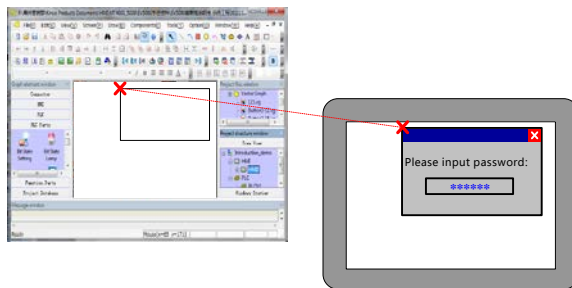

4.9 Graphic Components

Kinco HMIware provides Vector Graph and Bitmap which can be used to display vg or bg pictures in system graph library and graph library in project files window.

[For details about how to build and edit Bitmap and Vector Graph, refer to \[Advanced Part 5.3 Graphic Library\]](#)

4.9.1 Vector Graph

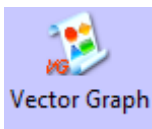

Vector Graph component is used to display vg pictures in system graph library and Project Files Window graph library.



There is no register control in Vector Graph component, and graph doesn't support multiple states switching display. If you want to control vector graph by register, you can chose corresponding vector graphics-Graphics option of other components, like Bit State Switch, Multiple State Setting etc.

[For details about vector graphics in graphics option, refer to \[Advanced Part 4.1.6 Graphics Setting\]](#)

4.9.2 Bitmap

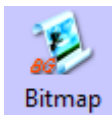

Bitmap component is used to display bg pictures in system graph library and Project Files Window graph library.



There is no register control in Bitmap component, and graph doesn't support multiple states switching display. If you want to control bitmap by register, you can chose corresponding bitmap in Graphics option of other components, like Bit State Switch, Multiple State Setting etc.

[For details about bitmap in graphics option, refer to \[Advanced Part 4.1.6 Graphics Setting\]](#)

4.9.3 Free Plotting

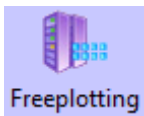

Free Plotting component plots graph according the states of specified bit or word register. This component doesn't open to ordinary customer.

4.9.4 Dynamic Graph

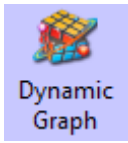

Dynamic Graph can change the position and size of rectangle, ellipse or line according to value in the specified HMI/ PLC register.

Dynamic Graph

Attribute explanation of Dynamic Graph

Graphic Type	Chose the graph type, rectangle, ellipse and line are optional
Line	Set the frame line color, line width and line type
Filling	Set the filling color and picture of rectangle and ellipse

Dynamic Graph Position

Attribute explanation of Dynamic Graph Position

The Upper-left Corner of Variable 	Unchecked	The dynamic graph position(X, Y) are constant.
	Checked	The dynamic graph position(X, Y) read from specified register. X position=specified register, Y position = specified register +1.
The Width/Height of Variable 	Unchecked	The dynamic graph width and height are constant.
	Checked	The dynamic graph width and height read from specified register. Width=specified register, Height= specified register +1.



The component takes the upper-left as base point, X direction moving means increasing towards right. Y direction moving means increasing towards down. The moving unit is pixel

4.9.5 GIF



GIF component is used to display the gif picture, and the switching frequency of gif picture can be controlled.

GIF Attributes

Description of GIF Attributes		
Use Start Address	If checked, when the specified register is ON, GIF displays animation, when register is OFF, GIF displays static picture.	
Use GIF Default Freq	Use the default frequency of gif picture.	
Use defined Freq	User set frequency for the gif picture.	
	Switching Frequency	Different frequencies mean different switching speed of gif picture; the larger value means the slower switching speed. Unit: 100ms.
	Use Variable Frequency	The switching frequency is read from specified register. Unit: 100ms. Note: If the specified register is PLC register, but the HMI does not communication successfully with the PLC all the time, the gif use the default frequency. If the communication is cut off, the gif uses the latest historical value in the specified PLC register.
Load GIF	Load the gif picture from PC, and preview the loaded gif picture in Preview area.	
GIF Preview	Preview the loaded gif picture in this area.	
Use Original Size	If checked, the component size is the same as the gif original size.	



GIF component only support the gif format picture.

4.10 Video Input Component

4.10.1 Video



Video component is used to monitor the industrial site picture in real time, supporting the CVBS signal.

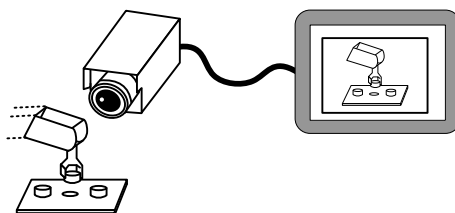

1. Only the HMI with BNC connector can support the Video component
2. Supports PAL and NTSC format. And the video mode are optional in HMI Attribute>>HMI Extended Attributes
3. If the video is displayed in pup up window, the pop up window should be set Video Page in Window Attribute>> Special Attribute

Basic Attributes

The default Word Length of Read Address is 4, each word corresponds to different function attribute as follows:

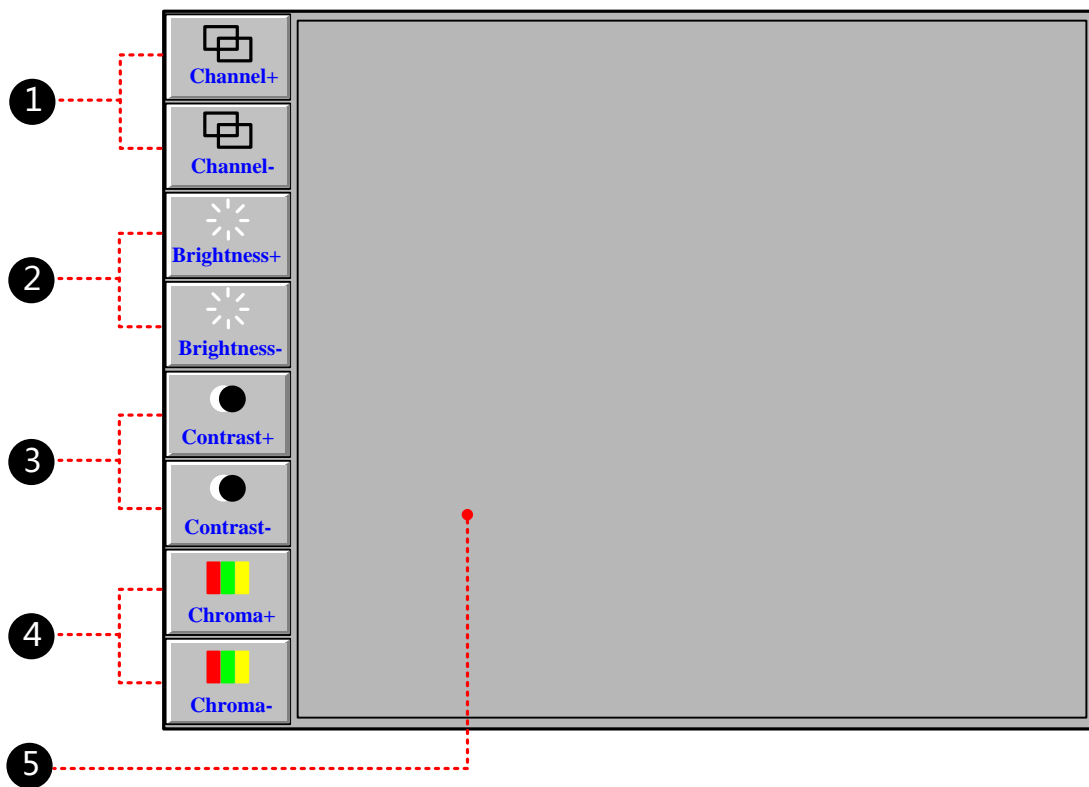

Explanation of Video component Read Address		
Read Address	Function	Description
Specified Address	Switch channel	Switch channels, if the value is 0 , the component displays the video image from channel 0 ; if the value is 1 , the component displays the video image from channel 1;
Specified Address+1	Adjust brightness	Adjustable range: 0~255
Specified Address + 2	Adjust contrast	Adjustable range: 0~255
Specified Address + 3	Adjust chromaticity	Adjustable range: 0~255

[Example] Take MT5620T for example, build a new project.





① Multiple State Setting component, it is used to switch the channels (There are only 2 CVBS port on MT5620T), its attributes are as followings:

Write Address	LW 0(HMI local register)	LW 0(HMI local register)
Setting Mode	Jog++; Addend:1; Upper:1	Jog--; Subtrahend:1; Lower:0
Tag	Use Tag; 0: Channel+; 1:Channel-	Use Tag; 0: Channel-; 1:Channel-

Graphics	<div style="display: flex; justify-content: space-around; align-items: center;"> <div style="text-align: center;"> <p>State 0</p>  </div> <div style="text-align: center;"> <p>State 1</p>  </div> </div> <p>Use Vector Graphics</p>
----------	--



② Multiple State Setting component, it is used to adjust brightness, it attributes are as follows:

Write Address	LW 1(HMI local register)	LW 1(HMI local register)
Setting Mode	Jog++; Addend:1; Upper:255	Jog--; Subtrahend:1; Lower:0
Tag	Use Tag; 0: Brightness+; 1: Brightness +	Use Tag; 0: Brightness-; 1: Brightness -

Graphics	<div style="display: flex; justify-content: space-around; align-items: center;"> <div style="text-align: center;"> <p>State 0</p>  </div> <div style="text-align: center;"> <p>State 1</p>  </div> </div> <p>Use Vector Graphics</p>
----------	--



③ Multiple State Setting component, it is used to adjust contrast, it attributes are as follows:

Write Address	LW 2(HMI local register)	LW 2(HMI local register)
Setting Mode	Jog++; Addend:1; Upper:255	Jog--; Subtrahend:1; Lower:0
Tag	Use Tag; 0: contrast+; 1: contrast +	Use Tag; 0: contrast-; 1: contrast -

Graphics	<div style="display: flex; justify-content: space-around; align-items: center;"> <div style="text-align: center;"> <p>State 0</p>  </div> <div style="text-align: center;"> <p>State 1</p>  </div> </div> <p>Use Vector Graphics:</p>
----------	---

④ Multiple State Setting component, it is used to adjust chromaticity, it attributes are as follows:

Write Address	LW 3(HMI local register)	LW 3(HMI local register)
Setting Mode	Jog++; Addend:1; Upper:255	Jog--; Subtrahend:1; Lower:0
Tag	Use Tag; 0: chromaticity +; 1: chromaticity +	Use Tag; 0: chromaticity-; 1: chromaticity -

Graphics	<div style="display: flex; justify-content: space-around; align-items: center;"> <div style="text-align: center;"> <p>State 0</p>  </div> <div style="text-align: center;"> <p>State 1</p>  </div> </div> <p>Use Vector Graph:</p>
----------	--

⑤ The Video component, its attributes is as follows:

Read Address	LW 0 (HMI local register)
--------------	---------------------------

4.10.2 Camera

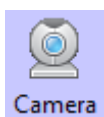

Camera component is also used to monitor the industrial image as the Video component, and the Camera component supports the USB camera video input.

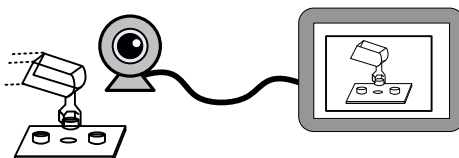

Basic Attributes

Camera component uses the Read Address to open, close, switch the camera.

For example, suppose the Read Address is LW0 (HMI local register), when LW0 is 0, the camera is close; when LW0 is 1, the camera on USB HOST1 is open; when LW0 is 2, the camera on the USB HOST2 is open.



1. The Camera component is only suitable for the HMI with USB HOST port.
2. If there are cameras on both USB HOST1 and USB HOST2, the two cameras can not be open at the same time. That is to say when one camera is open, the other is closed automatically.

4.11 Multiple State Neon Lamp

The Multiple States Neon Lamp component displays text content circularly in neon. Knico HMIware provides Bit State Neon Lamp and Multiple State Neon Lamp, their differences are as follows:

Component	Control Address	Code Type	State Number
Bit State Neon Lamp	Bit	BIN	1~2
Multiple State Neon Lamp	Word	BIN、BCD or LSB	1~256

4.11.1 Bit State Neon Lamp



The Bit States Neon Lamp component displays tag content circularly in neon, supports tag content in state 0 and state 1.

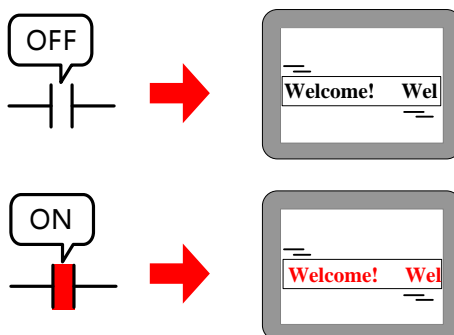

Change the states of Read Address to switching display the tag content in corresponding states.

Bit State Neon Lamp

Detail Description of Bit States Neon Lamp

Moving Style	From left to right	The text moves from left frame to right frame circularly.
	From right to left	The text moves from right frame to left frame circularly.
	From top to bottom	The text moves from top frame to bottom frame circularly.
	Form bottom to top	The text moves from bottom frame to top frame circularly.
Step Length	The distance of each movement, the unit is pixel point.	
Speed	The time interval between previous moving text and next moving text, the unit is ms.	

4.11.2 Bit State Neon Lamp

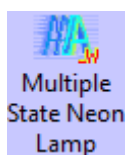

The Bit State Neon Lamp component displays tag content circularly in neon, supports 256 states tag content at most.

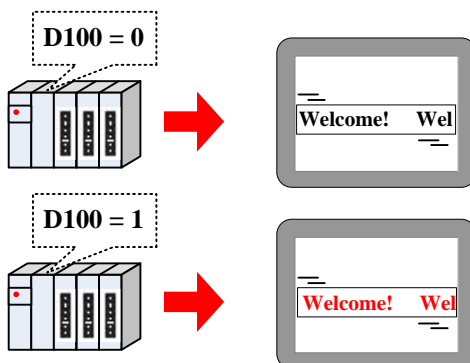

Change the value of Read Address to switching display the tag contents corresponding to the value.

Multiple State Neon Lamp

Detail Description of Multiple State Neon Lamp

Moving Style	From left to right	The text moves from left frame to right frame circularly.
	From right to left	The text moves from right frame to left frame circularly.
	From top to bottom	The text moves from top frame to bottom frame circularly.
	Form bottom to top	The text moves from bottom frame to top frame circularly.
Step Length	The distance of each movement, the unit is pixel point.	
Speed	The time interval between previous moving text and next moving text, the unit is ms.	
State Num	Set the state number of Multiple State Neon lamp, 256 states at most.	

Data	Set the mapping value of each state. When the value in Read Address equals to the corresponding value, the
Mapping	component displays the corresponding tag content of this value.

4.12 Animation Components

In Kinco HMIware, the Animation and Moving Components are used to realize animation effect and make the HMI picture more vivid.

4.12.1 Animation

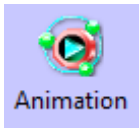

Animation component can preset the trace of moving component, and change the component state and preset trace position according to value of the HMI register or PLC register.

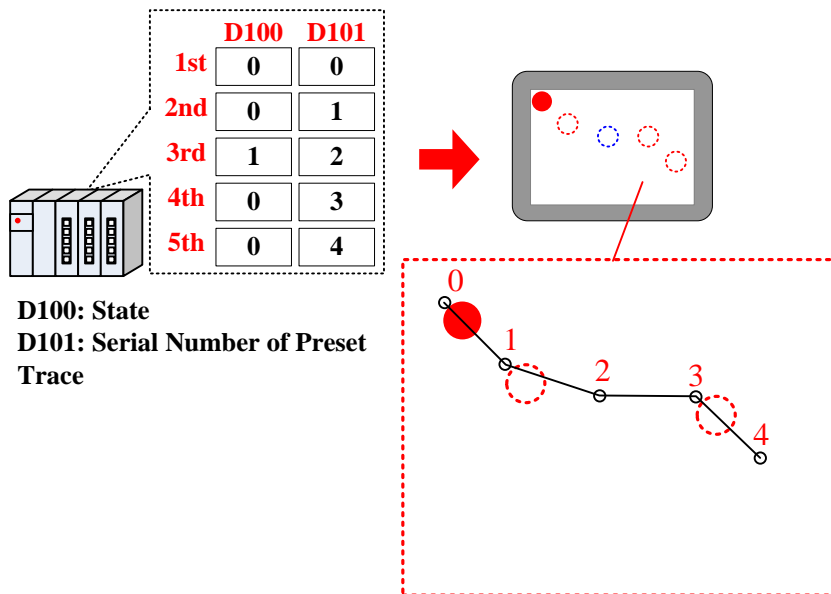

Steps to preset the Animation trace:

Drag the Animation component to the edit area, there will be a “+” icon, press the left mouse button at appropriate position, so a moving position is preset. Press the right mouse button to end the presetting after all the all the positions are set.

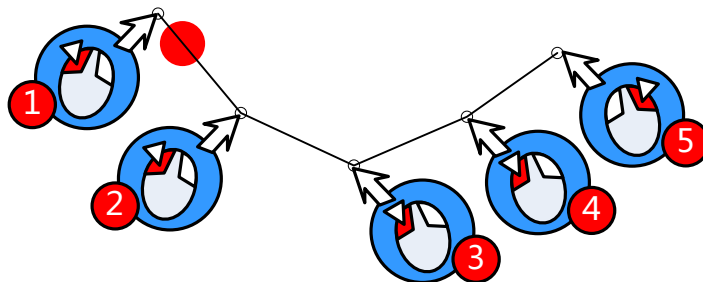

The default word length of Animation component is 2, each word corresponding to the different control function , see the details follows:

Read Address description of Animation Component		
Read Address	Control Function	Description

Specified Address	Component State	When the value in control address equals to the state number of component, the Animation Component display corresponding tag or picture.
Specified Address +1	Number of preset trace	When the value in control address equals to the number , the Animation Component moves to corresponding position.

Animation

Attribution Description of Animation Component.

Moving Node List	No. and coordinates	Set the coordinate position of the moving node on HMI. The number 0 means the first moving node, the number 1 means the second moving node.
	Add Node	Add a moving node at the end of preset trace
	Insert Node	Insert a moving node after the selected moving node
	Delete Node	Delete the selected moving node
	Shift Up	Exchange the position of the selected node and the previous node
	Shift Down	Exchange the position of the selected node and the next node
Size(Width, Height)		Set the display size of Animation component
State Num:		Set the state number of Animation component.

4.12.2 Moving Component

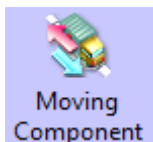

The Moving Component can change the display state and position according to the value of HMI register or PLC register.

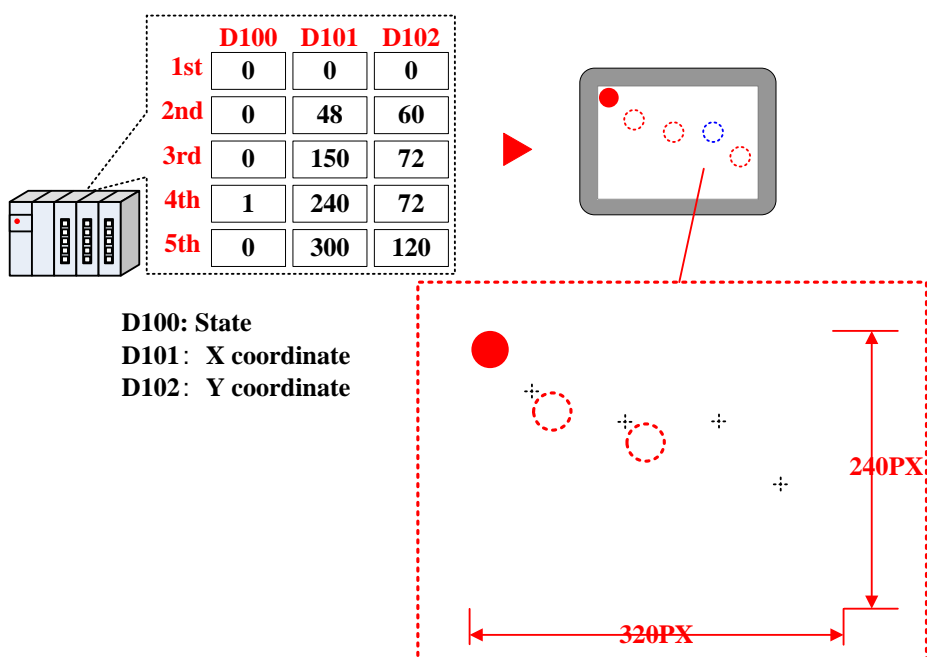

The default word length of Moving Component is 3, each word corresponding to the different control function, see the details follows:

Read Address Description of Moving Component			
Type	X Axis Only	Y Axis Only	X&Y Axis
Specified Address	Component State 256 states at most	Component State 256 states at most	Component State 256 states at most
Specified Address +1	X axis displacement (pixel point)	Y axis displacement (pixel point)	X axis displacement (pixel point)
Specified Address +2	Reserved	Reserved	Y axis displacement (pixel point)

Moving Component

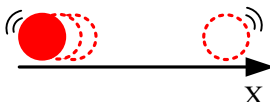
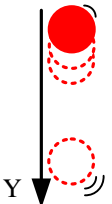
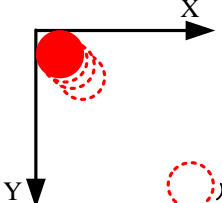
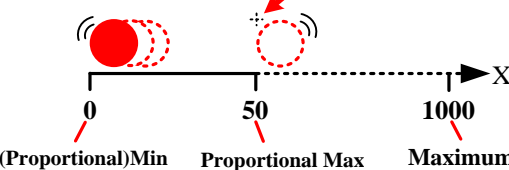
Moving Type Description	
Type	<p>X axis only</p> <p>The component moves along the X axis horizontally</p> 
Type	<p>Y axis only</p> <p>The component moves along the Y axis vertically</p> 
Type	<p>X & Y axis</p> <p>The component moves along the X and Y axis at the same time.</p> 
Type	<p>X Scaling</p> <p>The component moves along the X axis horizontally, but the relative moving position can be set by the input value and proportional value.</p> <p>When the value in register that controls X movement is 1000</p> 

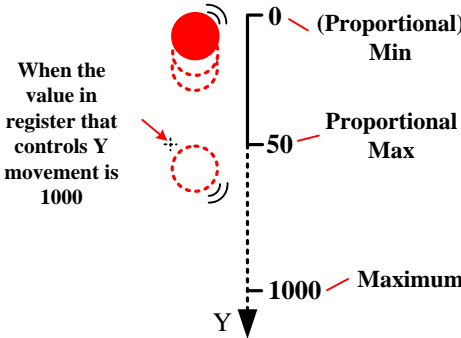
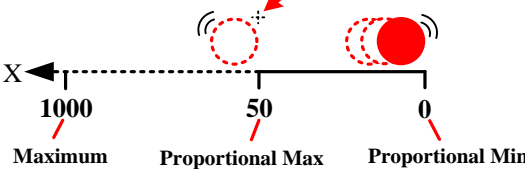
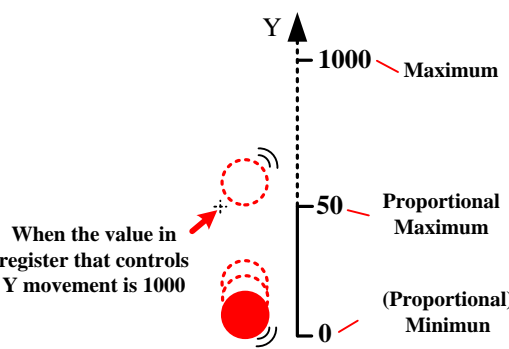
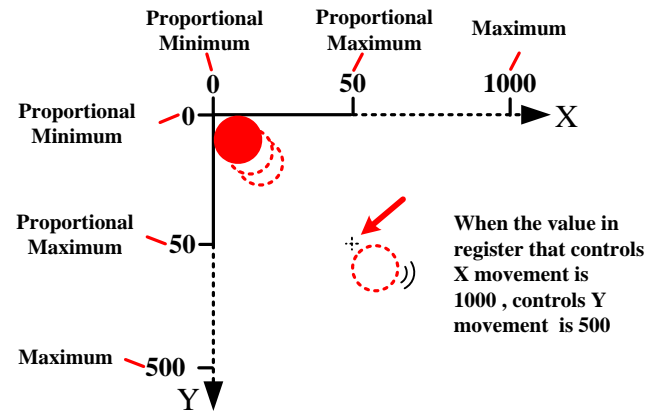
<p>Y Scaling</p>	<p>The component moves along the Y axis vertically, but the relative moving position can be set by the input value and proportional value.</p> 
<p>X Reverse Scaling</p>	<p>It is similar with the X Scaling, but with the reverse direction.</p> <p>When the value in register that controls X movement is 1000</p> 
<p>Y Reverse Scaling</p>	<p>It is similar with the Y Scaling, but with the reverse direction.</p> 
<p>X Scaling, Y Scaling</p>	<p>The component moves along the X and Y axis at the same time, the relative moving position can be set by the input value and proportional value.</p> 
<p>X Scaling, Y Reverse</p>	<p>The component moves along the X and Y axis at the same time, and the</p>

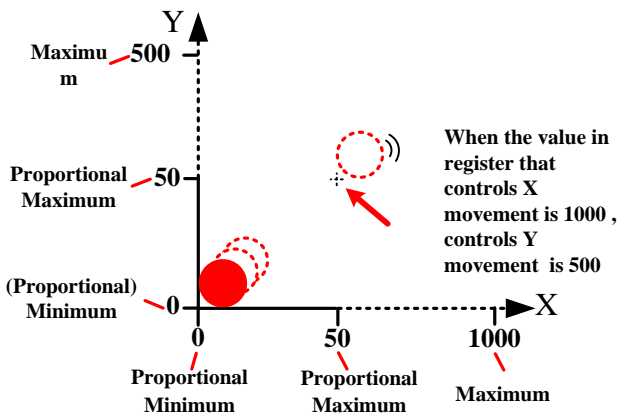
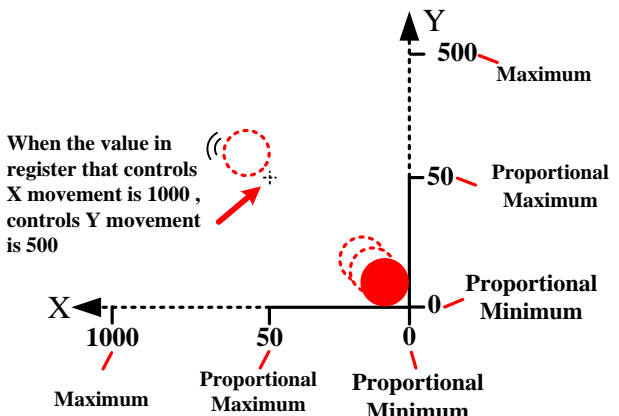
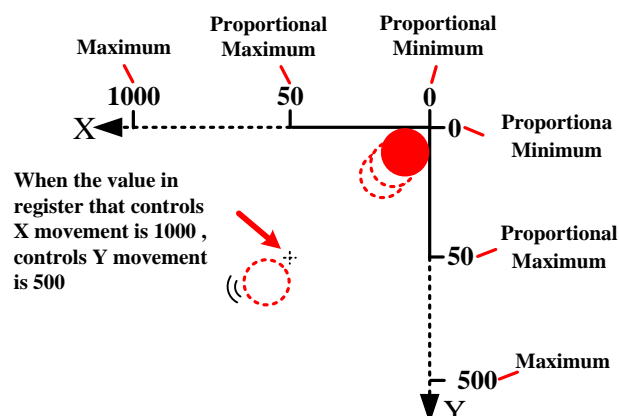
	<p>Scaling</p>	<p>relative moving position can be set by the input value and proportional value, but in reverse direction in Y axis.</p> 
<p>X Reverse Scaling, Y Scaling</p>		<p>The component moves along the X and Y axis at the same time, and the relative moving position can be set by the input value and proportional value, but in reverse direction in X axis.</p> 
<p>X Reverse Scaling, Y Reverse Scaling</p>		<p>The component moves along the X and Y axis with reverse direction, and the relative moving position can be set by the input value and proportional value</p> 
<p>Status Number</p>		<p>Set the status number that can be switching display.</p>

Variable	According to different Type, the Maximum/Minimum of X, Maximum/Minimum of Y, Proportional
Min/Max	Upper/Lower Limit of X and Proportional Upper/Lower Limit of Y are read from specified registers.

※ 1.X Scaling or Y Scaling

Suppose the read data is A, and the actual display position is B. You can get the B according to the following formula:

$$B = \text{Current Position} + (A - \text{Minimum}) * \text{Proportional Value}, \text{ and } \text{Proportional Value} = (\text{Proportional Upper Limit} - \text{Proportional Lower Limit}) / (\text{Maximum} - \text{Minimum})$$

2. X Reverse Scaling or Y Scaling

Suppose the read data is A, and the actual display position is B. You can get the B according to the following formula:

$$B = \text{Current Position} + (\text{Maximum} - A) * \text{Proportional Value}, \text{ and } \text{Proportional Value} = (\text{Proportional Upper Limit} - \text{Proportional Lower Limit}) / (\text{Maximum} - \text{Minimum})$$

4.12.3 Pipeline



Pipeline

Pipeline component is used to build pipeline effect in the HMI program.

Basic Attributes of Pipeline

Basic Attributes of Pipeline			
Basic Attributes	Radius	Set the radius of pipeline.	
	Thickness	Set the thickness of pipeline border.	
	Body color	Set the color of pipeline(the first color)	
	Border color	Set the color of pipe border.	
	Body Color Changeable	If checked, the pipeline color can be changed by specified register.	
		Body color 2	Set the second color of pipeline
		Body color 3	Set the third color of pipeline
		Default color	View the display effect of pipeline
	Flicker	If checked, use specified register to switch on/off the flicker effect.	
	Use Flow Effect	If checked, use specified register to control the flow effect.	
Default Flow Effect	Symbol	Select the flow symbol	
	Copy Symbol to All Pipe	Copy the current flow symbol to all the pipes	
	Symbol Color	Set the color of flow symbol.	
	Copy Color to All Pipe	Copy the current flow symbol color to all the pipes	
	Display Length	Set the length percentage of flow symbol in the pipe, 1~100 are optional.	
	Copy Length to All Pipe	Copy the length percentage to all the pipes	
	User Flowinfo to All Pipe	Copy the flow effect to all pipes.	

	Not use Flowinfo to All Pipe	All the pipes do not use flow effect.
Control Address	<p>If the bit1 of specified register is ON, Pipeline uses the second color; if the bit2 is ON, Pipeline uses the third color; Bit3 is on, Pipeline starts to flicker(when the Flicker is checked), that is to say the pipeline switching displays the first color , second color(bit1 is ON) or third color(bit 2 is ON). If the bit3 is ON, the pipeline display the flow effect(the Use Flow Effect is checked).</p> <p>Note: if the bit1 and bit2 are ON or OFF at the same time, pipeline displays the first color, the flicker is invalid.</p> <p>For example, the Control Address is LW0 (HMI local address), word length is 1.</p> <p>When the LW0 =1 or LW.B0.0 is ON, the Pipeline display the second color; When the LW0 =2 or LW.B0.1 is ON, the Pipeline display the third color; When the LW0 =5 or LW.B0.0 and LWB0.2 are ON at the same time, the Pipeline switching display the first color and the second color. When the LW0 =8 or LW.B0.3 is ON, the Pipeline display the flow effect.</p>	

Pipe Info

Description of Pipe Info		
Pipe List	Number	Number 0 is the first pipeline; Number 1 is the second pipeline and so on.
	Coordinates	The start coordinates of the pipeline component.
	Type	Display the current pipe type, there are HLNE (Horizontal), Bend Node (Bend), VLINE (Vertical).
Pipe Setting	Select the corresponding pipe number, and set its parameters.	
	Type	Set the type of current pipe.
	Coordinates	Set coordinates of current pipe.
Follow Effect	Select the corresponding pipe number, and set its flow effect.	
	Symbol	Set the flow symbol of current pipeline.
	Color	Set the color of flow symbol
	Display Length	Set the display percentage of current pipeline.

4.13 Grid Components

4.13.1 Grid



Grid

The Grid can be selected in row, column or cell. User can set the row number , column number, Select Color, Background Color, Border Color, and the Grid writes the column number and row number to the specified HMI or PLC register.

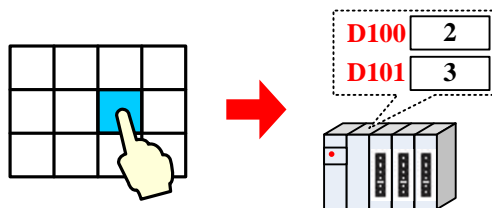

Grid component takes different register number according to the different Type, see the detail as follows:

Type	Row register	Column register	Register number
Select in row	Specified address	—	1
Select in col	—	Specified address	1
Select in cell	Specified address	Specified address +1	2

Grids

Description of Grid Attributes	
Type	Set the select type. <div style="display: flex; justify-content: space-around;"> <div style="text-align: center;"> By Row </div> <div style="text-align: center;"> By Col </div> <div style="text-align: center;"> By Cell </div> </div>
Row/Column	Set the row number and column number.
Color	Set the Select Color, Background Color and Border Color.

4.13.2 Historical Data Display

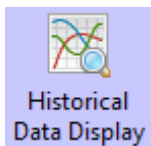

Historical Data Display component read data from specified HMI or PLC continuous registers periodically, and display them in grid.

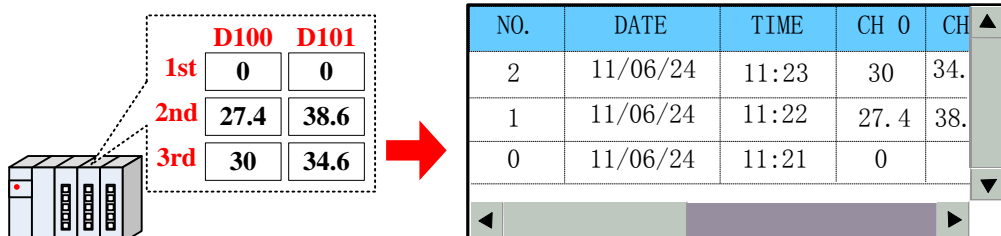

1. The Read Address of Historical Data Display component is register address of the first channel.
2. The Word Length of Historical Data Display depends on the channel number, if the channel number is m (0<m<17), the Word Length is m.
3. When use the Historical Data Display component, one of the Save to Recipe Data Field and Save to

External Device option, or both must be checked.

Display Properties

Detail Description of Display Properties

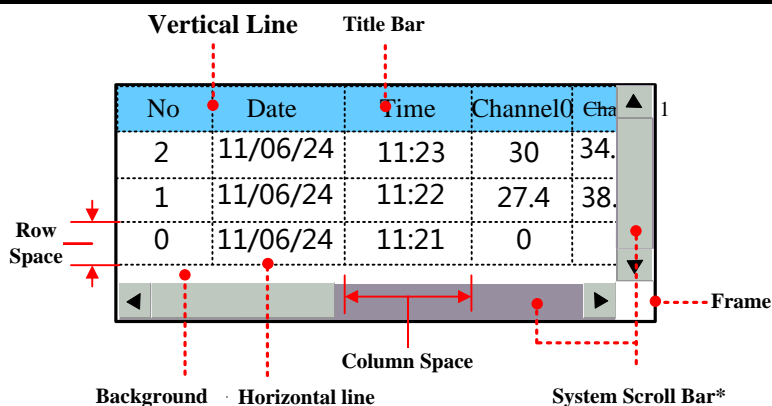

※If the information in Historical Data Display component cannot be displayed entirely, the scroll bar will be built automatically to make user to view the whole information. And the width of system scroll bar can be set in HMI Attributes >> HMI Extended Attributes, ranges from 20~120 pixel.

Channel	The continuous register number, 16 channels at most.	
Sequence No.	Display the sequence number or not.	
Ascending Order	Checked means the sampling data information is arranged in ascending order, that is to say the latest sampling data is displayed at bottom; Unchecked means the sampling data information is arranged in descending order, that is to say the latest sampling data is displayed at top.	
Date/Time Display	Date	Checked means to display the sampling date, and choose the date format, three formats are optional, in the date format, YY means year, MM means month, DD means day.
	Date Separator	Choose the date separator; three formats are optional, for example 11/06/24.
	Time	Checked means to display the sampling time, and choose the time format, three formats are optional, in the date format, HH means hour, MM means minute, SS means second, MS means millisecond.
Color Setting	Set the color for grid background and title bar.	
Border Setting	Set the border color and border line width of grid.	
Separator Setting	Set the separator color, style and width of each row and column in grid, the unit of Row Space and Column Space is pixel point. And check the Horizontal Line means to display horizontal line, check the Vertical Line means to display vertical line.	
Historical Data Query	The data that is saved to the external device can be queried by specified register in Historical Data Query. The default length of specified register is 2.	

	Query by file order	Check the “Query by file order” , when the value in specified register is 0, it means to query today or the latest day’ s historical data, 1 means to query the previous day’ s historical data and so on. For example, there are two csv file in the external device, when the value in specified register is 0, the historical data file saved on 24 th , June, 2011 is queried and displayed, when the value in specified register is 1, the historical data file saved on 21 st , June, 2011 is queried and displayed.
	Query by date	Check the “Query by date” and input the date to the specified register, then the historical data in corresponding date is queried and displayed. The format of inputting date is yyyyymmdd, yyyy means year, mm means month, and dd means day, for example, input 20110624 in the specified register, the historical data sampled on 24 th , June, 2011 is queried and displayed.
Variable Circle	The sampling circle is read from specified register in Time Sampling mode.	



If the Variable Circle is configured, the Variable Circle value will be used preferentially; and the preset value is called when the Variable Circle value cannot not be read because of losing communication..

Background Attribute

Detail Description of Background Attribute

	Time Sampling	Sample the data periodically.
Sampling Methods	OFF→ON trigger sampling	Only when the specified register changes from OFF to ON, the sampling is triggered.
	ON→OFF trigger sampling	Only when the specified register changes from ON to OF, the sampling is triggered..
	OFF←→NO trigger sampling	Only when the specified register changes its status, the sampling is triggered.
	OFF→ON reset trigger sampling	Only when the specified register changes from OFF to ON, the sampling is triggered, and the specified register resets automatically.
	ON→OFF reset trigger sampling	Only when the specified register changes from ON to OFF, the sampling is triggered, and the specified register resets automatically.
	Cycle	Time interval between every two sampling points, the sampling points can be second or hundred milliseconds.
Sam. Type	Continuous	The sampling will continue after all the sampling points are finished.

	Once	The sampling will stop after all the sampling points are finished, the sampling is executed once.
Sampling Points	In the “Once” Sam.Type , the sampling will stop after all the Sampling Points are finished	
Trigger Register Setting	It is the specified register in the “Trigger Sampling” Sampling Method.	
Pause	<p>The default word length is 2. The pause function is used to stop the sampling, the pause address is the specified address. The clear function is used to clear the sample data saved in the flash, the clear address is the specified address+1.</p> <p>Note: If “Historical Data Query” is selected, the display data is from external device, at the time the clear function is disable.</p>	

Channel Properties

Description of Channel Properties					
Display	Checked means displaying this channel data information in grid.				
Data Type	Set the data format of sampling data, supporting format is 16-bit signed, 16-bit unsigned, 32-bit signed, 32-bit unsigned, float, double.				
Min/Max Limit	N/A	Integer	N/A	Decimal	N/A

Save Historical Data

 For details, refer to [\[Advanced Part 4.1.10 Save Historical Data\]](#)



Historical Data Display component and Trend Curve can be used together, but when they sample the same registers and save the data in external device, the sub routine of saving file must be different, or chose only one historical data (Historical Data Display component or Trend Curve.) to save.

Background Print

Select [Use Background Data Print] to enable realtime print historical data. If [Net Print] is select, historical data can be printed in network.

Description of Background Data Print	
Use Background Data Print	Enable the background data print

Print Type	Real-time	Print every sampling data in real-time.
	Batch	Trigger printing when the sampling point number equals the set value.
	Point	Set the sampling points number in batch printing
	Trig	Trigger printing when the specified register satisfies the set condition.
Net Print	Enable the Net Print, download the program to HMI, and then run the Net Print.exe to connect the network printer to print historical data. Note: If the Net Print is checked, the local printing is invalid. Even if the local printer is connected to HMI, the HMI still cannot print via local printer.	
Print Content	Print Serial Number	Print serial number of each sampling point.
	Print Table Header	Print the table header of Historical Data Display component.
	Print Grid	Print the grid ground of Historical Data Display component.
	Print Date	Print date of each sampling data, and select the date format and separator. There are three date format and separator, YY means year , MM means month, DD means day.
	Print Time	Print time of each sampling data, and select the time format and separator. There are three date formats and separators, HH means hour, MM means minute, SS means second, MS means millisecond.
Grid	Set the line type, line width and color of grid background.	

[For details, refer to \[Advanced Part 13.3.2 Network Print\]](#)

Title Bar Properties

User can set the title name a font in this page, see as follows:

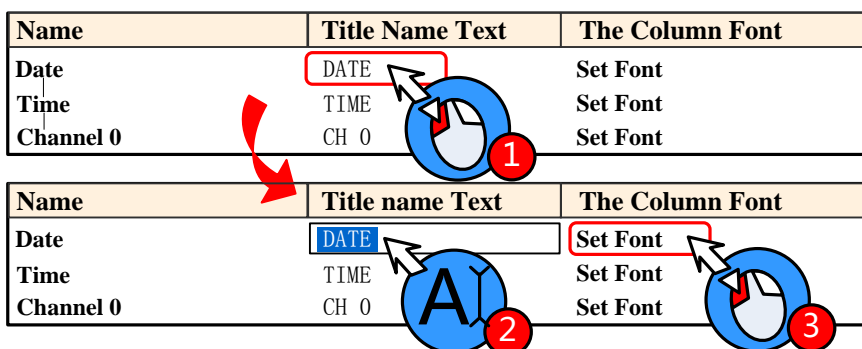

Back Ground Setting	Set the background, title bar, frame color and frame width of table.
Separator Setting	Set the separator color, line style, width and row space, column space. The unit of row space and column space are pixel point. Check the “Vertical Line” means displaying the vertical separator line, and check the “Horizontal Line” means displaying the horizontal separator line.
Title Bar Setting	Set the display name and font attribute of table title bar. For details, refer to [Advanced Part 4.13.2 Historical Data Display]

4.13.4 Operation Log

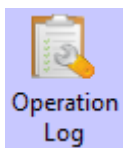

The Operation Log component recode the all the operations on the HMI and display them in table, these recode can be saved as CSV file in external memory device.

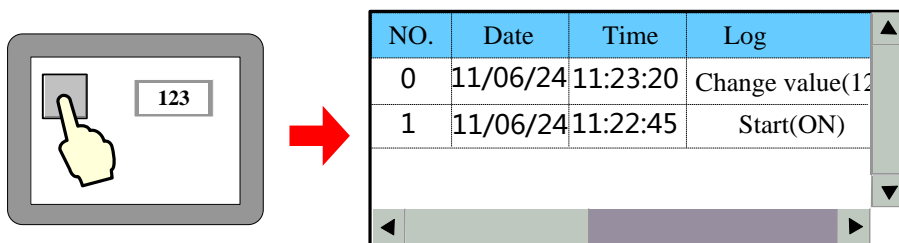

1. The Read Address of Operation Log is the specified register that is used to query the operation log, the default word length is
2. The Operation Log can display operation result of Bit State Setting, Number Input , Text Input component and so on.
3. The Operation Log component is only suitable for HMI with SD card or U disk.

Table Display Attributes

Description of Table Display Attributes

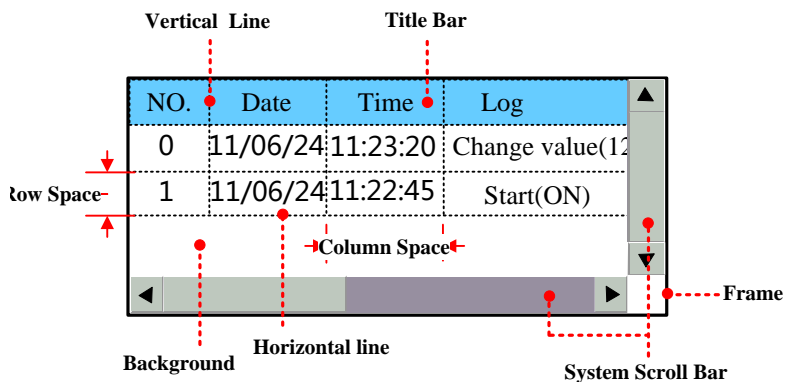

* When the operation log cannot be wholly displayed in vertical or horizontal direction, system will provide scroll bar automatically. The width of system scroll bar can be set in HMI Extend Attributes of HMI Attributes, the width are optional from 20 to 120(pixel).

Table Display	Time	Checked means displaying the operation time and chose the time format, three formats are operational. HH means hour, MM means minute, SS means second, MS means millisecond.
	Date	Checked means displaying the operation date and chose the time format, three formats are operational, YY means year, MM means month, DD means day.
	Date Separator	Choose the date separator, three formats are operation, for example 11/06/24
	Sequence No.	Checked mean displaying sequence number of each operation log.
	User Name*	Checked means displaying operation user name.
	Ascending Order	Checked means that the operation logs are arrange in ascending time order, that is to say the latest log is at the bottom; unchecked means that the operation logs are arrange in descending time order, that is to say the latest log is on the top.
Background Setting	Set the background, title bar, frame color and frame width of operation log table.	
Historical Logs Query	Query by File Order	If the “Query by File Order” is checked, 0 in specified register means to call today’s log or latest day’s log; 1 means to call the previous day’s log and so on. For example, there are two operation log csv file in external memory device, they are 20110621.csv and 20110624.csv, when the value in specified register is 0, the csv file that is saved on 24 th , June, 2011 is called, when the value in specified register is 1, the csv file that is saved on 21 st , June, 2011 is called and displayed.
	Query by Date	If the “Query By Date” is checked, input date in specified register to call the corresponding operation log. The inputting date format is yyyyymmdd, yyyy means year, mm means month, dd means day. For example, input 20110624 to specified register, the operation log that is saved on 24 th , June, 2011 is called and displayed.

Separator Setting	Set the separator color, line style, width and row space, column space. The unit of row space and column space are pixel point. Check the “Vertical Line” means displaying the vertical separator line, and check the “Horizontal Line” means displaying the horizontal separator line.
Title Bar Setting	Set the display name and font attribute of table title bar. For details, refer to [Advanced Part 4.13.2 Historical Data Display]

*When using the User Permission function, the User Name column displays the current user name.

Related attributes settings of Operation Log.

>> Operation Recode Storage Setting

User needs to set the storage path for Operation Log storage file in HMI Attributes>> HMI Extended Attributes>>

Operation Recode Storage Setting.

[For details, refer to \[Advanced Part 6.1.3 HMI Extended Attributes\]](#)

If the CSV file is stored by Daily File type, the storage path is log/subdirectory/yyyymmdd.csv; if the CSV file is stored by Signal File type, the storage path is log/subdirectory/subdirectory.csv. Note: yyyyymmdd is the date on which the operation log is built, for example 20110101.

Recode Operations setting in component attributes.

The components whose operation log needs recoding must check the Recodes Operations in Control Setting of component attributes and input description information in the text frame.

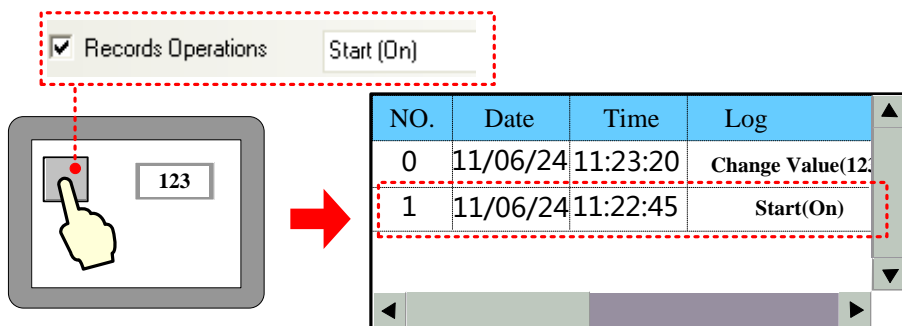

4.13.5 Data Report



Data Report is used to display the data that is logged in the Data Logger and stored in external memory device on the HMI in report. The logged registers can be continuous or discontinuous registers.



Detail Description of Data Report			
Data Report Attribute	Report mode	Real time	Update the report data timely according to the settings.
		History	Input the time range to query the historical report.
	Report type	Trigger Report	In the user defined time interval, trigger the sampling to get the instant

		data.
	Free Report	Display all the data in the user defined time interval. Note: In the real-time Report Mode, if the Free Report exceeds the user defined length, the earliest data will be deleted, then the whole report moves up
	Daily Report	Display the data of one day. Note: In the real-time Report Mode, the Daily Report is displayed in circle. The new data is displayed at the bottom of report. If the report exceeds the length of row number, the newest data displays at the top of report, and all the data in previous circle will be deleted, only the newest row data is reserved, and then start a new circle.
	Monthly Report	Display the data of the moth
	Quarterly Report	Display the data of three months
	Annual Report	Display the data of a year.
Dis. Order	By Order	The sampling data is sequenced by time order; the newest data is at the bottom.
	Reverse	The sampling data is sequenced by reverse time order, the newest data is at the top
Report Line	Set the displaying lines of report, this parameter is only suitable for the Trigger Report and Free Report. Note: 1. The line number of Daily Report is created automatically according to the Timer Interval, for example, the time interval is 1 hour, so the line number is 24. 2. The line number of Monthly Report is 31, Quarterly Report is 3, and Annual Report is 12. 3. In the "History" Report mode, the line number of Free Report and Free Report depends on the user defined time interval.	
Get Value Type	There are five options; they are Instantaneous Value, Min Value, Max Value, Average Value and Added Value. When the Get value Type is one of Min Value, Max Value, Average Value or Added Value, the report displays the min value, max value, average value or added value of all the sampling values in a circle.	
Time Record	There are Begin Time, Mid Time, and End Time. The time that displayed in the report can be begin time, middle time or end time.	
Empty Data	Specified Value	When there is no value in sampling register, the report displays specified

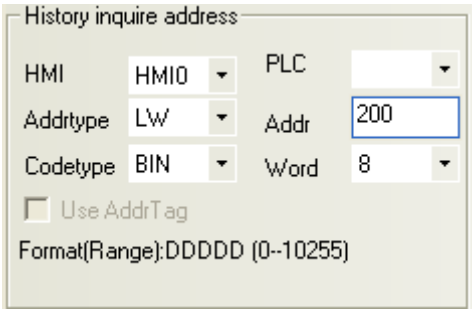
<p>Process</p>	<p>value, the default value is 0.</p> <hr/> <p>Last Valid Value When there is no value in sampling register, the report displays the last valid value.</p>
<p>Time Interval</p>	<p>The time interval of report, there are two options, they are minute and hour. Note: This option is only suitable when the Free Report and Daily Report are selected. Because the time interval of Monthly Port and Quarterly Report are month, and time interval of Annual Report is year.</p>
<p>History Inquire Address, the word length is 8.</p>	
<p>History Inquire Address</p>	<p>Trigger Report</p> <p>Start Date: specified address, word length is 2, input year and date in this address. Start Time: specified address +2, word length is 2, input time (hour, minute and minute) in this address. End Date: specified address +4, word length is 2, input year and date in this address. End Time: specified address +6, word length is 2, input time (hour, minute and second) in this address.</p> <p>Take the following picture for example, the specified address is LW200, and user wants to query the data between 9:30:40 14th, Aug, 2012 and 14:16:30 15th, Aug, 2012.</p>  <p>So the specified addresses are as follows:</p> <p>Start Date: LW200=20120814 Start Time: LW202=93040 End Date: LW204=20120815 End Time: LW206=141630</p>
<p>Trigger Report</p>	<p>Start Date: specified address, word length is 2, input year and date in this address. Start Time: specified address +2, word length is 2, input time (hour, minute and minute) in this address. End Date: specified address +4, word length is 2, input year and date in this address. End Time: specified address +6, word length is 2, input time (hour, minute and second) in this address.</p> <p>Take the following picture for example, the specified address is LW200, and user wants to query the data between 9:30:40 14th, Aug, 2012 and 14:16:30 15th, Aug, 2012.</p>

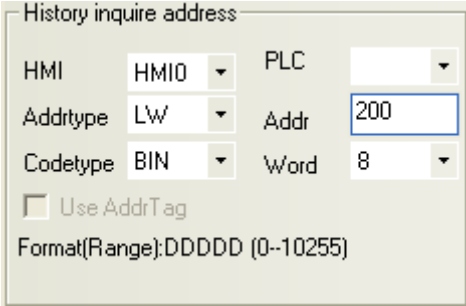
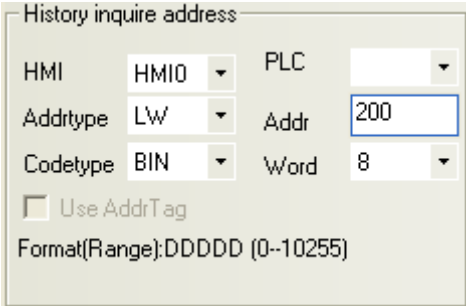
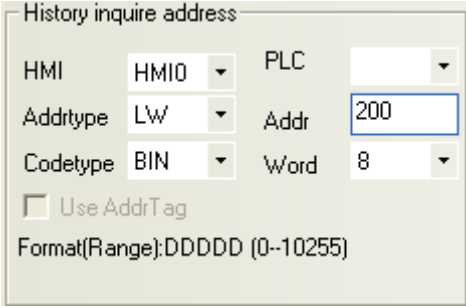
	 <p>So the specified addresses are as follows:</p> <p>Start Date: LW200=20120814</p> <p>Start Time: LW202=93040</p> <p>End Date: LW204=20120815</p> <p>End Time: LW206=141630</p>
Daily Report	<p>The specified address, word length is 2, and input year and date in this address.</p> <p>Take the following picture for example, the specified address is LW200, and user wants to query the data on 14th, Aug, 2012.</p>  <p>So the specified address is as follows:</p> <p>LW200=20120814</p>
Monthly Report	<p>The specified address, word length is 2, and input year and month in this address.</p> <p>Take the following picture for example, the specified address is LW200, and user wants to query the data in Aug, 2012.</p>  <p>So the specified address is as follows:</p> <p>LW200=201208</p>
Quarterly Report	<p>The specified address, word length is 2, and input year and quarter number in this</p>

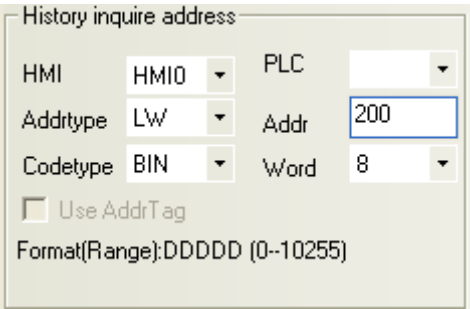
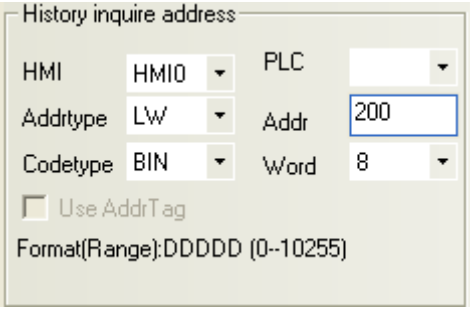
	<p>address.</p> <p>Take the following picture for example, the specified address is LW200, and user wants to query the data of the third quarter 2012.</p>  <p>So the specified address is as follows :</p> <p>LW200=201203</p>
Annual Report	<p>The specified address, word length is 2, and input year in this address.</p> <p>Take the following picture for example, the specified address is LW200, and user wants to query the data of 2012.</p>  <p>So the specified address is as follows :</p> <p>LW200=2012</p>
Trig history inquire	When the specified register satisfies the set condition, output report data.
	OFF→ON Only when the specified register changes from OFF to ON, HMI outputs report data.
	ON→OFF Only when the specified register changes from ON to OFF, HMI outputs report data.
	OFF↔ON Only when the specified register changes its status, HMI outputs report data.
	OFF→ON(reset) Only when the specified register changes from OFF to ON, HMI outputs report data, and then reset the specified register automatically.
ON→OFF(Reset) Only when the specified register changes from ON to OFF, HMI outputs report data, and then reset the specified register automatically.	

Data Report Channel

Detail Description of Data Report Channel

Data Logger	Click this button to pop up Data Logger library.	
Data Report Channel List	Click this button pop up the dialog box to choose channels.	
	Data Sample List	Display all the sampling data in the Data Logger library.
	Data Sample Channel	Display all channel information of one sampling data.
	The data-report channel list	Display the selected channels of current report.
Data report channel.	Set the title, integer and decimal of report channel.	

Data report display attribute

Details of Data report display attributes		
Serial number	Display the serial number of sampling data or not.	
Display time	If checked, report displays the sampling time, and chooses the time format and separator. There are three formats optional, HH means hour, MM means minute, SS means second, MS means millisecond.	
Back color	Set the background color and title bar color.	
Display date	Date Format	Display sampling date, and choose the date format, there are three formats optional, YY means year, MM means month and DD mans day.
	Separator	Select the date separator, three formats are optional, for example 12/07/19.
Separator border settings	Set the color, type and width of separating line, and set the width of each row and column, the unit is pixel If the Horizontal Line is checked, report displays horizontal separator, if the Vertical Line is checked, report displays vertical separator,	
Title bar settings	Set the display name and font of title bar.	

Data Report Control

Details of Data Report Control attributes		
Pause Address	In real-time report mode, use a bit register to pause data sampling, ON means pause, OFF means outputting data.	
Data clear address	In real-time report mode, use a bit register to clear the sampling data in Data Report Display.	
	OFF→ON	Only when the specified register changes from OFF to ON, HMI clears the sampling data in Data Report Display.
	ON→OFF	Only when the specified register changes from ON to OFF, HMI clears the

		sampling data in Data Report Display.	
	OFF \leftrightarrow ON	Only when the specified register changes its status, HMI clears the sampling data in Data Report Display.	
	OFF \rightarrow ON(Reset)	Only when the specified register changes from OFF to ON, HMI clears the sampling data in Data Report Display, and then reset the specified register automatically.	
	ON \rightarrow OFF(Reset)	Only when the specified register changes from ON to OFF, HMI clears the sampling data in Data Report Display., and then reset the specified register automatically.	
Sample Data Export	Export Dir	The subroutine name of the exported sample data file in the external memory device, the default name is ReportToCSV, user can modify it himself and the detail routine in external memory device is :\\external memory device\export\Export Dir, the file name is named according to the saving time: year-month-day, hour: minute: second: millisecond, for example 20120903-110552.csv File format: csv.	
	Save Disk	Save the exported data to the external memory device: SD card, USB1 or USB2.	
	Export data	When the specified register satisfies the set condition, HMI exports data.	
	Trigger Param.	OFF \rightarrow ON	Only when the specified register changes from OFF to ON, HMI exports report data.
		ON \rightarrow OFF	Only when the specified register changes from ON to OFF, HMI exports report data.
		OFF \leftrightarrow ON	Only when the specified register changes its status, HMI exports report data.
		OFF \rightarrow ON(reset)	Only when the specified register changes from OFF to ON, HMI exports report data, and then reset the specified register automatically.
ON \rightarrow OFF(Reset)		Only when the specified register changes from ON to OFF, HMI exports report data, and then reset the specified register automatically.	

DataChannel Print

Description of print attributes

Enable background data print	Check the option to enable print function for Real Time Data Report. Note: only the Real Time report mode support print function.		
Mode	Print per point	Print is triggered be every sampled point.	
	Print per batch	When number of sampled points equals to preset number of points, print is triggered.	
	Number of points	Set number of points for print per batch	
	Trigger by register	Print is triggered when the assigned register satisfy corresponding condition. There are up to 5 trigger modes selectable:	
		OFF→ON	Print is triggered when the assigned registers changes form OFF to ON.
		ON→OFF	Print is triggered when the assigned registers changes form ON to OFF.
		OFF↔ON	Print is triggered when the assigned register changes states.
OFF→ON (Auto reset)		Print is triggered when the assigned registers changes form OFF to ON. Then the assigned register resets automatically.	
ON→OFF (Auto reset)	Print is triggered when the assigned registers changes form ON to OFF. Then the assigned register resets automatically.		
Net print	Enable the Net Print, download program to HMI. And then run the NetPrint.exe to connect network printer to print Data Report. Note: if the Net Print is checked, the local printing is invalid. Even If the local printer is connected to HMI, the HMI still cannot print via local printer.		
Print setting	Print Sequence No.	Print sequence NO. of sampled data.	
	Print Title	Print the title of data report display component.	
	Print Grid	Print grid background of data report display component.	
	Print Date	Check this option to print date for each sampled data, and set date format and separator. There are up to 3 data formats and separators selectable. YY indicates year; MM indicates month; DD indicates day.	
	Print Time	Check this option to print time for each sampled data, and set time format and separator. There are up to 3 time formats and separators selectable. HH indicates hour; MM indicates minute; MS indicates millisecond.	
Grid attributes	Set grid attributes such as grid line style, width, color. Also the title and font are settable here.		

Page Display Setting

Details of Page Display Setting attributes

Number of items per page	Maximum items displayed in one page
TotalPages Addr	Total page number is calculated according to inquiry time:total page=number of total

	items/Number of items per page
PageNumber Addr	Users could unquiry by page number, Range:0~(Total page-1),0 indicates the first page.



1. Do not put multiple free reports in a same window, it will affect the communicate speed.
2. Do not add too many data channels in a signal Free Report.
3. If there are multiple free reports or multiple channels report in a same window, please use the minute or hour as Time Interval.
4. If you want to plug off the external memory device when HMI is in operation, we suggest using the safe mode, but not plug it off directly. Safe Mode: set the LB9153 (SD card), LB9154 (USB1), LB9155 (USB2) OFF first, then plug of the corresponding memory device.
5. When you download the project again, check the Clear data report option in KHDownload, or the residual information may cause the data error for the new sampling data.

Take the MT4522T for example, suppose the sampling address is Dword0, three channels' data, and the sampling data is stored in SD card, user can query the data in any time interval.

① Build a new project, and add a Data Logger, the parameters are as follows:



Data Sample HMI	HMI0	
Sample Point	10	
Sample Type	Circling Sample	
Get Data Type	Sample Continue	
Channel	3	
Sample Circle	10	
Sample channel	Data Type	16-bit signed/32-bit signed/float
	Description	Channel 0/Channel 1/Channel 2

Data Sample Control

Sample Address	D0	
Sample Data Save	Save Disk	SD Card
	Save Dir	SampleDataStore

② Build a Data Report in Frame0 to display data in the Data Logger , the attributes setting is as follows: :

Data report attribute	Report mode	History
	Report type	Trig type
	Disp.type	By order
	Get value type	InstantaneousValue
	Empty data process	0
History inquire address	LW0	

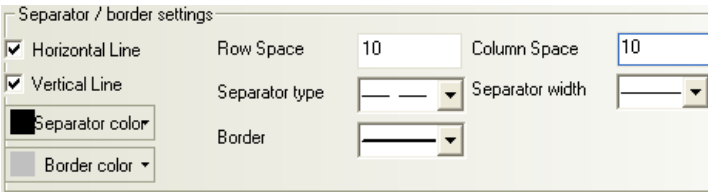
Trig history inquire	LB0, Trigger type: OFF>>ON, Reset			
Data report channel:				
The data-report channel list	Add channel 0 and chann2 to this list			
Data report Channel	Integer	4	Decimal	2
Data report display attribute				
Serial Number	Checked			
Display time	Checked, the format is HH:MM:SS			
Back color	Back:  (light yellow); title:  (light blue)			
Display date	Date format: YY*MM*DD; separator: /			
Separator/border setting				
Title Bar Setting	Default setting.			

3 Put 4 Number Input components and a Bit State Switch in frame0:

Start Date	LW0, DWORD
Start Time	LW2, DWORD
End Date	LW4, DWORD
End Time	LW6, DWORD
Inquire Trigger	LB0; Switch Type: toggle.

4 Put 3 Timer components in frame0 to simulate the change of D_Word registers, the attributes setting are as follows:

Mode	Periodical Jog++(circle)
Data Type	Word
Asc Value	1/6/3
Upper	100/150/200
Addr.Type	D_word
Address	0/1/3
Value Type	Unsigned Int (word length 1)/Signed Int (word length 2)/float (word length 2)
Timer	Trigger mode: All time, Execution Cycle:10

After a period of time, suppose the HMI system time is 2012/11/09, 16:50:00, we want to query the data between 16:40:30 and 16:41:00, the operation is as follows.

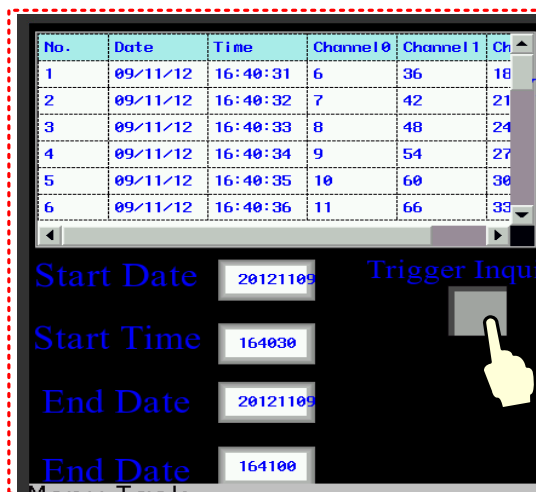

4.13.6 Data Curve



Data Report Curve component is used to display data that is logged in the Data Logger and stored in external memory device on the HMI in curves. The logged registers can be continuous or discontinuous registers. newly added. Via the Data Report Curve component, users could display the sampled data in trend curves on HMI.

Data Report Curve

Detail Description of Data Report Curve			
Data Report Curve Attribute	Report mode	Real time	Update data report curve timely according to the settings.
		History	Query historical data report curve according to input time range.
	Report type	Trigger Report	During defined time interval, trigger sampling to get instant data.
		Free Report	Display all the sampled data in defined time interval. Note: In Real Time mode, if Free Report exceeds the defined length, then the earliest data will be deleted, and the whole report moves up.
		Daily Report	Display the data of one day. Note: In real-time Report Mode, the Daily Report is displayed in circle. The new data is displayed at the bottom of report. If the report exceeds the length of row number, the newest data displays at the top of report, and all the data in previous circle will be deleted, only the newest row data is reserved, and then start a new circle.
		Monthly Report	Display the data of one month.
		Quarterly Report	Display the data of three months.
	Display Order	By Order	The sampled data is sequenced by time order; the newest data is at the bottom.
		Reverse	The sampling data is sequenced by reverse time order, the newest data is at the top.
	Total Points	Set number of total points of Data Report Curve. It is only valid for Trigger Report and Free Report in Real Time Report mode.	

		Note: If the number of sampled points exceeds number of total points, the earliest data will be deleted, and the newest sampled data will be displayed at the end of the curve.	
	Get Value Type	There are five options: Instantaneous Value, Min Value, Max Value, Average Value and Added Value. When Min Value, Max Value, Average Value or Added Value is set, it will calculate all the sampled data during set time interval, and output corresponding Min Value, Max Value, Average Value, Added Value.	
	Time Record	There are Begin Time, Mid Time and End Time selectable for time displayed in report.	
	Empty Data Process	Specified Value	When there is no value in sampled register, the report displays specified value, the default specified value is 0.
		Last Valid Value	When there is no value in sampled register, the report displays the last valid value.
	Time Interval	There are two options for report time interval: minute and hour. Note: This option is only suitable when Free Report and Daily Report. Because time interval for Monthly Report, Quarterly Report and Annual Report are fixed as month, three month and year respectively.	
History Inquire Address	History Inquire Address, word length is 8.		
	Trigger Report	Start Date: specified address, word length is 2, input year and date in this address; Start Time: specified address+2, word length is 2, input time (hour, minute and second) in this address; End Date: specified address+4, word length is 2, input year and date in this address; End Time: specified address+6, word length is 2, input time (hour, minute and second) in this address; 【Example】 It is the same with Data Report Display component.	
	Free Report	Start Date: specified address, word length is 2, input year and date in this address; Start Time: specified address+2, word length is 2, input time (hour, minute and second) in this address; End Date: specified address+4, word length is 2, input year and date in this address; End Time: specified address+6, word length is 2, input time (hour, minute and second) in this address; 【Example】 It is the same with Data Report Display component.	
	Daily Report	The specified address, word length is 2, input year and date in this address. 【Example】 It is the same with Data Report Display component.	
	Monthly Report	The specified address, word length is 2, input year and month in this address. 【Example】 It is the same with Data Report Display component.	
	Quarterly Report	The specified address, word length is 2, input year and quarter number in this address. 【Example】 It is the same with Data Report Display component.	
	Annual Report	The specified address, word length is 2, input year in this address. 【Example】 It is the same with Data Report Display component.	
Trig history inquire	Output data report curve when the specified register satisfies the set condition.		
	OFF→ON	Only when the specified register changes from OFF to ON, HMI outputs data report curve.	
	ON→OFF	Only when the specified register changes from ON to OFF, HMI outputs data report curve.	
	OFF←→ON	Only when the specified register changes its status, HMI outputs data report curve.	
	OFF→ON	Only when the specified register changes from OFF to ON, HMI outputs data report curve,	

	(Auto reset)	and then reset the specified register automatically.
	ON→OFF	Only when the specified register changes from ON to OFF, HMI outputs data report curve,
	(Auto reset)	and then reset the specified register automatically.

Data Report Channel

Detail Description of Data Report Channel

Data Logger	Touch this button to pop up Data Logger library.	
Data Report Channel List	Touch this button to pop up dialog box to choose channels.	
	Data Sample List	Display all sampling data added in the Data Logger Library.
	Data Sample Channel	Display all channel information of one sampling data group.
	The data-report channel list	Display all the channels added to the current report.
Variable Max/Min Value Setting	<p>Check this option, the report channel read maximum and minimum value from specified registers.</p> <div data-bbox="448 857 917 987" style="border: 1px solid black; padding: 5px;"> <input checked="" type="checkbox"/> Channel use variable limit: The register address order is Y Min,Y Max </div> <p>For example: The specified address is LW20, then LW20 indicates the minimum value and LW21 indicates the maximum value.</p> <div data-bbox="448 1102 879 1532" style="border: 1px solid blue; padding: 5px;"> <p>Address Setting</p> <p>HMI: <input type="text" value="HMI0"/> OK</p> <p>PLC No.: <input type="text" value="0"/> Cancel</p> <p>Port: Net</p> <p><input type="checkbox"/> Change Station Num</p> <p>Address Type: LW</p> <p>Address: <input type="text" value="20"/></p> <p>Code Type: BIN</p> <p>Format (Range): DDDDD (0--10255)</p> <p><input type="checkbox"/> Use Address Tag</p> </div>	
Data report channel	Set the title, integer and decimal of report channel.	

DataReport Control

Detail Description of DataReport Control

Pause address	In real-time report mode, use a bit register to pause data sampling, ON means pause, OFF means outputting data.	
Data clear address	In real-time report mode, use a bit to clear the sampling data in Data Report Curve.	
	OFF→ON	Only when the specified register changes from OFF to ON, HMI clears data report curve.

	ON→OFF	Only when the specified register changes from ON to OFF, HMI clears data report curve.
	OFF←→ON	Only when the specified register changes its status, HMI clears data report curve.
	OFF→ON (Auto reset)	Only when the specified register changes from OFF to ON, HMI clears data report curve, and then reset the specified register automatically.
	ON→OFF (Auto reset)	Only when the specified register changes from ON to OFF, HMI clears data report curve, and then reset the specified register automatically.

Page Display Setting

Detail Description of Page Display Setting	
Number of items per page	Maximum items displayed in one page.
TotalPage Addr	Total page number is calculated according to inquiry time: total page=number of total items/Number of items per page.
PageNumber Addr	Users could inquiry by page number, Range: 0~(total page-1). 0 indicates the first page.

Extended Attributes

Detail Description of Extended Attributes		
Channel Properties	Channel	Set line style and width.
	Connect Style	Dot, LINE, X axis projection, Y axis projection.
	Node Properties	Set node graph, node size, node color.
Use Grid	Set line number, column number, background color, grid line width, grid line style and grid line color.	

Scale

Detail Description of DataReport Control		
Horizontal Scroll Bar	Check this option to use the system scroll bar. Users can set scroll bar width range 20~120 pixels.	
Vertical Axis Scale Reference Channel	Channel	The maximum/minimum value of the vertical axis takes the maximum/minimum value of the reference channel.
Use Vertical Axis Scale	Check this option to display vertical axis scale	
	Scale color	Set vertical axis scale color
	Display Scale Frame	Display vertical axis scale frame
	Major Scale Number	Set major scale number
	Major Scale Length	Set major scale length, unit: pixel.
	Minor Scale Number	Set minor scale number.
Use Vertical Axis Scale	Minor Scale Length	Set minor scale length, unit: pixel.
	Check this option to display vertical axis scale label.	

Label	Label Font	Set the label font
	Integer	The integer number of scale (Users cannot adjust it).
	Decimal	The decimal number of scale (Users cannot adjust it).
Use Horizontal Axis Time Scale	Check this option to display horizontal axis scale.	
	Scale Color	Set horizontal axis time scale color
	Display Scale Frame	Display horizontal axis time scale frame
	Display Relative Time	Horizontal axis starts with the first sampled point, and its displayed time is 0.
	Time scale interval	The time interval between two time scales, the unit is sampling circle.
	Length	Set the length of time scale, the unit is pixel.
	Mark each sampling point scale	Mark a scale on each sampling point.
	Length	Set the length of each sampling points, the unit is pixel.
Use Horizontal Axis Time Scale Label	Check this option to display the horizontal time scale label.	
	Label Font	Set the scale label font.
	Integer	Display and set time format. There are three formats: HH:MM:SS, HH:MM, HH:MM:SS:MS.
	Decimal	Display and set date format, there are three formats: DD*MM*YY, MM*DD*YY, YY*MM*DD. Separator: “/” , “—”, “.” .

Curve Display

Detail Description of DataReport Control

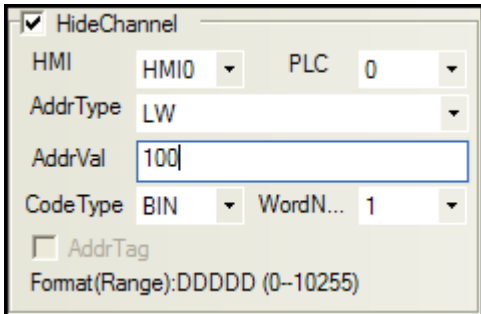
Property	Start from left
	Start from right
	Start from top
	Start from bottom
Sampling points	Sampling points on each page
Variable sampling points	Read number of sampling points on each page form specified address.
Hide Channel	<p>Set a specified register for hiding channels. Then set the corresponding bits to ON to hide the corresponding channels.</p> <p>Example: Check “Hide Channels” and set address to LW100. Then, when LW.B100.0=1, Channel 0 will be hidden; when LW.B100.1=1, channel 1 will be hidden; and so on.</p> 
Scroll	Use scroll to inquire sampled scale and time of the curve.

Example: Check “Scroll” , set Enable Scroll Address And Scroll Data Address to LB10 and LW10 respectively.

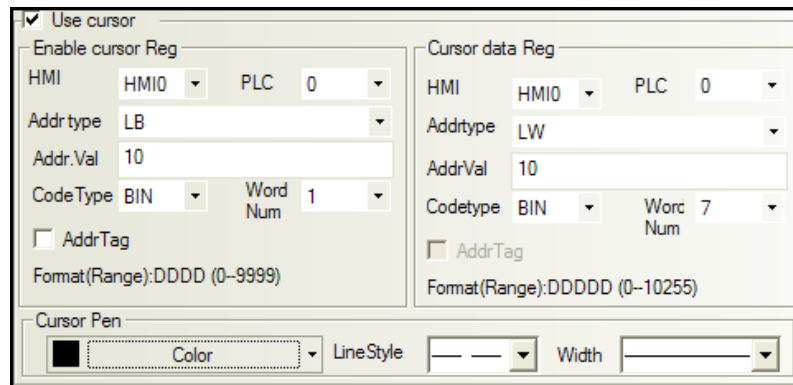

As following picture: Set Enable Scroll AddressLB0 to ON, then Scroll Data Address LW10, LW11, LW12, LW13, LW14, LW15 correspond to second, minute, hour, date, month, and year of the sampled data respectively. LW16 corresponds to data value of channel 0; LW17 corresponds to data value of channel 1, and so on.

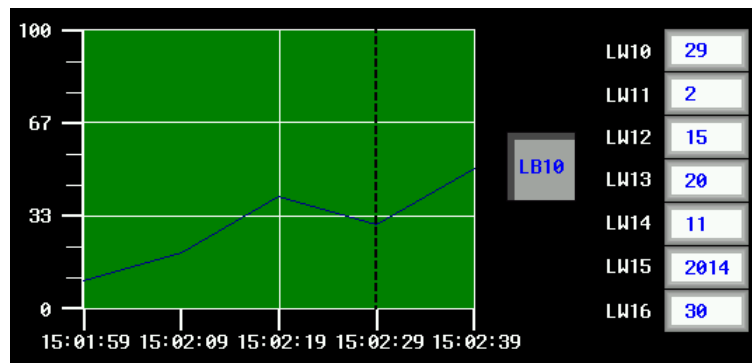

Scroll Brush

Set color, line style and width of scroll brush.

【Example】 Settings of Hide Channel and Scroll are as follows:

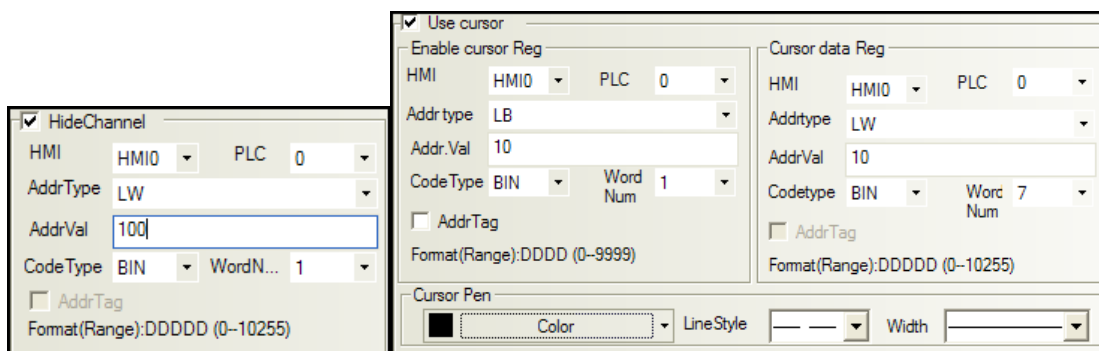

Set LW.B100.0 to ON, Channel 0 will be hidden; Set LW.B100.1 to ON, channel 1 will be hidden and so on.

Set LB10 to ON to enable scroll function. LW10, LW11, LW12, LW13, LW14, LW15 correspond to second, minute, hour, date, month, and year of the sampled data respectively. LW16 corresponds to sampled value of channel 0; LW17 corresponds to sampled value of channel 1, and so on.

Offline simulation:

Scroll inquiry:

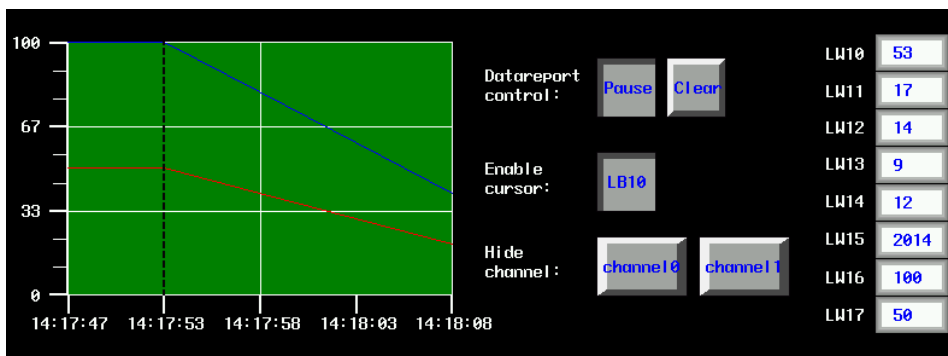

Hide Channel:

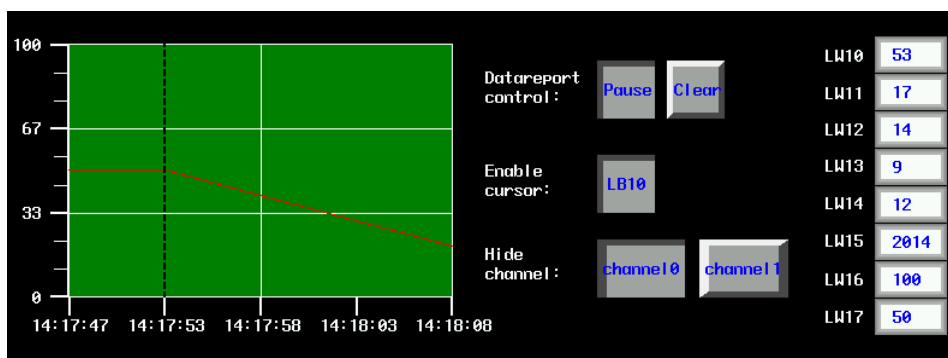

4.14 Data Transmission Component

Data Transmission component is used to exchange the data between HMI and PLC or controller. In Kinco HMIware, the following components can be used to exchange data: Recipe Data, Data Transmission, Data Transmission function in Timer and General PLC control in PLC Control component.

4.14.1 Recipe

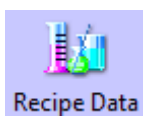

Recipe Data

Recipe Data component can transmit HMI data that can be stored even powered off to specified PLC/controller registers, or transmit data in PLC/controller data to HMI registers that can be stored even powered off.

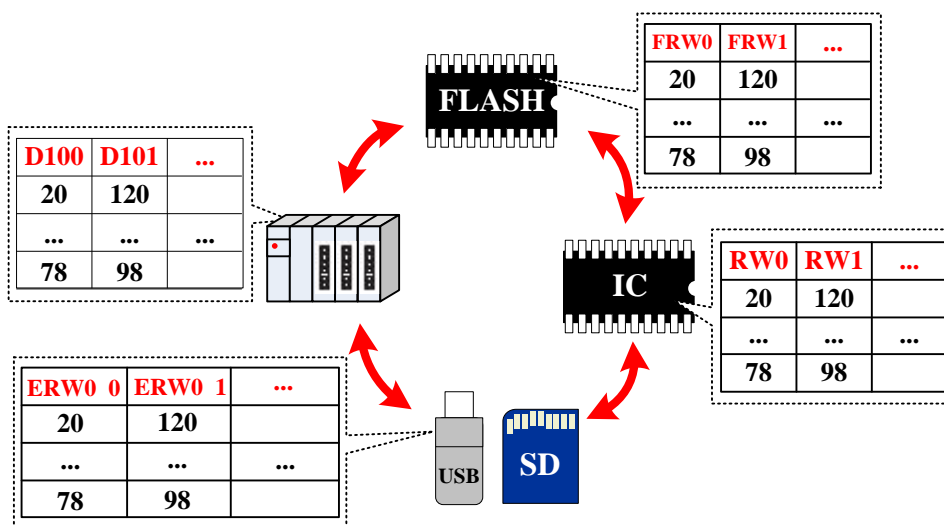



The Write Address of Recipe Data is the start register of transmitting PLC/controller

Recipe Data

Detail description of Recipe Data

Function	Upload from PLC to Recipe	Transmit data in specified PLC/controller registers to HMI RW registers
	Download from Recipe to PLC	Transmit data in HMI RW registers to specified PLC/controller registers
	Upload from PLC ERW0*1	Transmit data in specified PLC/controller registers to external memory device(the default is SD card)
	Download from ERW0 to PLC	Transmit data in external memory device (the default is SD card) to specified PLC/controller registers.
	Upload from PLC to ERW1*1	Transmit data in specified PLC/controller registers to external memory device(the default is USB DISK1)
	Download from ERW1 to PLC	Transmit data in external memory device (the default is USB DISK1) to specified PLC/controller registers.
	Upload from PLC to ERW2*1	Transmit data in specified PLC/controller registers to external memory device(the default is USB DISK2)
	Download from ERW2 to PLC	Transmit data in external memory device (the default is USB DISK2) to specified PLC/controller registers.
	Upload from PLC to FRW*2	Transmit data in specified PLC/controller registers to HMI FLASH memory FRW.
	Download from FRW PLC	Transmit data in HMI FLASH memory FRW to specified PLC/controller registers.
Data Length	The length of transmitting data, unit is word.	
Key	Map the function to the external keys (F1~F2) or HMI keys (F1~F8). The HMI with USB host slot or keys supports this function. The HMI with USB host or keys supports this function.	

*1.ERW0, ERW1, ERW2 are special registers for the external memory device, users can distribute them to U disk or SD card in the Extended Memory of the HMI Attributes

2. FRW is a special register type for the HMI flash memory.

For details, refer to [\[Advanced Part 11 Recipe/ Recipe Editor\]](#)

4.14.2 Data Transmission

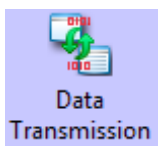

Data Transmission component transmits data in specified HMI or PLC/controller registers to the other HMI or PLC/controller registers. The transmission can be triggered by touching or change of specified register.

Basic Attributes

Basic Attributes of Data Transition			
Data Type	Set the transmitting data type: bit or word	Data Length	Set the transmitting data length
Key	Map the function to the external keys (F1~F2) or HMI keys (F1~F8). The HMI with USB host slot or keys supports this function. The HMI with USB host or keys supports this function		
Source Address	Set the source address of transmitting data		
Destination Address	Set the destination address of transmitting data		
Variable Parameters	The offset of Source Address, Destination Address and Data Length are read from specified registers		

Take the following picture for example, the Source Address, Destination Address and Data Length use variable parameters, set the D register (PLC register) for Source Address, and the LW100 (HMI register) controls the offset of Source Register; Set LW register (HMI register) for Destination Address, and the LW101 (HMI register) controls the offset of Destination Register; LW103 controls the Data Length.

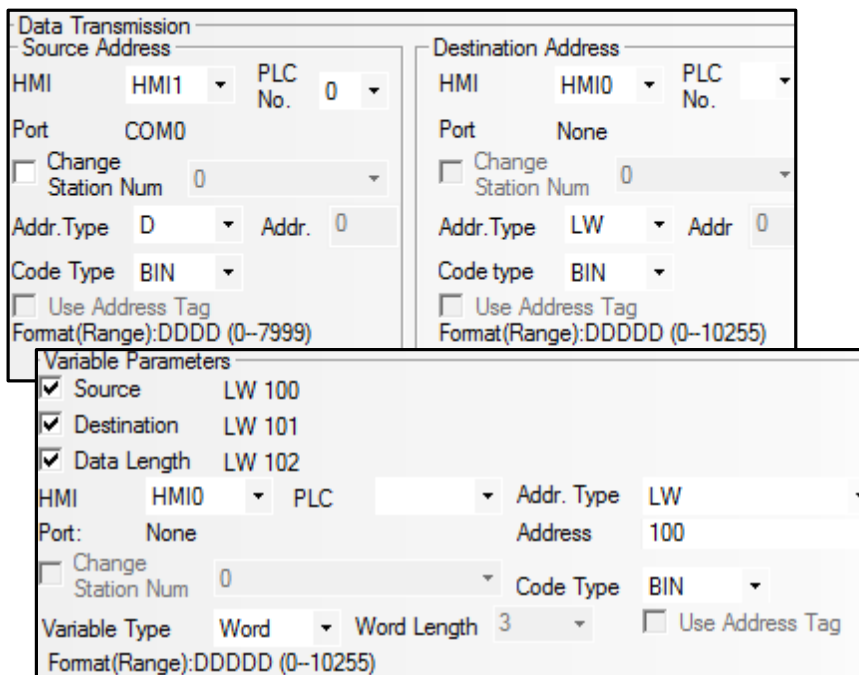

When the offset of Source Address is 0, offset of Destination Address is 0 and the Data Length is 1:

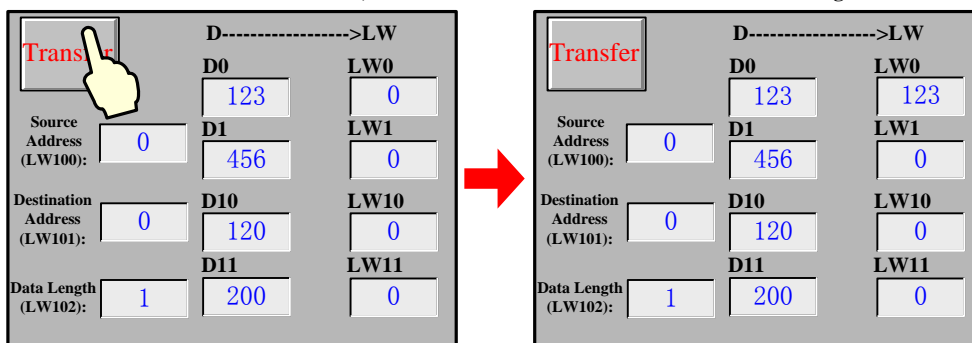

When the offset of Source Address is 10, offset of Destination Address is 10 and the Data Length is 2:

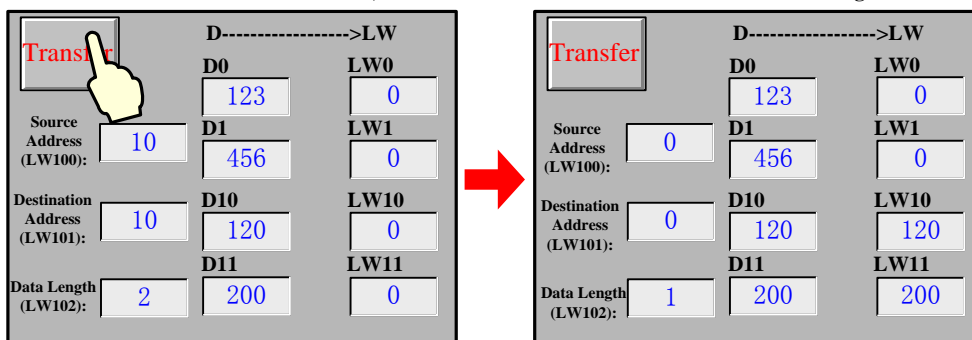

Trigger Address

Check the “Use Trigger Address” in Trigger Address page to trigger the transmission by status of specified register.



If use the trigger address to trigger the transmission but not by touch, user can set the **Always Invalid** in the Control Setting page.

Detail Description of Trigger Address

Trigger Type	Description
OFF→ON	When specified register changes from OFF to ON, the transmission is triggered
ON→OFF	When specified register changes from ON to OFF, the transmission is triggered
OFF↔ON	When specified register changes its status, the transmission is triggered
OFF→ON (Reset)	When specified register changes from OFF to ON, the transmission is triggered, at the same time reset the trigger address
ON→OFF (Reset)	When specified register changes from ON to OFF, the transmission is triggered, at the same time reset the trigger address

4.15 Project Database

In Kinco Builder, user can put the repeat information or background function in the specified area, in this way, it is easy to

control and call this information and function, at the same time it can reduce the data redundancy. The specified area are in the project Data Base components, they are: Text Library, Address Tag, Alarm Information, Event Information, PLC Control, Sound Lib and so on.

4.15.1 Text Library

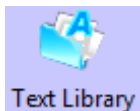

Text Library component is used to store the text content in the project, so that it can avoid the input the same text tag many times. Text Library supports multiple language, it makes the HMI can switch the display languages. Kinco HMIware supports 32 languages switching at most.

● Text Library Interface

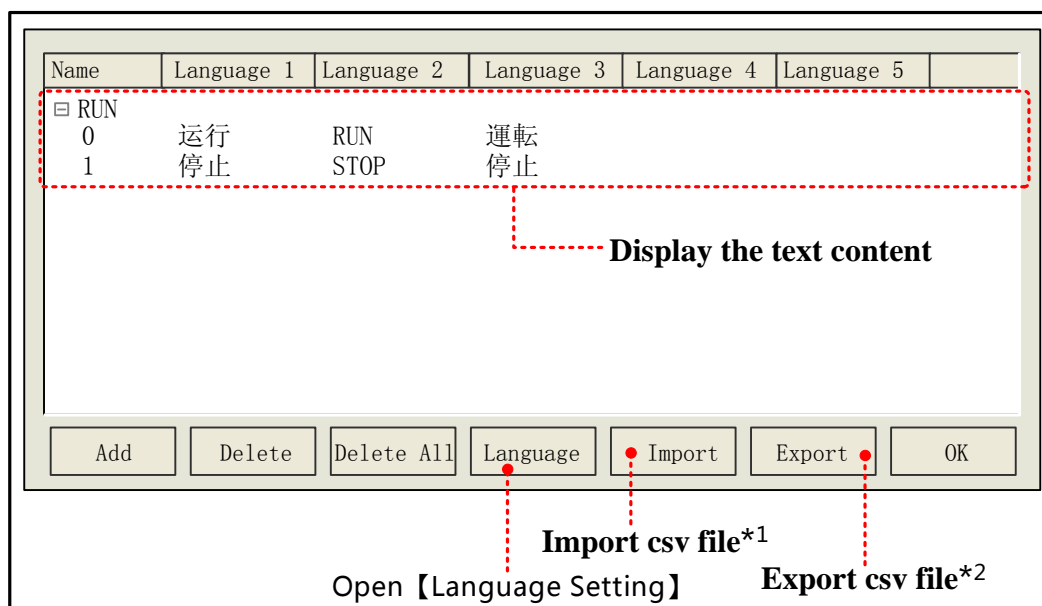

*1. Import csv file (text library file) to Text Library of current project

2. Export the Text Library to the CSV file, User can use Microsoft EXCEL to open and edit this CSV file.

Language attributes

Click the Language in the Text Library to open the Language Setting dialog box, in this dialog box, user can set the font attributes of each language, refer to the following table for details:

Description of Language Setting	
Max Lang Num	Text Library supports 32 different languages setting at most; the default max language number is 8. Note: If customer needs to display more than 8 languages, he should set the Max Lang Num.
Current Lang	Choose the current language.
Font Type	Choose the data type for current language: Vector Font or Dot Matrix Font.
Font Attribute	Set the font attributes of current language: Size, Alignment, Color, Italic/Bold and so on.
Copy Font Attribute to All Language	Copy the current font attributes to the font of all the languages.
Language	It is related to the OS and input method, take Windows XP for example, if user wants to add the English (America) and Japanese language, click the  on the system language bar, then choose

the “set” to add English(America) and Japanese as the following picture.

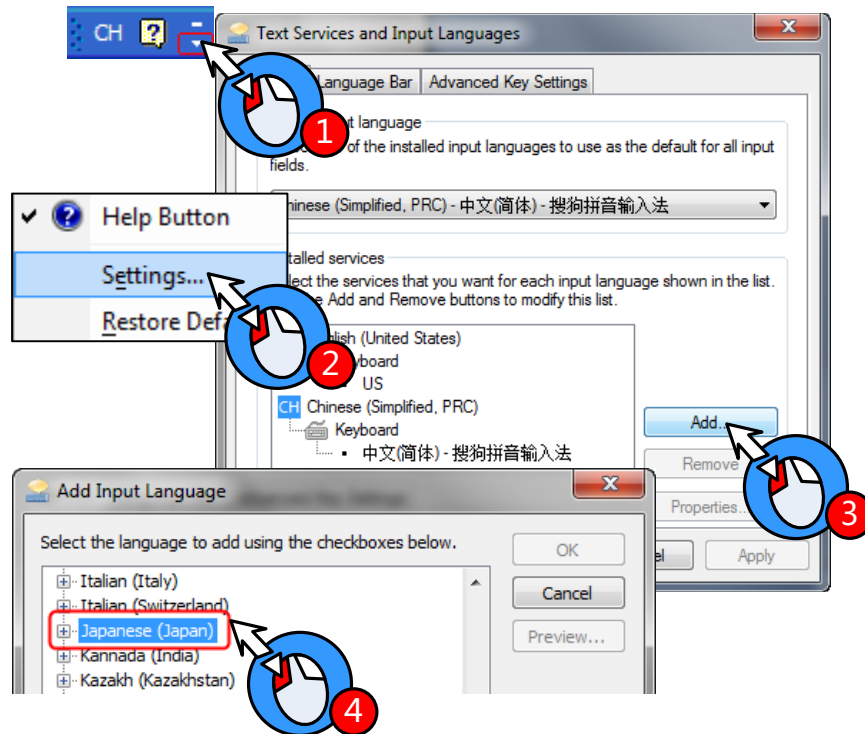

After add the English(America) and Japanese languages, user can find the English(America) and Japanese in the dropdown menu of Language

[For details, refer to \[Advanced Part 5.1 Text Library\]](#)

4.15.2 Address Tag

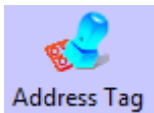

Address Tag component can be used to store the address information , and user can add description to these addresses.

● Tag Address Interface

Name	HMI No.	PLC No. :Station No.	Date Type	Address Type	Address
Motor Run	HMI0	PLC0:0	Bit	M	0
Rate Set	HMI0	PLC0:0	Word	D	0

Display the address information

Import csv file*1 Export csv file*2

- *1. Import the address information (CSV file) to the Address Tag.
- 2. Export the address information of Address Tag to a CSV file, user can use Microsoft EXCECEL to pen an edit this CSV file.

Build Address Tag attributes

Click the Add in Address Tag to open the Build Address Tag box, see the following table for details:

Description of Build Address Tag	
Tag Name	Set the name of this address tag.
HMI	Choose the HMI number of this address tag.
PLC NO.	Choose PLC/controller number of this address tag.
Data Type	Choose the data type: word or bit.
Address Type	Choose the address type of address tag, it can be HMI register or PLC/controller register.
Address	Set the address of address tag.
Code Type	Display the code type of address tag: BIN or BCD
Format(range)	Display the address format and address range.

[For details, refer to \[Advanced Part 5.2 Address Tag Library\]](#)

4.15.3 Event Information

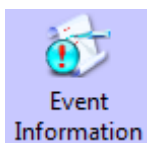

Event Information is used to configure the event content and trigger conditions; it is used with the Event Display and Event Bar together. Event Information supports bit register and word register to trigger event.

[For details about Event Display and Event Bar, refer to \[Advanced Part 4.7 Alarm Component\]](#)

● Event Information Interface

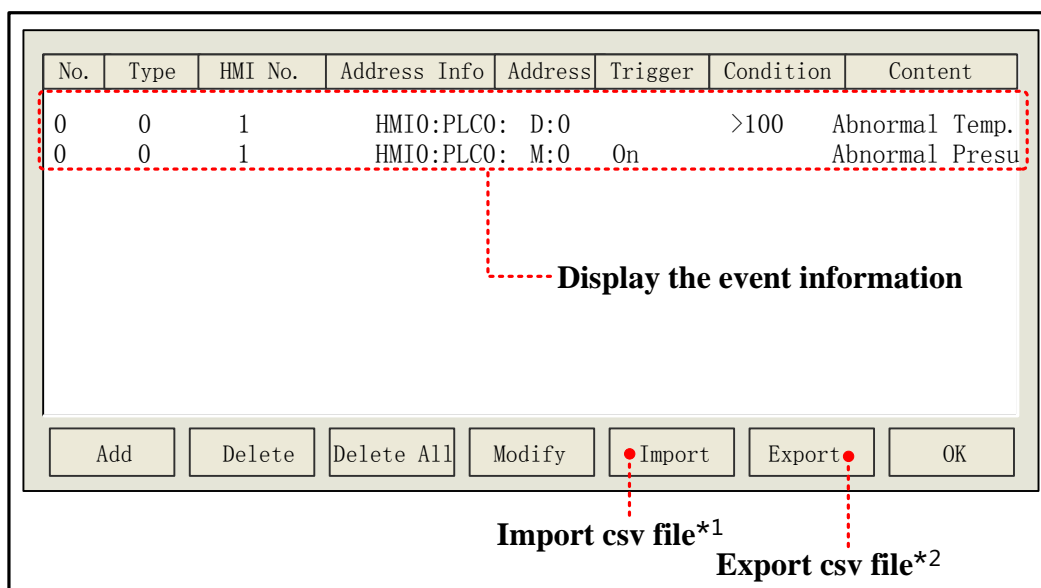

- *1. Import the event information (in CSV file) to the Event Information library.
- 2. Export the event information to a CSV file, user can use Microsoft EXCECEL to pen an edit this CSV file.

Event Attributes

Click the Add in the Event Information to open the Event attributes dialog box, see the following table for details:

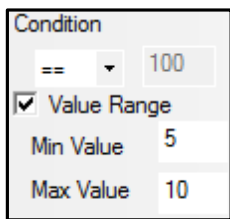
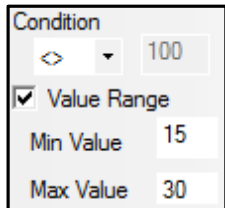
Triggered HMI	In multiple HMI program, set the HMI where the Event Display or Event Bar displays this event information.	
Type	Set the event type: 0~255 are optional. Event Display and Event Bar can display the event information conditionally according to the event type.	
Address	Set the read address of trigger register, choose the bit or word type in Data Type.	
Attributes		
Bit	On	When specified bit register' s status changes from OFF to ON, an event log will be generated.
	Off	When specified bit register' s status changes from ON to OFF, an event log will be generated.
Word	<	When the value in specified register smaller than the specified value, an event log will be generated.
	>	When the value in specified register larger than a specified value, an event log will be generated.
	=	When the value in specified register equals the specified value, an event log will be generated. Value Range: When the value in specified register equals is in the specified value range, an event log will be generated. Take the following picture for example, check the “Value Range” , set 5 to the Min Value and 10 to Max Value , suppose the data in specified register is N , if $5 \leq N \leq 10$, an event log will be generated.
	==	
	<>	When the data in specified register is not equal to the set value, an event log will be generated. For example, check the “Value Range” , set the Min Value to 15, set the Max Value to 30, suppose the data in specified register is N , if $N < 15$ or $N > 30$, an event log will be generated.
	<>	
	<=	When the data in specified register is less than or equal to the set value, an event log will be generated.
	>=	When the data in specified register is more than or equal to the set value, an event log will be generated.
Print	Configure the Event Printing in the Printing Setting of HMI Attributes.	

Print Setting of Event Display	
<input type="checkbox"/> Print Sequence No.	<input type="checkbox"/> Network Printing
<input type="checkbox"/> Print Time	<input type="checkbox"/> Print Date
<input type="checkbox"/> Print Extended Time(d:h:m)	<input type="checkbox"/> Print Extended Date(yyyy/mm/dd)
<input type="checkbox"/> Print Standard Time(h:m:s)	<input type="checkbox"/> Check Window Errors
<input type="checkbox"/> Print Precise Time(h:m:s.ms)	

 For details, refer to [Advanced Part 6.1.8 Print Setting]

On Trigger

Print the event when event is triggered.

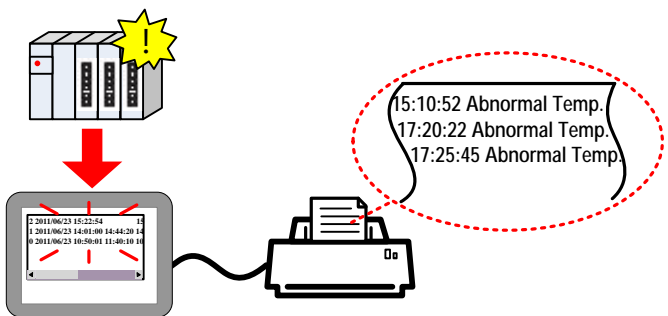

Return to Normal

Print the event when the event returns to normal.

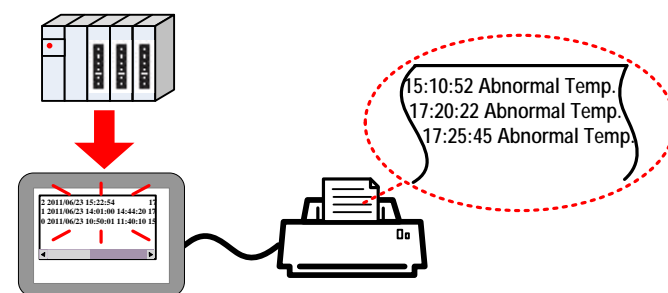

Trigger Function

Execute Macro

The specified macro is triggered when the event happens.

Pop-up Window

Confirm Pop

When the event is touched in the Event Display component, pop up specified window.

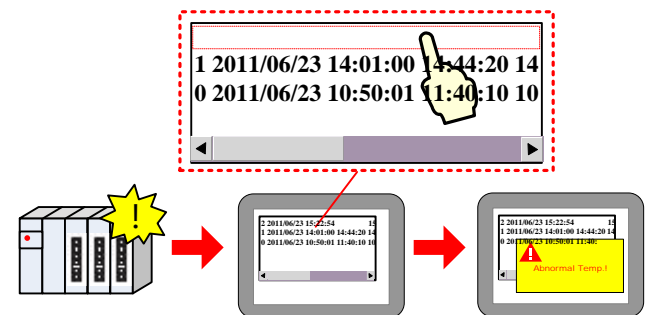

Note: please use the “Close window” function in Function Key to close the pop-up window.

Trigger Pop

When the event is triggered, pop up specified window.

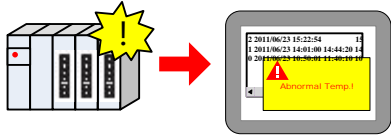
	 <p>Note: please use the “Close window” function in Function Key to close the pop-up window.</p>
--	---

Write Data	Word length is 3. Write (Trig) address is the specified address; Write (Confirm) address is the specified address+1; Write (Resume) address is the specified address+2;		
	Write(Trig)	0	When the event happens, set OFF to specified register.
		1	When the event happens, set ON to specified register.
		Not	When the event happens, reverse specified register status.
	Write(Confirm)	0	When the event confirm, set OFF to specified register.
		1	When the event confirm, set ON to specified register.
		Not	When the event confirm, reverse specified register status.
	Write(Resume)	0	When the event resume, set OFF to specified register.
		1	When the event resume, set ON to specified register.
Not		When the event resume, reverse specified register status.	

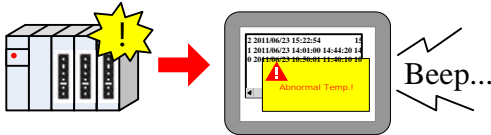
User Buzzer	<p>When the event happens, trigger the buzzer. Buzzing Time ranges from 1 to 65535, the units is second.</p> 
-------------	--

Text

Input text content that needs to be displayed in Event Display after event happens, click the Font to set the font attributes.

Data in LW register can be displayed in the event information, user can configure it according to the following format:

^xxx^: Print header, which means print this content when the event is triggered the first time or a different event is triggered.

For example, print “water” as a header, the format is ^water^

%h:mm:s#: Print time;

%y:mm:d#: Print date;

%nnfmd: Print variable, % means the start sign, nn means register number of LW, ranges from 00 to 99, that is to say , it is from LW0 to LW99, f means there is decimal in the data , d means the end sign. If there is no decimal in the data, the format can be %nnd. Take printing the data in LW20 for example; there is a decimal in this data, use the %20f1d in the Text of the Event Information. **Note:** If customer wants to print data in PLC register, use the Timer to transmit the dat to LW0~LW99.

Use Text Library	The Text content reads from the text library, but not writes in the text box.
	For details, refer to [Advanced Part 4.15.1 Text Library]
Use Graph Font	Set the graph font for the text content in event display, user can set the font attribute after the “Use Graph

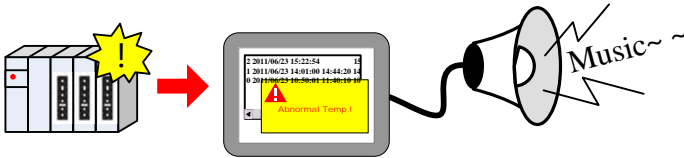
	Font” is checked.
Language	When multiple languages is used in Text Library, user can choose language then set the font attributes of this language.
Sound	
Select Sound	<p>Play selected audio file when this event is triggered.</p>  <p>Note: Only the HMI with audio output port supports this function.</p> <p>For details, refer to [Advanced Part 4.15.6 Sound Lib]</p>
Open Text Library	Open the Text Library dialog box.
Open Address Tag Library	Open the Address Tag dialog box.

4.15.4 Alarm Information



Alarm Information is used to configure the alarm content and trigger conditions; it is used with the Alarm Display and Alarm Bar together. Alarm Information only supports bit register to trigger alarm.

[For details, refer to \[Advanced Part 4.7 Alarm Component\]](#)

Alarm Information

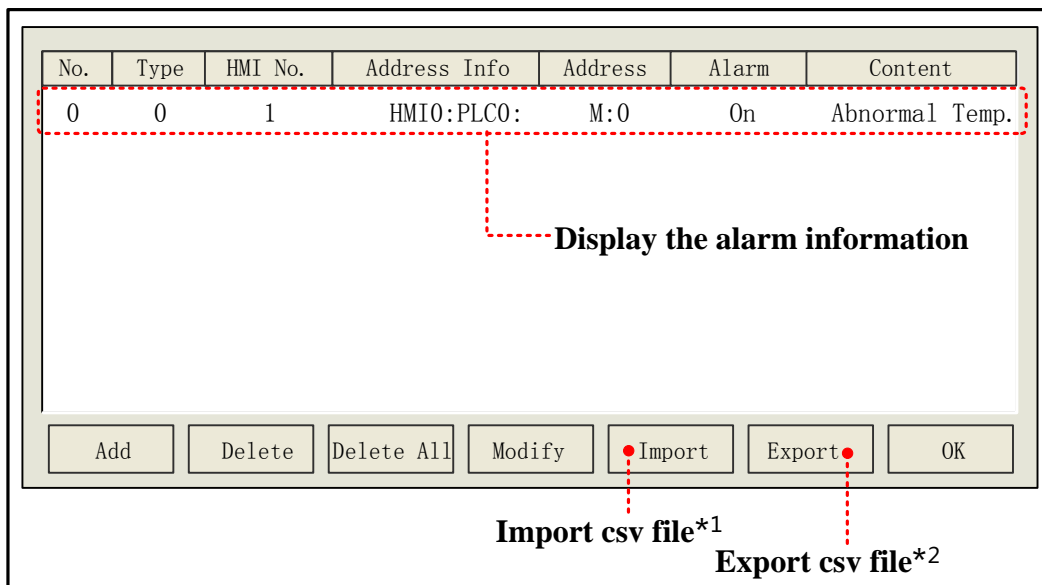

- *1. Import the alarm information (in CSV file) to the Alarm Information library.
- 2. Export the alarm information to a CSV file, user can use Microsoft EXECCEL to pen an edit this CSV file.

Alarm Attributes

Click the Add in the Alarm Information to configure the alarm information, see the following table for details:

Triggered HMI	In multiple HMI program, set the HMI where the Alarm Display or Event Bar displays this alarm information.
Type	Set the event type: 0~255 are optional. Alarm Display and Alarm Bar can display the event information conditionally according to the event type.
PLC Address	Set the read address of trigger register, supports bit address only.
Use Address Tag	Use the address in the Address Tag library.
Address Tag Library	Open the Address Tag library dialog box.

Attributes

Trigger	On	When specified bit register changes from OFF to ON, an alarm log is generated.
	Off	When specified bit register changes from ON to OFF, an alarm log is generated.
User Buzzer	When the alarm is triggered, the buzzer will be buzzing. Buzzing Time: 1~65535 are optional , the units is second.	

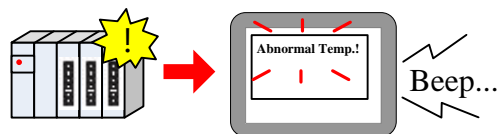

Text

Input the displaying constant when the alarm is triggered; click the Font to set the font attributes.

Use Text Library	The Text content reads from the text library, but not writes in the text box. For details, refer to [Advanced Part 4.15.1 Text Library]
Use Graph Font	Set the graph font for the text content in event display, user can set the font attribute after the “Use Graph Font” is checked.
Language	When multiple languages is used in Text Library, user can choose language then set the font attributes of this language.

Sound

Select Sound	Play selected audio file when current alarm is triggered.
--------------	---

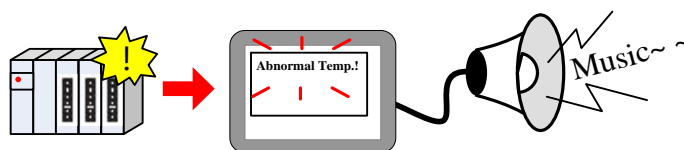

Note: Only the HMI with audio output port supports this function.

[For details, refer to \[Advanced Part 4.15.6 Sound Lib\]](#)

Text Library	Open the Text Library dialog box.
--------------	-----------------------------------

4.15.5 PLC Control

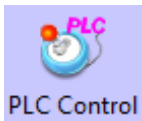

PLC Control is used to log in the trigger condition of some functions, when specified register satisfies the setting condition, the corresponding function will be executed.



The function in PLC Control will not be limited by window, the function will execute as soon as the condition is satisfied.

- PLC Control Interface

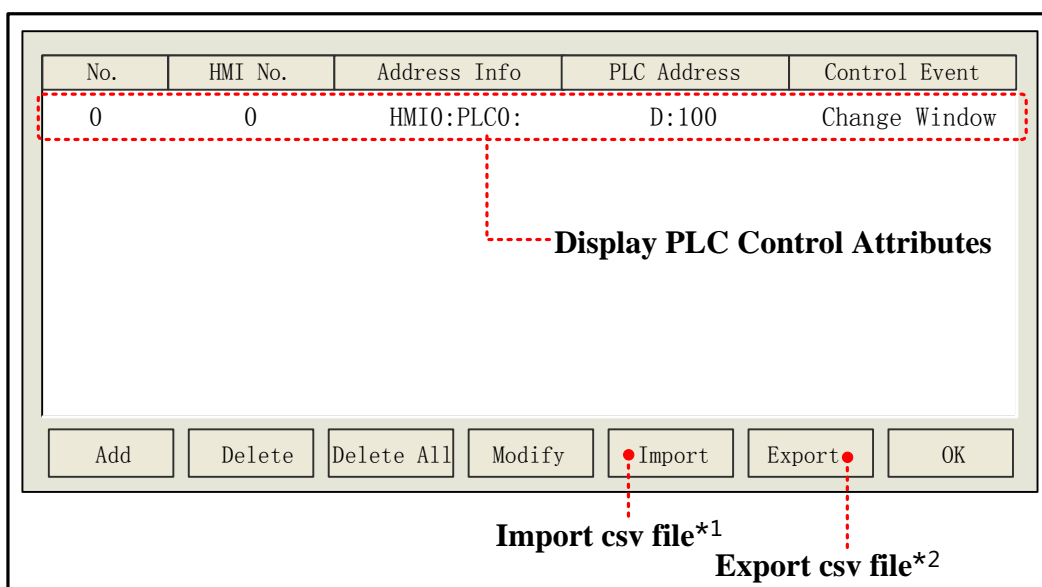

*1. Import the control file constant (in CSV file) to the PLC Control library.

2. Export the control file constant to a CSV file, user can use Microsoft EXECCEL to pen and edit this CSV file.

Alarm Attributes

- PLC Control Attributes

Click the Add in the PLC Control to open the dialog box, chose the control function in the Control Type and set the control register and trigger condition.

The control type that PLC Control supports are as followings: Change Window (Ignore the window 0), Write Data to PLC (Current Base Window number); Report Printout; Screen Hard Copy; General PLC Control; General PLC Control(Extended); Backlight Close; Backlight Close (Write Back); Execute Macro Program; Backlight Open; Backlight Open(Write Back); Sound Ctrl; Save Screen Shoot Data to Extended Memory.

See the following for details of the control type.

(1) Change Window

When the value in specified register changes to a valid window number, HMI will switch to the window with this window

number automatically. And write the new window number to the specified register+1 address.

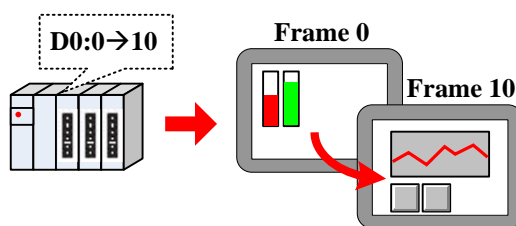

For example, Suppose the current window number is 0, specified register address is D100, when the D100 is 10, the HMI switches to the window 10, and return the new window number 10 to D101.



If the “Change Window” in PLC Control and “Change Common Window” in Function Key are used at the same time, user can set an invalid window number to the control register by “Set at Window Close” of Multiple State Setting component, in this way to avoid inputting the same window number, but cannot change the window at the next time.

(2) Change Window (Ignore the window 0)

Change common window function, when the value in specified register is 0, HMI will not change to Window 0.

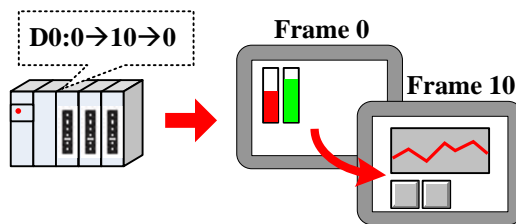

(3) Write Data to PLC (Current Base Window)

When switching common window, write the window number to specified register.

(4) Report Printout

Print the HMI screen according to the value in the specified register. When value in specified register changes and this value is a valid window number, the constant in this window will be printed out.

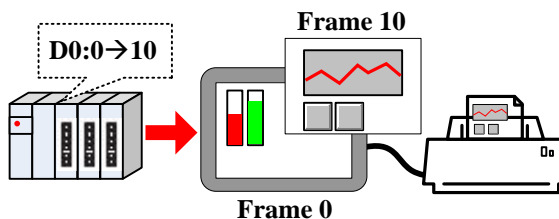

1. HMI will not switch to the printed window when printing out this window in Print Out function.
2. The data in specified register will be reset to 0 automatically after printing.
3. Report Printout cannot print the constant in window 0.

User can set the printing constant by the following two methods:

Method 1: Check the Custom Print Options

Attributes of Custom Print Options

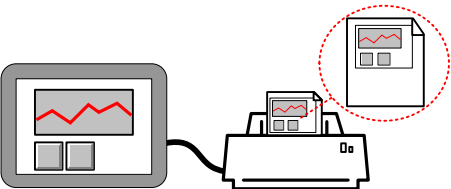
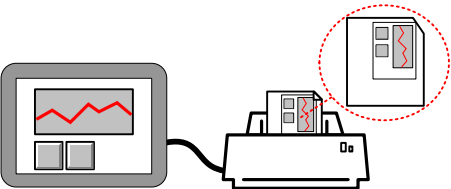
Custom Print Attributes		Detail Description
Printer Color	Monochrome	Only the color printer supports switching printer color.
	Color	
Magnification	Ranges from 0.1 to 5.0(Zoom-out printing may causes anamorphous, we do not advice zoom-out printing.)	
Print Page	Current Page	Start the printing at the first paper in printer.
	Change page to print	Print a blank paper first, and then start the HMI screen printing.
	Horizontal print	Print the screen horizontally. 
	Vertical print	Print the screen vertically. 
	Automatically Take The Paper	Print a whole paper automatically when finishing the printing. This option is only suitable for the stylus printer, micro printer does not support, and laser printer has this setting itself, user needs not to set on HMI.
	Print Text	Print the static text and tag text of current window.
Print Text	Print Meter	Print meter component in current window.
	Print Trend Curve	Print trend curve component in current window.
	Print Bit Map	Print bit map component in current window.
	Print All The Vector Graph	Print all vector graph component in current window.
	Print Background Color	Print meter component in current window.

Method 2: Do not check the Custom Print Options; use the bits of LW9054 and LW9055 to set the print.

LW9054 Setting			
Bit No.	Name	0 (OFF)	1 (ON)
Bit0	Print Text	Do not print	Print
Bit 1	Print Meter	Do not print	Print
Bit 2	Print Trend Curve	Do not print	Print

Bit 3	Print Bit Map	Do not print	Print
Bit 4	Print All The Vector Graph	Do not print	Print
Bit 5	Print Background Color	Do not print	Print



Use the Multiple States Setting component to set the value of LW9054, if all the constant needs printing, put the Multiple State Setting component in the common window(frame 1) and the setting mode is Set at Window Open, set value is 255.

LW9055 Setting			
Bit NO.	Name	0 (OFF)	1 (ON)
Bit 0~ Bit 7	Magnification	Each bits means zoom out 0.1 times	Each bits means zoom in 0.1 times (LW9055 ranges from 1 to 50, which means 0. 1 to 5 times.)
Bit 8	Printer Color	Color	Monochrome
Bit 9	Print page	Current page	Change page to print

For example, if the Magnification is 0.3, Monochrome printing and print current page, that is to say, set the LW.B9055.0, LW.B9055.1, LW.B9055.8 and LW.B9055.9 On. User also can set the above configuration by LW9055 directly, set LW9055 to 259(bit 0, 1, 8 and 9 on means 259)

[For details, refer to \[Advanced Part 13.3 Print Function Setting Method\]](#)

(5) Screen Hard Copy

Screen Hard Copy is used to print current screen: when the specified bit register changes from OFF to ON, the current screen is printed.

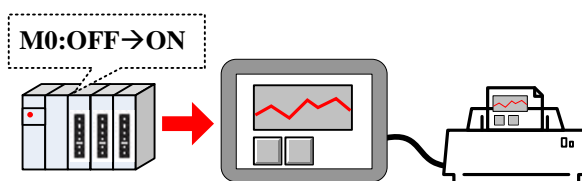

The Custom Print Options setting is the same as the Report Printout.

(6) General PLC Control

General PLC Control is used to transmit data between PLC/controller registers and HMI local registers.

When the Control Type is General PLC Control, system will distribute 4 registers to control transmit type, transmit data length, offset of PLC/controller register address and offset of HMI register address. See the following table for details:

Address	Function	Description
Specified address	Store the transmit type code, different codes mean different transmitting direction.	There are 4 transmit type, see details in table 4.15.5_5, when the register is write new code, HMI executes corresponding transmit and the register will be reset to 0

		after the transmitting finishes.
Specified address+1	Data length	The transmitting data length, units is word.
Specified address+2	offset of PLC/controller register address	This offset is for the “specified address +4” .
Specified address+3	offset of HMI register address	Set the start address of HMI recipe register(RW) or local register(LW).

See the following table for details of transmit type.

Code	Data transmit type	Code	Data transmit type
1	PLC → RW(HMI Recipe register)	2	PLC → LW(HMI local register)
3	RW(HMI Recipe register) → PLC	4	LW(HMI local register) → PLC

For example: Transmit the data in D100~D104 (PLC register) to the RS100 ~RW104 (HMI recipe register).

Set D0 as the specified address in PLC Control, that is to say, D0 controls the Transmit Type, D1 controls the Transmit Data Length, D2 controls the offset of data source register (PLC) and D3 controls the offset of destination register (HMI). According to the example, D0=1 means transmit data from PLC to RW; D1=5 means there are 5 words (D100~D104) needs transmitting; D2=96 which means PLC source address is $D100=(96+0)+4$, 0 means the start address in General PLC Control. As the D0 to D3 are used for control register, so the source address is D4 , and the offset(96) is also for D4 , so the PLC source register address is $D2+$ start address in General PLC Control(D0)+4. D3=100 means that the start address of destination register is RW100.

(7)General PLC Control (Extend)

General PLC Control (Extend) is similar as the General PLC Control, it is also used to transmit data between PLC/controller register sand HMI registers; the difference is that it distributes 6 registers to transmit type, transmit data length, offset of PLC/controller register address and offset of HMI register address. See the following table for details

Address	Function	Description
Specified Address	Store the transmit type code, different codes mean different transmitting direction	There are 4 transmit type, see details in table 4.15.5_5, when the register is write new code, HMI executes corresponding transmit and the register will be reset to 0 after the transmitting finishes
Specified Address+1	Data length	The transmitting data length, units is word
Specified Address+2	offset of PLC/controller register address	This offset is for the “specified address +6”
Specified Address+4	offset of HMI register address	Set the start address of HMI recipe register (RW) or local register(LW)

(8) Backlight Close

When the specified bit register changes from OFF to ON, HMI turns off the backlight, and the backlight will be on again if the screen is touched.

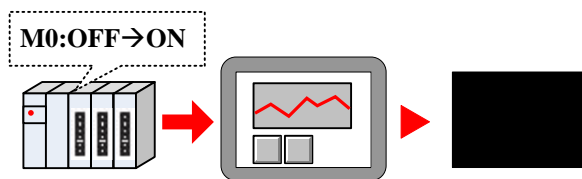

(9) Backlight Close(Write Back)

When the specified bit register changes from OFF to ON, HMI turns off the backlight, and reset the specified register to OFF. The backlight will be on again if the screen is touched.

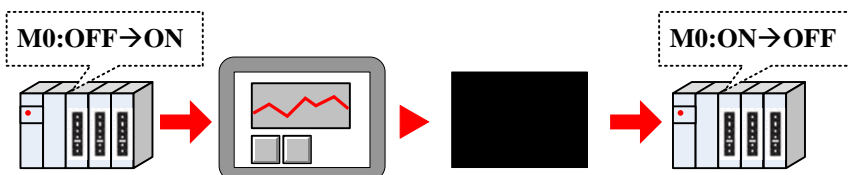

(10)Execute Macro Program

When the specified register satisfies the execute method, the specified macro will be executed.

The execute methods are as follows:

Execute Method	Description
ON←→OFF	When the status of specified register changes, HMI executes specified macro
OFF→ON	When the status of specified register changes from OFF to ON, HMI executes specified macro
ON→OFF	When the status of specified register changes from ON to OFF, HMI executes specified macro
ON	When the status of specified register keeps ON, HMI executes specified macro
OFF→ON, reset	When the status of specified register changes from OFF to ON, HMI executes specified macro At the same time reset the specified register to OFF automatically
ON→OFF, reset	When the status of specified register changes from ON to OFF, HMI executes specified macro At the same time reset the specified register to ON automatically

(11) Backlight Open

When the specified register changes from OFF to ON, HMI will turn on the backlight.

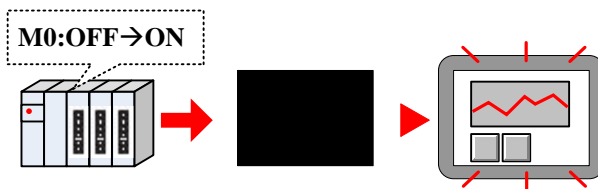

(12) Backlight Open (Write Back)

When the specified register changes from OFF to ON, HMI will turn on the backlight. At the same time HMI resets the register to OFF.

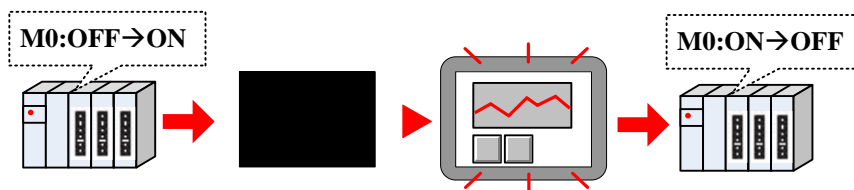

(13) Sound Control

When the specified register satisfies the setting condition, HMI plays specified audio file.

Execute Method	Description
ON←→OFF	When the status of specified register changes, HMI plays specified audio file
OFF→ON	When the status of specified register changes from OFF to ON, HMI plays specified audio file
ON→OFF	When the status of specified register changes from ON to OFF, HMI plays specified audio file
OFF→ON, reset	When the status of specified register changes from OFF to ON, HMI plays specified audio file At the same time reset the specified register to OFF automatically
ON→OFF, reset	When the status of specified register changes from ON to OFF, HMI plays specified audio file At the same time reset the specified register to ON automatically

[For details, refer to \[Advanced Part 5.4 Sound Lib Application\]](#)



Only the HMI with audio output port supports this Sound Control function

(14) Save Screenshot Data to Extended Memory.

When specified register changes from OFF to ON, save the current screen constant to the extended memory in picture.

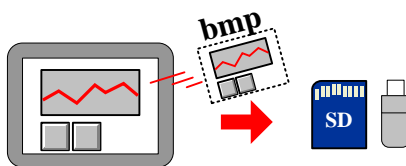

1. Only the HMI with USB host and SD card supports this function
2. This function supports offline simulation, indirect online simulation and direct simulation. The screenshot pictures are saved in the `\disk\sd(usb1 or usb2)\scr` file folder of Kinco HHMIware installation route

User needs to set the extended device in the HMI Attributes>>> HMI.



The bmp pictures are named as year-month-day, hour: minute: second: millisecond, for example: 2010-09-01, 10:12:50:203.bmp. User also can define the picture name by system special register. The LW9470~LW9485 define the prefix of file name, for example the constant in LW9470~LW9485 is “Version Num .20100001-” , then the screenshot picture name is Version Num .20100001-2010-09-01,10:15:28:421.bmp.



After the save screenshot is executed, please do not plug out the extended memory device in 1 minute, or the picture may cannot be saved.

4.15.6 Sound Lib

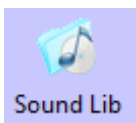

Sound Lib is used to save the wav or mp3 audio file. The system will transfer the audio file to snd format file automatically, and user can call this file, the original audio file (WAV or mp3 file) are saved in the sound file folder of current project.

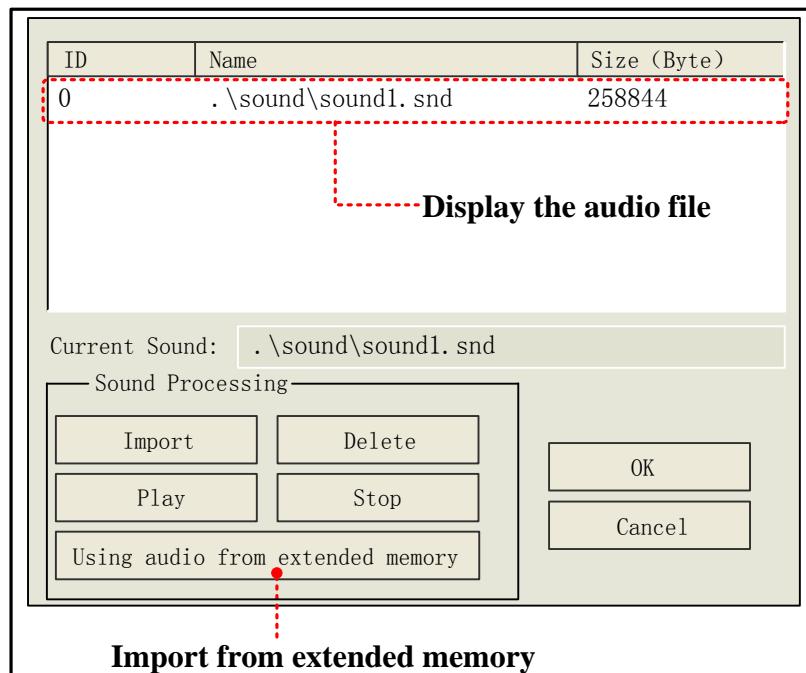

1. One imported audio file must be smaller than 256KB, but the audio file from the Using audio from extended memory does not limit the file size.
2. Supports WAV, MP3 format audio file.

[For details, refer to \[Advanced Part 5.4 Sound Lib Application\]](#)

4.15.7 Data Logger

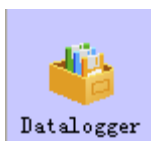

Data Logger is used to sample data and set sampling method, these data can be displayed on Data Report component.

● Interface of Data Logger

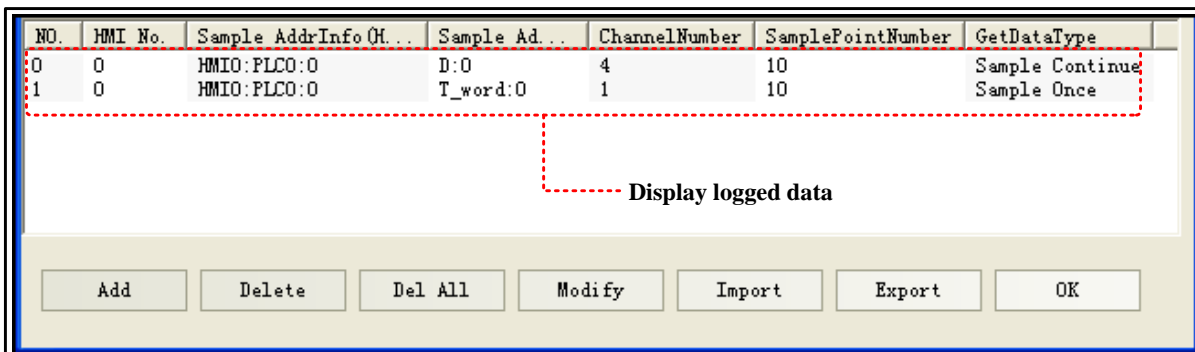

- Import:** Import the data sampling information in CSV file format to the Data Logger
- Export:** Export all logged in sampling data to a CSV file; this file is editable by Microsoft EXCEL.

● Data Logger Attributes

Click the **Add** to open the Data Logger attributes dialog window, the detail attributes are as follows:

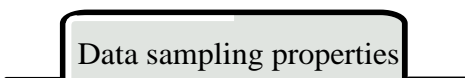

Detail Description of Data sampling properties.		
Sample Point	The total sample point number, it ranges from 1~999999	
Sample Type	Circle Sampling	Sample the data periodically.
	Trigger Sampling	Trigger sampling when the specified register satisfies the condition.
Get Datatype	Sample Continue	The sampling continues even if all the sampling points are finished.
	Sample Once	The sampling stops when all the sampling points are finished, that is to say , the sampling is executed only once.
Channel	The continuous sampling registers number, 16 channels at most.	
Circle Sample Param	It is invalid if the Sampling Type is Circle Sampling.	
	Sample Circle	The time interval between each two sampling points, the unit is millisecond.
	Viable Circle	Read sample circle from specified register in circle sampling.
Trigger Type	It is invalid if the Sampling Type is Trigger Sampling.	
	OFF→ON	Only when the specified register changes from OFF to ON, HMI triggers the sampling..
	ON→OFF	Only when the specified register changes from ON to OFF, HMI triggers the sampling..

	OFF←→ON	Only when the specified register changes its status, HMI triggers the sampling..
	OFF→ON(reset)	Only when the specified register changes from OFF to ON, HMI triggers the sampling, and then reset the specified register automatically.
	ON→OFF(Reset)	Only when the specified register changes from ON to OFF, HMI triggers the sampling, and then reset the specified register automatically.
Sample Channel	Data Type	Set the display data format for the sampling data, there are six formats , they are 16-bit signed, 16-bit unsigned, 32-bit signed, 32-bit unsigned, float, double and string.
	Description	Set the description name for the channel



If the Variable Circle is checked, the variable value is used preferentially, if the variable value cannot be get because of communication lost , HMI uses the default value(the Sample Circle) .

Data Sample Control

Detail Description of Data Sample Control

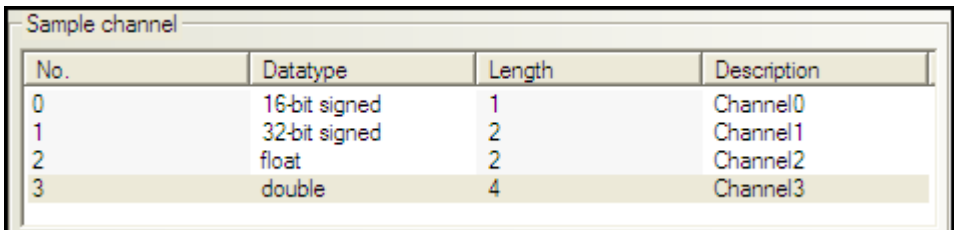
Sample Address	Set the start address of sampling data, the word length depends on the channel and data type. Take the following picture for example: there are 4 channels, their data types are 16-bit signed, 32-bit signed, float and double. So the word length is 9, because the 16-bit signed is one word, 32-bit signed is two words; float is two words and double is 4 words.																					
	 <table border="1" data-bbox="395 1223 1353 1451"> <thead> <tr> <th>No.</th> <th>Datatype</th> <th>Length</th> <th>Description</th> </tr> </thead> <tbody> <tr> <td>0</td> <td>16-bit signed</td> <td>1</td> <td>Channel0</td> </tr> <tr> <td>1</td> <td>32-bit signed</td> <td>2</td> <td>Channel1</td> </tr> <tr> <td>2</td> <td>float</td> <td>2</td> <td>Channel2</td> </tr> <tr> <td>3</td> <td>double</td> <td>4</td> <td>Channel3</td> </tr> </tbody> </table>		No.	Datatype	Length	Description	0	16-bit signed	1	Channel0	1	32-bit signed	2	Channel1	2	float	2	Channel2	3	double	4	Channel3
No.	Datatype	Length	Description																			
0	16-bit signed	1	Channel0																			
1	32-bit signed	2	Channel1																			
2	float	2	Channel2																			
3	double	4	Channel3																			
Sample Data Save	Save Disk	The external memory device of HMI, the SD Card, USB1 and USB2 are optional.																				
	Save Dir	The subdirectory where sampling data is saved in the external memory device. The default name is SampleDataStore, customers can change this name themselves, and the detail route of this file is \external device\database\subdirectory name\export file name.db. The file format is .db.																				
	Variable Dir	The subdirectory name is read from specified register, the max word length is 16.																				
Sample Data Clear	Use a bit register to clear the sample data and delete the file in the database.																					
	OFF→ON	Only when the specified register changes from OFF to ON, HMI clears the sample data.																				
	ON→OFF	Only when the specified register changes from ON to OFF, HMI clears the sample data.																				

	OFF←→ON	Only when the specified register changes its status, HMI clears the sample data.
	OFF→ON(reset)	Only when the specified register changes from OFF to ON, HMI clears the sample data. and then reset the specified register automatically.
	ON→OFF(Reset)	Only when the specified register changes from ON to OFF, HMI clears the sample data., and then reset the specified register automatically.
Pause Sample	Use a specified bit register to pause the sampling, ON means HMI stops sampling and OFF means HMI starts sampling. Note: In Sample Once mode, this register will be set ON automatically when the sampling is finished, user can set this register OFF to trigger the sampling again.	

4.15.8 Schedule List

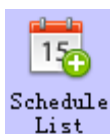

Schedule List is used to configure the operation which will be executed in specific time.

- **【Schedule List】** Interface

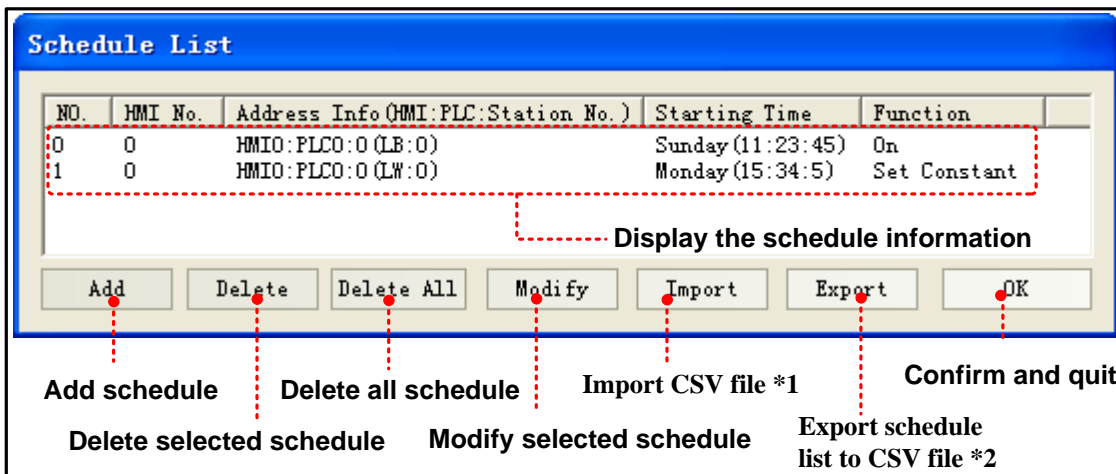

- ※ 1.Import the CSV file which include schedule list format into **【Schedule List】** in the current project.
- 2.Export all the schedule information in current project to specific directory and saved as CSV file.This file can be open by Microsoft EXCEL.

- **【Schedule List】** Setting

Click **【Add】** in **【Schedule List】** to open the setting window of **【Schedule List】** ,its attributes are shown as follows.

Basic Info.		Descriptions
Execute HMI List	Select	Select the HMI which will execute the schedule.
Basic Pro.	Select	Execute when power on
	Select	If HMI power on after the setting time of schedule, then it will execute the “Begin

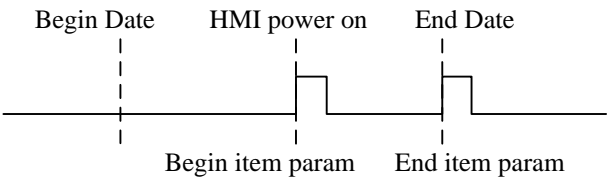
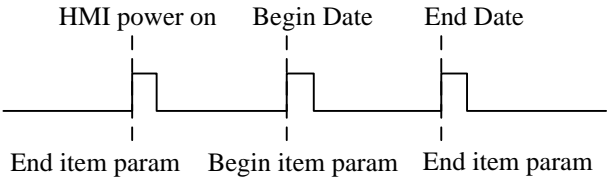
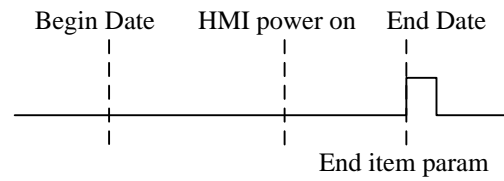
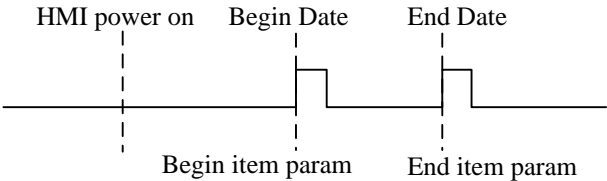
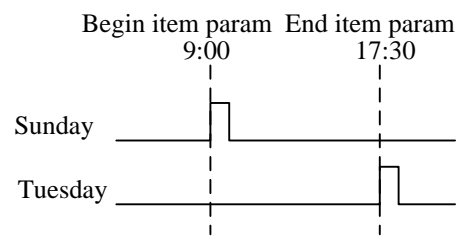
		<p>item param” automatically.</p>  <p>Begin Date HMI power on End Date</p> <p>Begin item param End item param</p> <hr/> <p>If HMI power on before setting time of schedule and select “End item param”,then it will execute the “End item param” automatically.</p>  <p>HMI power on Begin Date End Date</p> <p>End item param Begin item param End item param</p>
Unselect		<p>If HMI power on after setting time of schedule and select “End item param”, then it won’t execute “Begin item param” automatically,but it will execute the end item param automatically.If “End item param” is not selected,then no item will be executed.</p>  <p>Begin Date HMI power on End Date</p> <p>End item param</p> <hr/> <p>If HMI power on before setting time of schedule and not select “End item param”,then it will execute</p>  <p>HMI power on Begin Date End Date</p> <p>Begin item param End item param</p>
<p>Trig Beep.It is used to set the buzzer when start executing preset operation.The range of buzzer is 1~65535s.</p>		
Date and Time	UseSingleDate	<p>When selecting this option,then the begin date and end date can be different,but there can only select one begin date and one end date.</p> <p>For example, begin date is 9:00:00 Sunday,end date is 17:30:00 Tuesday.</p>  <p>Begin item param End item param</p> <p>9:00 17:30</p> <p>Sunday</p> <p>Tuesday</p>

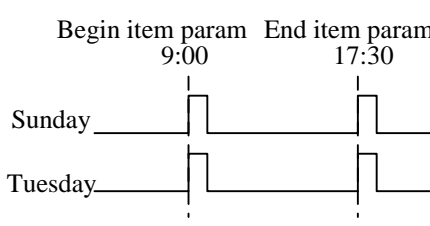
		<p>When unselecting this option, then the schedule is executed within one day(means from the begin date to end date is within 24 hours) ,but it can set multiple begin date and end date.</p> <p style="text-align: center;">Begin item param End item param 9:00 17:30</p>  <p>Note:If the time of end date is earlier than the time of begin date,then the end item param will be executed in next day.</p>																		
Begin Date		Set time and day for begin item param.Format is HH:MM:SS (Hour:Minute:Second).Range:hour (0~23) , minute (0~59) , second (0~59)																		
End Date		When selecting [Use end date],the time of end date can be set. When selecting[UseSingleDate],the day of end date can be set.																		
Variable Date Addr.		<p>It is used to set schedule time and date by local or PLC address.</p> <p>If unselecting [Use end date] , it will occupy 4 words,these addresses are only used for begin date.</p> <p>The variable date addr.=Week. Bit0:Sunday(0:Invalid, 1:Valid).....Bit6:Saturday (0:Invalid, 1:Valid).The format is as following figure.</p> <table border="1" style="margin-left: auto; margin-right: auto;"> <tr> <td style="text-align: center;">15</td> <td style="text-align: center;">7</td> <td style="text-align: center;">6</td> <td style="text-align: center;">5</td> <td style="text-align: center;">4</td> <td style="text-align: center;">3</td> <td style="text-align: center;">2</td> <td style="text-align: center;">1</td> <td style="text-align: center;">0</td> </tr> <tr> <td style="text-align: center;">Reserved (0)</td> <td style="text-align: center;">Saturday</td> <td style="text-align: center;">Friday</td> <td style="text-align: center;">Thursday</td> <td style="text-align: center;">Wednesday</td> <td style="text-align: center;">Tuesday</td> <td style="text-align: center;">Monday</td> <td style="text-align: center;">Sunday</td> <td></td> </tr> </table> <p>The variable date addr.+1=Hour The variable date addr.+2=Minute The variable date addr.+3=Second</p> <p>Exammple 1:The variable date addr. is LW0,then Week=LW0,Hour=LW1, Mintue=LW2,Second=LW3.</p> <p>If selecting [Use end date],it will occupy 8 words,then these addresses are used for begin date and end date.</p> <p>Example 2:if the variable date addr. is LW0,then the begin date is:Week=LW0, Hour=LW1,Minute=LW2,Second=LW3.End date is:Week=LW4,Hour=LW5, Minute=LW6,Second=LW7.</p>	15	7	6	5	4	3	2	1	0	Reserved (0)	Saturday	Friday	Thursday	Wednesday	Tuesday	Monday	Sunday	
15	7	6	5	4	3	2	1	0												
Reserved (0)	Saturday	Friday	Thursday	Wednesday	Tuesday	Monday	Sunday													

Descriptions

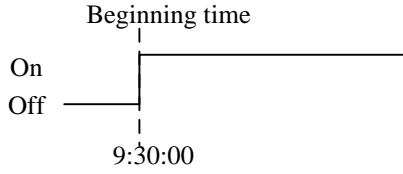
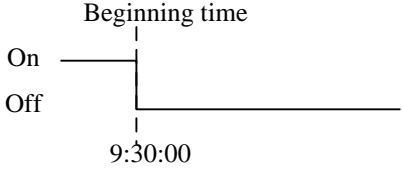
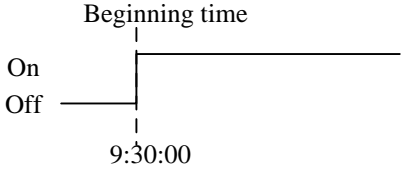
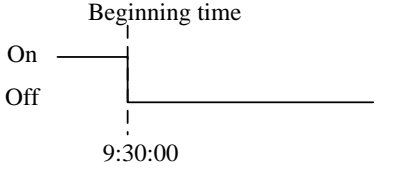
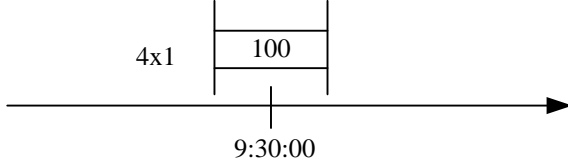
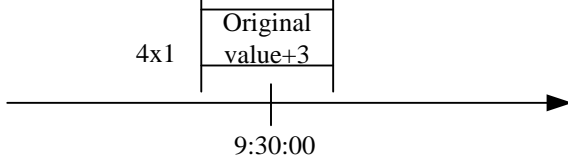
	Execute Type	Descriptions as follows.	
Control Info.	Bit Set	<p>On: it will set the specific bit address as on at the beginning time.</p> <p>For example, beginning time is 9:30:00.</p> 	
		<p>Off: it will set the specific bit address as off at the beginning time.</p> <p>For example: beginning time is 9:30:00</p> 	
		<p>Toggle: it will switch the status of the specific bit address at beginning time. If the original status of the bit address is off, then it will switch to on. Or it will switch to off.</p> <p>For example, beginning time is 9:30:00</p>	
			
	Word Set	<p>Set Constant: it will write a constant to specific register at the beginning time.</p> <p>For example: beginning time is 9:30:00, constant value is 100 and specific register is 4x1.</p> 	
		<p>Add Value: it will use the original value of specific register to add an addend at the beginning time, and its final value will not exceed the upper limit.</p> <p>For example: beginning time is 9:30:00, addend is 3, upper limit is 80 and specific register is 4x1.</p> 	

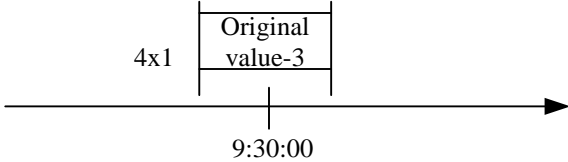
	<p>Sub Value: it will use the original value of specific register to subtract a subtrahend at the beginning time, and its final value will not exceed the lower limit.</p> <p>For example: beginning time is 9:30:00, subtrahend is 3, lower limit is 9 and specific register is 4x1.</p> 
Data type	It is used to select the data type of setting value. It supports 16-bit signed\16-bit unsigned, 32-bit signed\32-bit unsigned, float, double.
Write Address	Set the address which is used for execution.
Variable Param Address	Use variables to change the set value (for set constant), Addend, upper (for add), subtrahend and lower (for sub)



1. If the write addresses are the same in schedule list, it is forbidden to set the same time and date to them.
2. Every time in schedule list only executes once. When it reaches execution time, the specific address will be written a value once.

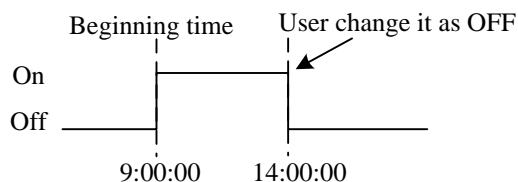

3. Because it needs to read the data of [Word Set] and [Control Setting], the execution may be delayed according to the data communication.
4. When selecting [Variable Date Address], the system will read the address cyclically, the cycle time depends on the busyness of the system.
5. When the value of the variable date address exceeds the range of standard time, then the setting schedule will be wrong.

4.16 Auxiliary Component



4.16.1 Scale



Scale Component is used to set equal scale label for some components, like Bar Picture, Meter and so on. So components that have a scale themselves, they also can use the Scale component.

Scale

Description of Scale component

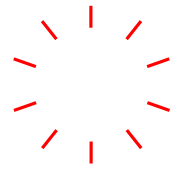
	Horizontal	Vertical	Arc	Circularity
Style				
Equal Division	Set the equal division number			
Line Length	Set the scale length of Arc and Circularity style			
Start/End Angle	Set the start and end angle of Acr style			
Line Color	Set the line color			

4.16.2 Timer

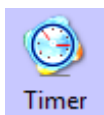

When the setting time is up, Timer will execute corresponding functions, like macro, setting parameters, data transmission and so on.

Timer

Description of Timer Attributes.

Trigger Mode	All time	Timer function will be executed as soon as the timer is initialized, and stopped automatically after the Repeat Count. Then the timer will not be triggered till the next initialization. If the Repeat Count is 0, that means the function is executed all the time.
	Initial frame	Timer function will be executed as soon as the frame is initialized, and stopped automatically after the Repeat Count. Then the timer will not be triggered till the next initialization. It is the almost the same the “All time” Trigger Mode.
	Close frame	Timer function will be executed when the frame is close.
	By re-address	The function will be triggered according to the Trigger Address. When the Repeat Count is 0, it means that the function will be executed till the trigger condition is canceled. When the repeat Count is N, it means that the function will be executed N times if address is triggered, then it will stop automatically.
Execution Cycle	The execution cycle of timer, the unit is hundred milliseconds. The timer executes the Timer Function one time in every execution cycle.	
Response Mode	Immediate	Timer executes the function immediately when the condition is triggered.

	Delay	Timer executes the function in the next execution cycle when the condition is triggered. That is to say, there will be one circle delay.
Trigger State	In the By reg-address mode, the Trigger State is On or Off.	
Repeat Count	The execution number of timer function. If the Repeat Count is 0, it means the function will be executed all the time.	
Trigger Address	In the By reg-address mode, set the register address for trigger register.	

Timer Function

Execute Macro

Execute the specified macro program. That is to say, when the timing time is up, the macro will be executed

Data Transmission

Transmit the data in batch. When the timing time is up, timer transmits corresponding length data from Source Address to Destination Address

Source Address	Set the source address of data
Destination Address	Set the destination address of transmitting data
Data Type	Set the type of transmitting data, bit or word
Data Length	Set the number of transmitting data

State Setting

Change the state or value of specified register. When the timing time is up, timer changes the state of corresponding bit register or write value to the word register.

Bit	Set Value	When the "Execution Cycle" time is up, set the bit register to 0 or 1.
	Periodical Toggle	When the "Execution Cycle" time is up, toggle the bit register between 0 and 1.
Word	Periodical JOG++(circle)	<p>Add an Asc value (K) to the data (V) of specified register automatically in every execution circle. When the data reaches to the Upper limit, it will start from 0 again.</p> <pre> graph LR A[0] -- T --> B[V+K] B --> C{Upper limit} C -- NO --> B C -- YES --> A </pre>
	Periodical JOG--(one way)	Subtract a Desc value (K) from the data (V) of specified register automatically in every execution circle. When the data reaches to the Lower limit, the data will stop at the lower limit.

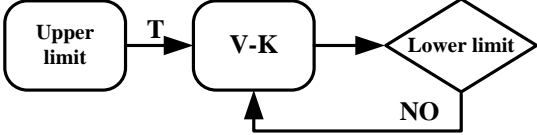
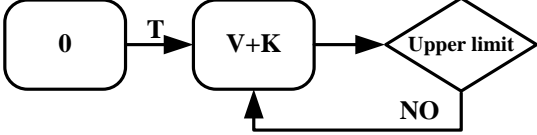
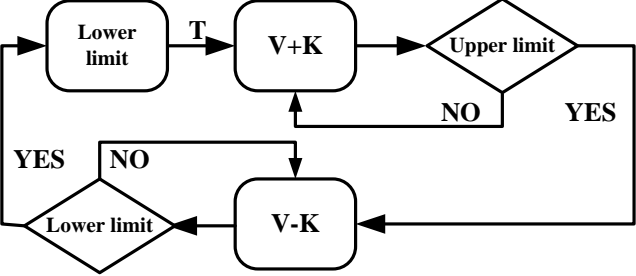
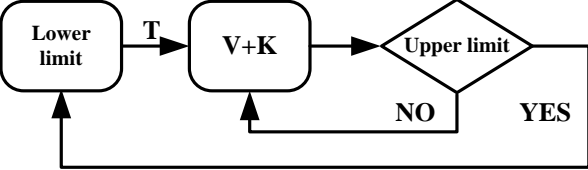
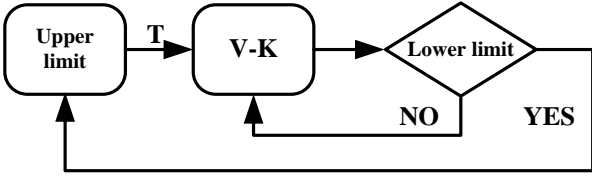
	
<p>Periodical JOG++(one way)</p>	<p>Add an Asc value (K) to the data (V) of specified register automatically in every execution circle. When the data reaches to the Upper limit, it will stop at the Upper limit.</p> 
<p>Periodical Bounce(turnover upon limit)</p>	<p>Add a Step value (K) to the data (V) of specified register automatically in every execution circle. When the data reaches to the Upper limit, subtract a Step value (K) in every execution circle till 0, then start add Step a value (K) to the data again, repeat the above process circularly.</p> 
<p>Step Up(circle)</p>	<p>Add a Step value (K) to the data (V) of specified register automatically in every execution circle, when the data reaches to the Upper limit, it will be reset to the Lower limit, then start to add step value again from the Lower limit.</p> 
<p>Step Down(circle)</p>	<p>Subtract a Desc value (K) from the data (V) of specified register automatically in every execution circle, when the data reaches the Lower limit, it will be reset to the Upper limit, then start to subtract step value again from the Upper limit.</p> 
<p>Set Constant</p>	<p>When the timing time is up, the preset constant will be written to the specified register.</p>

4.16.3 Scroll Bar



Scroll Bar is used to change the value of HMI or PLC register by moving the slider, and the scaling relation between actual value and Min/Max is displayed by the position of slider.

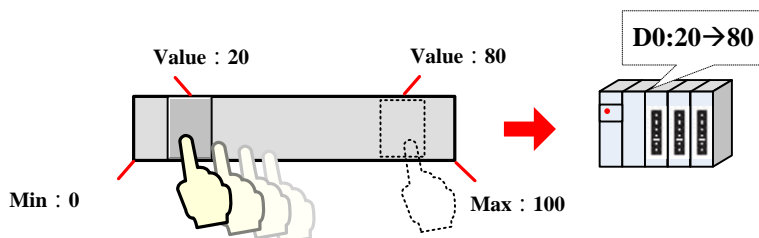

Scroll Bar

Description of Scroll Bar Attributes

Word Length of Index Number	Word and Double Word are optional.
Direction	Set the direction of scroll bar, there are four directions; they are From Left To Right, From Right To Left, From Up to Down and From Down to UP.
Background Image	Set the background image of scroll bar, there are three options; they are Not Used, Vector Graphics and Bitmap.
Import Image	Import the background image from the system image library.
Button Image	Set the button image of scroll bar, there are three options; they are Not Used, Vector Graphics and Bitmap.
Import Image	Import the button image from the system image library.

Scroll Bar Extended Attributes

Description of Scroll Bar Extended Attributes

Slider Width	Set the width of slider, ranges from 1 to 99. Uncheck means that the slider uses the default width, which is 10 pixels.		
Max/Min Value Setting	Set the start value and max value of scroll bar.		
Variable Setting	<table border="1"> <tr> <td>Max/Min</td> <td>Value</td> </tr> </table> Set the variable for the Min and Max for the scroll bar, and set the register address, the specified address is the Min, and the specified address+1 is the Max.	Max/Min	Value
Max/Min	Value		
Set Scroll Mode	Ranging from 1 to 100, each time user clicks scroll bar , it adds or subs the setting value.		



The Scroll Bar will not takes 3 words after V1.4.0.0, because the Min and Max can be set as constant, if the Min and Max use variable, user can set the register separately.

4.16.4 Date/Time

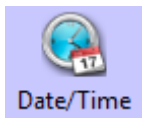

Date/Time component is used to display HMI system date and time in specified format.

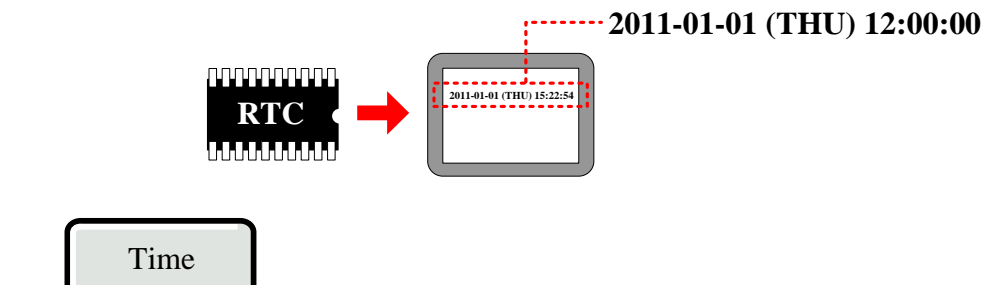

Description of Time attributes		
Display Date	Set the component to display date or not	
	Date format	Four formats are optional. DD means day, MM means month, YY means year.
	Date Separator	Three formats are optional, for example, 2011.01.01.
	Year 4-digital Display	Checked means Timer displays year in 4 numbers, for example 2011; unchecked means Timer displays year in 2 numbers, for example 11.
	Zero suppress for Year and Day	Checked means there is not a 0 before year and month take June for example, when this option is checked, Timer displays 6, if unchecked, and Timer displays 06.
Display Week	Set the component to display week or not, the week is displayed in abbr.	
Display Time	Set the component to display the time or not.	
	Time	Two formats are optional: HH means hour, MM means minutes, SS means second.
	12-hour System (AM/PM)	Checked means Time is displayed in 12-hour system, take the three o'clock in the afternoon for example, if this option is checked, it displays 3:00 PM , if unchecked , it displays 15:00.



The Date/Time component can read the RTC time in the HMI, but cannot change it. If user need to change the date or time, they can change it in HMI SETUP screen or via system special registers(LW10000~LW10006)

[For details, refer to \[Advanced Part 2.7 RTC Set\]](#)

4.16.5 Note Pad

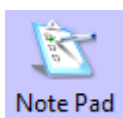

Note Pad is the message board function; it is used together with the Message Board function in the Function Key.

4.16.6 File List

File List is used to display the file information in the external memory device. It is divided into three area: the left part displays the file folder information of current catalog. Upper right part displays the file information of current catalog; the Lower right part displays the chosen project file (.pkg file) or recipe file (.rcp file) of current catalog.

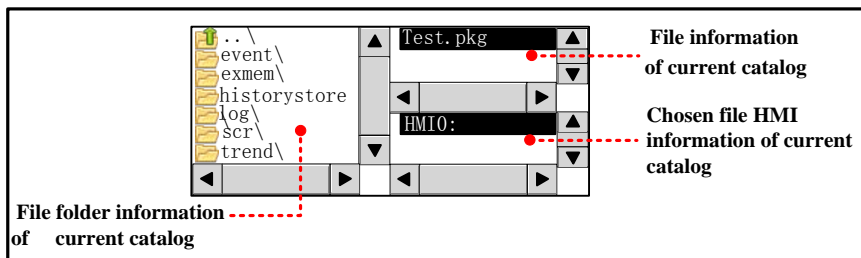
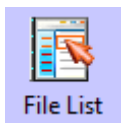

File list component is a special component; it is usually used together with the Import/Export function of Function Key. System also provides [Frame5: File List Window] as file list when user import/export project file or recipe file in the SETUP screen. And the File Browser Window can be changed in the HMI Attributes.

Initial Window	0:Frame0	File Browser Window	5:File List Window
Public Window	1:Common Window	Operation Confirmation Window	7:Confirm Action Window
Fast Selection Window	2:Fast Selection	Login Window	9:Login Window

4.16.7 Trigger Touch



Trigger Touch is used to trigger multiple components without touching them, when the specified address satisfies the setting Trigger Type condition, all the components in the Trigger Touch area will be triggered.

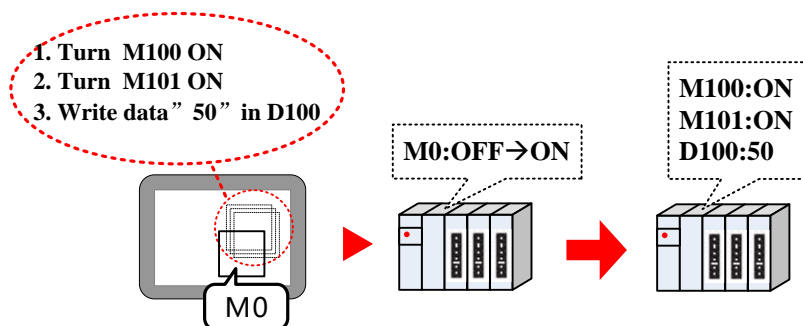

Take the following component for example:

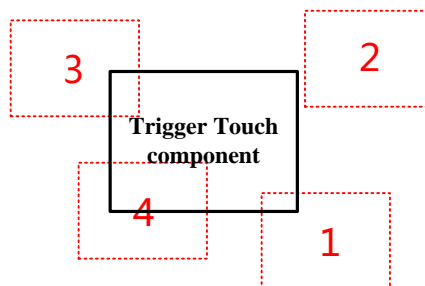

The components (1, 3 and 4) are in the Trigger Touch area.

The component 2 is not in the Trigger Touch area.

When the specified address satisfies the setting Trigger Type condition, the 1, 3 and 4 will be triggered, but 2 will not be triggered, because it is out of the Trigger Touch area.



Detail Description of Trigger Touch	
Trigger Touch	Description
OFF→ON	When the specified register changes from OFF to ON, the components in the Trigger Touch area will be triggered.
ON→OFF	When the specified register changes from ON to OFF, the components in the Trigger Touch area will be triggered.
OFF↔ON	When the specified register changes its state, the components in the Trigger Touch area will be triggered.
OFF→ON (reset)	When the specified register changes from OFF to ON, the components in the Trigger Touch area will be triggered. At the same time, reset the specified register to OFF.
ON→OFF (reset)	When the specified register changes from ON to OFF, the components in the Trigger Touch area will be triggered. At the same time, reset the specified register to ON.

5 Better Understanding of Library

In Kinco HMIware, user can load the text, address tag, graphic and sound in the database, when they need to use this information, they can call it from the database directly, this database is called library in Kinco HMIware. This chapter will give you a detail description of how to use library.

5.1 Text Library

We will describe how to use Text Library in this section.

5.1.1 Create a Text Library

(1) Click on the Option (O) menu>>Text Library (T) or the  icon in the tool bar or the Text Library in the Project Database of Graph element window to open the Text Library dialog box.

(2) Click on the Add to pop up the Add Text dialog box.

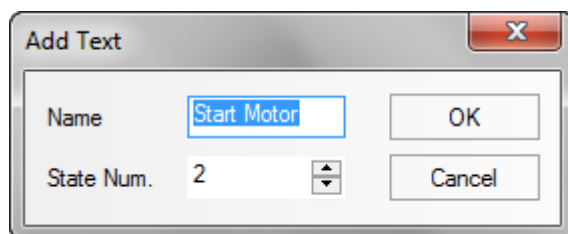

For example, build a text item named “Start Motor” , the State Num is 2, each text supports 256 states at most. Click on the Ok to finish building the text, and click on the Cancel to give up this text.



The Name of text cannot be modified after it is built

After setting the Name and State Num, click on the OK to the next step.

(3) The text named “Start Motor” has been added to the Text Library, click on the  icon before “Start Motor” to view the states of this text, there are two states: 0 and 1. Click on the blank area under the each language to input text content. In this example , we input “启动” in the language1 of state 0, and “停止” in the language1 of state 1; Input “Start” in the language2 of state 0, and “Stop” in the language2 of state 1.

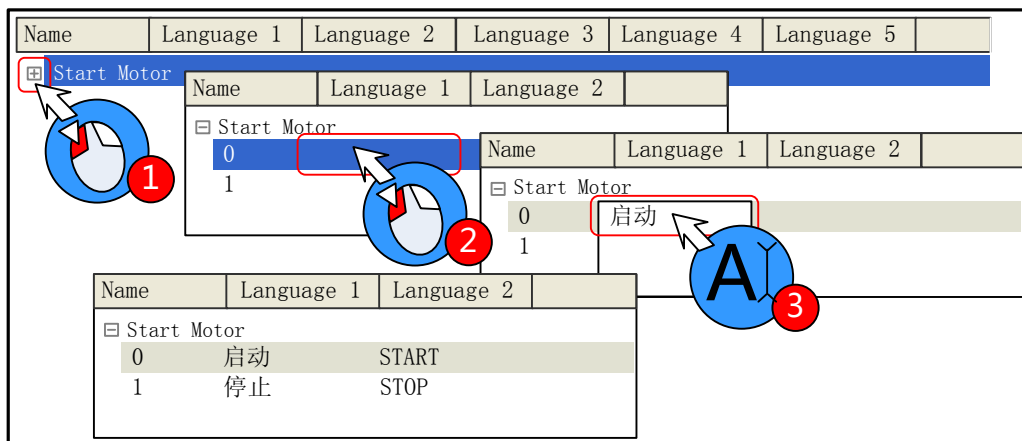

Besides, user can add/delete/modify the text state by right click option, take the following picture for

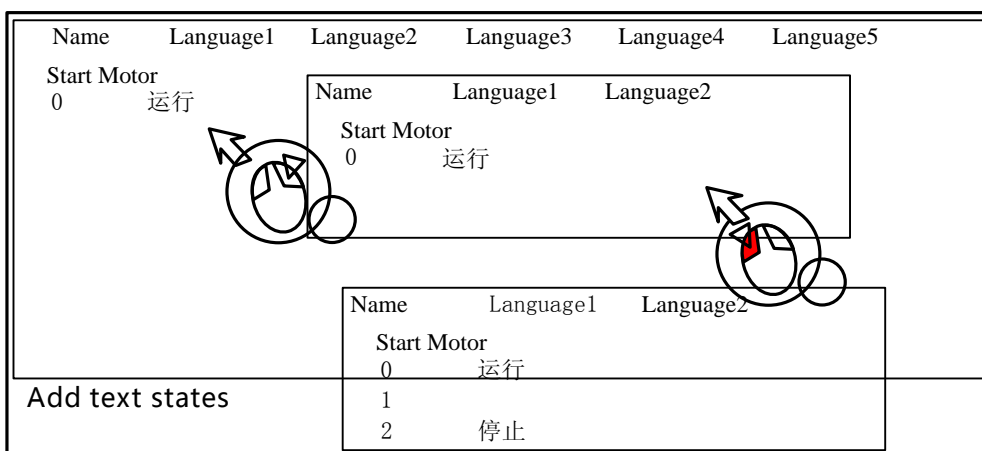

example:

(4) Click on the OK to close the Text Library dialog box after editing. Check the "Use Textlib" in Tag option of a component and then select a already built text in list.

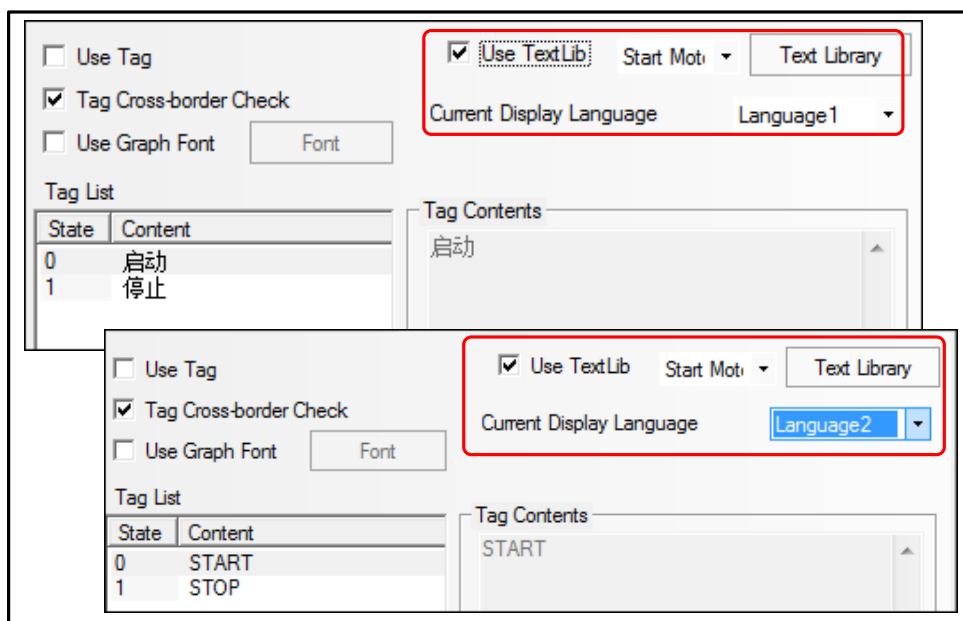

5.1.2 Export/Import Text Library

The built text library can be exported in a csv file, and the csv file also can be import into the Text Library.



Import/export the whole text library, but cannot import/export a single text item

(1) Export text library

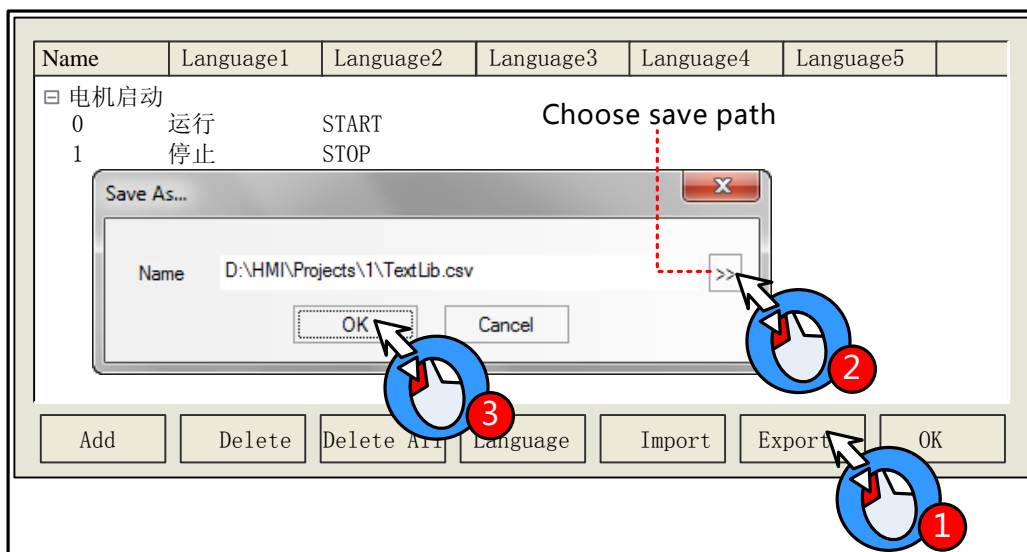

The exported csv file can be edit by Microsoft Excel.

(2) Import text library

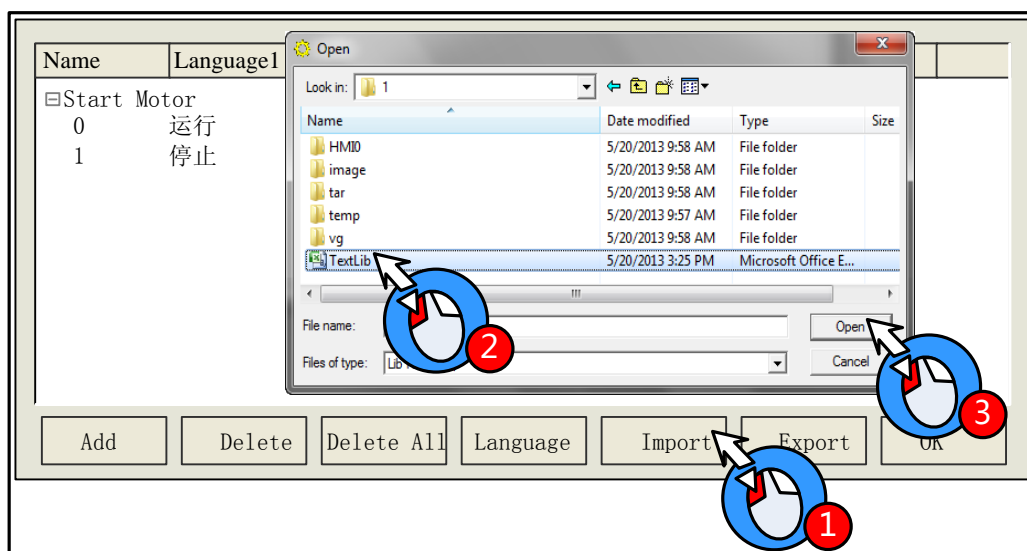

5.1.3 Set the Language of Text Library

Click on the Language Setting in the HMI Extended Attributes option of HMI Attributes or the Language in the Text Library dialog box to open the Language Setting dialog box, and then set the global font attributes of each language.



1. The font attributes in Language Setting is global, and the font attributes in the tag option is only for the tag content of current component.
2. If the font attributes in Language Setting change, it will not affect the font attributes of the tag which has already used the text in text library, if user want this font attributes to be the same as the Language Setting, they can cancel the "Use Textlib" in the tag and then recheck it, so the font attributes is refreshed.

5.1.4 Text Library Application

- Edit the Text Library quickly

When there is a lot of text content in text library, user can export the text library in a csv file , then edit it in the Microsoft excel, it is very conveniently to edit in this way.

Firstly, build a text library, and then set the state number and text content.

Name	Language1	Language2	Language3	Language4	Language5
Start Motor					
0					
1					

Export the text library to a csv file in your PC, and then open and edit it by Microsoft Excel, you can edit the text name, state number, text content and add new text item.

	A	B	C	D	E
1	Text Lib	V100			
2	Name:	Start Motor			
3	Status:	2			
4	Language	Language1	Language2	Language3	Language4
5	0	启动	RUN	運転	
6	1	停止	STOP	停止	
7					

Modify text name
 Modify text state
 Modify text content

The Name, Status, Language1~32 are fixed formwork, if they are modified, there will be problem when the csv file is imported to the Text Library.

Save the csv file before close it :

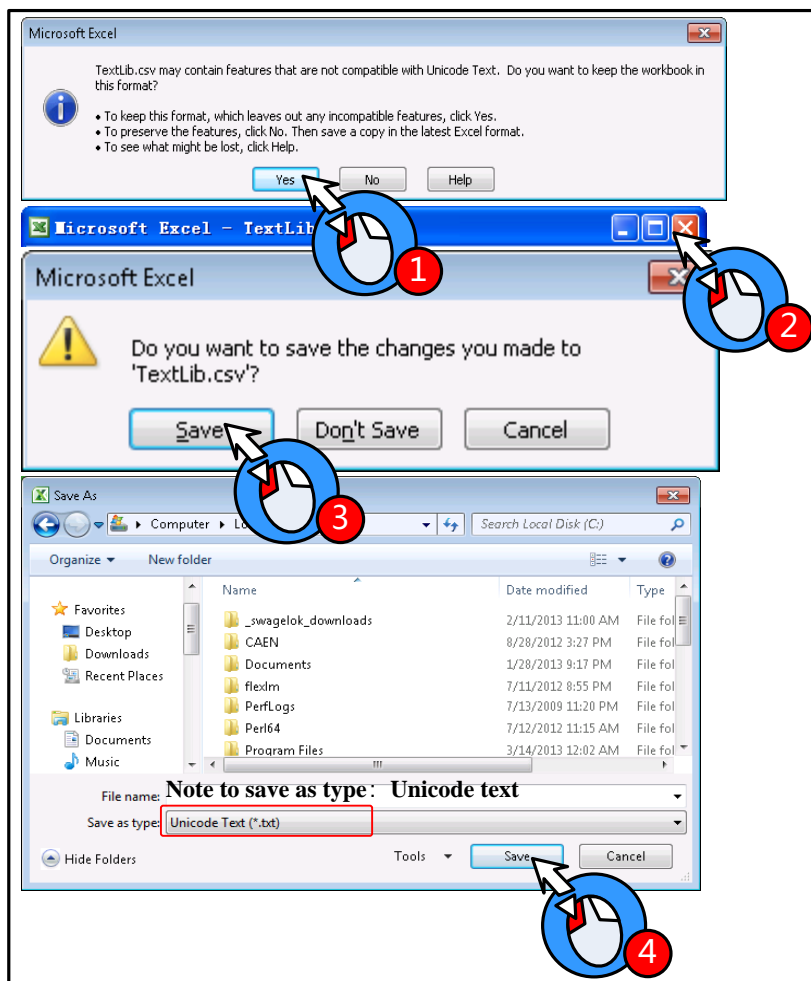

At last, import the text library file (textlib.csv) to the project.



When importing the text library file, if there is a text in the project text library has the same name as the text in the file, there will be a tip to warn that whether you want to cover the same name text or not, the covered text cannot be regained.

- Use Text Library to switch multiple languages

Use the special system register LW9130 to switch the languages in text library

When LW9130=0, HMI displays the text content in Language1; when LW9130=1, HMI displays the text content in Language2...and so on, When LW9130=31, HMI displays the text content in Language32; if the LW9130>31, HMI displays the text content in Language1.



The Number of Language in the HMI Extended Attributes of HMI Attributes will limit the language number in Text Library. The default language number is 8 in Text Library, even if the LW9130>8 , HMI only displays the Language1~Language8. If user wants to use more than 8 languages, he needs to set the Max Lang Num in Language Setting, and the Number of Language must be smaller than Max Lang Num. The

Default Language means the default language that HMI displays, for example, the language2 is English in Text Library, if the Default Language is 2, HMI will display the text content in English till LW9130 changes.

[For details, refer to \[Advanced Part 2.6 Language Switching\]](#)

5.2 Address Tag Library

We will describe how to use Address Tag library in this section

5.2.1 Build a Address tag Library

(1) Click on the Option (O) menu>>Address Tag (A) or the  icon in the tool bar or the Address Tag in the Project Database of Graph element window to open the Text Library dialog box.

(2) Click on the Add to pop Build Address Tag dialog box

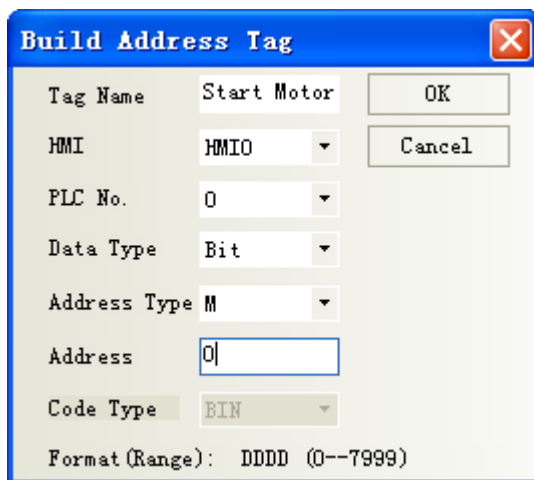

For example, build an address tag named “Start Motor” , the address is M0. Click on the OK to finish building this address tag, and click on Cancel to give up this address tag.

5.2.2 Address Tag Application

After building the address tag in Address Tag Library, check the Use Address Tag, and chose the corresponding address tag name. Take the following picture for example:

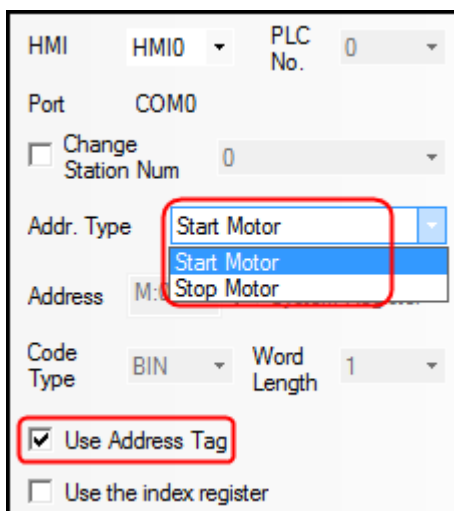



Bit component can only use the bit address tag; and the word component can only use the word address tag.
 The Address Tag library supports being imported and exported; the import/export operation is the same as the Text Library.

5.3 Graphic Library

Kinco HMIware provides user rich vector graphic and bit map. User can draw vector graphics, like, switch, lamp and so on. User also can import external pictures to bit map. We will describe how to use the Graphic Library in this section.

5.3.1 Import Graphics

(1) Import Graphics

There are three methods to open the Import Graphic dialog box

1. Click on the icon
2. Click on the Import Graphics Library in Draw (D) menu.
3. Click on the Import Graphics in the Graphics option of a component attributes.

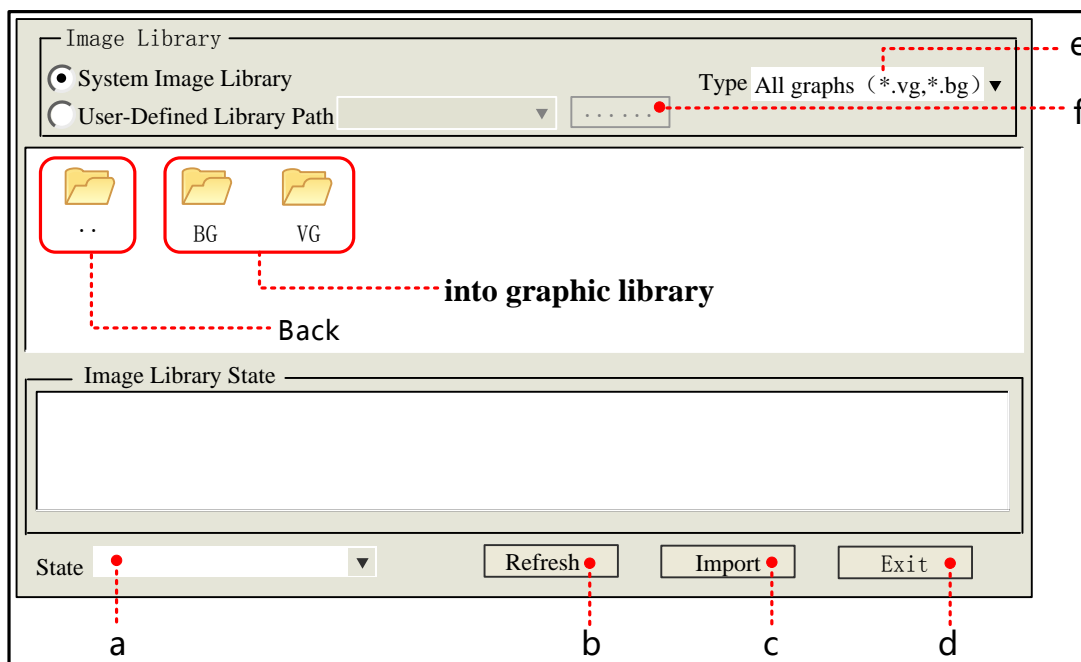

- a. Switch the states of selected graphic.
- b. When all graphic are not displayed in above area, click on Refresh to display them all.
- c. Choose a wanted graphic in above area, click on the Import to load this graphic (vg or bg) to current project.
- d. Close the Import Graphic dialog box
- e. Set the graphic type that needs displaying in following area.
- f. Open the route selection dialog box.

There are two sources for graphic library

System graphic library: The graphic library in software, it is in the vg_bg_lib file folder of Kinco HMIware installation file folder.

There are two parts for graphic display area, the upper half displays all thumbnail in graphic library, the lower half displays all states' preview graphic of selected graphic

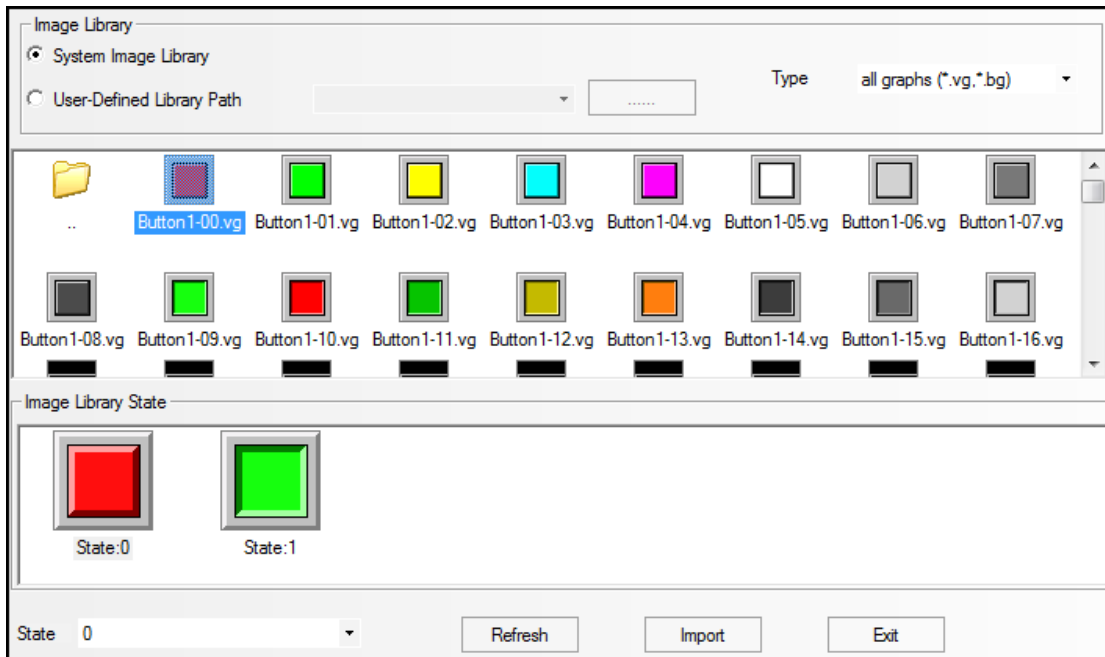

Import graphic from system graphic library, for example, import the button named “Button1-00.vg” from the System Graphic Library>>Vg>> Button, the operation steps are as follows:

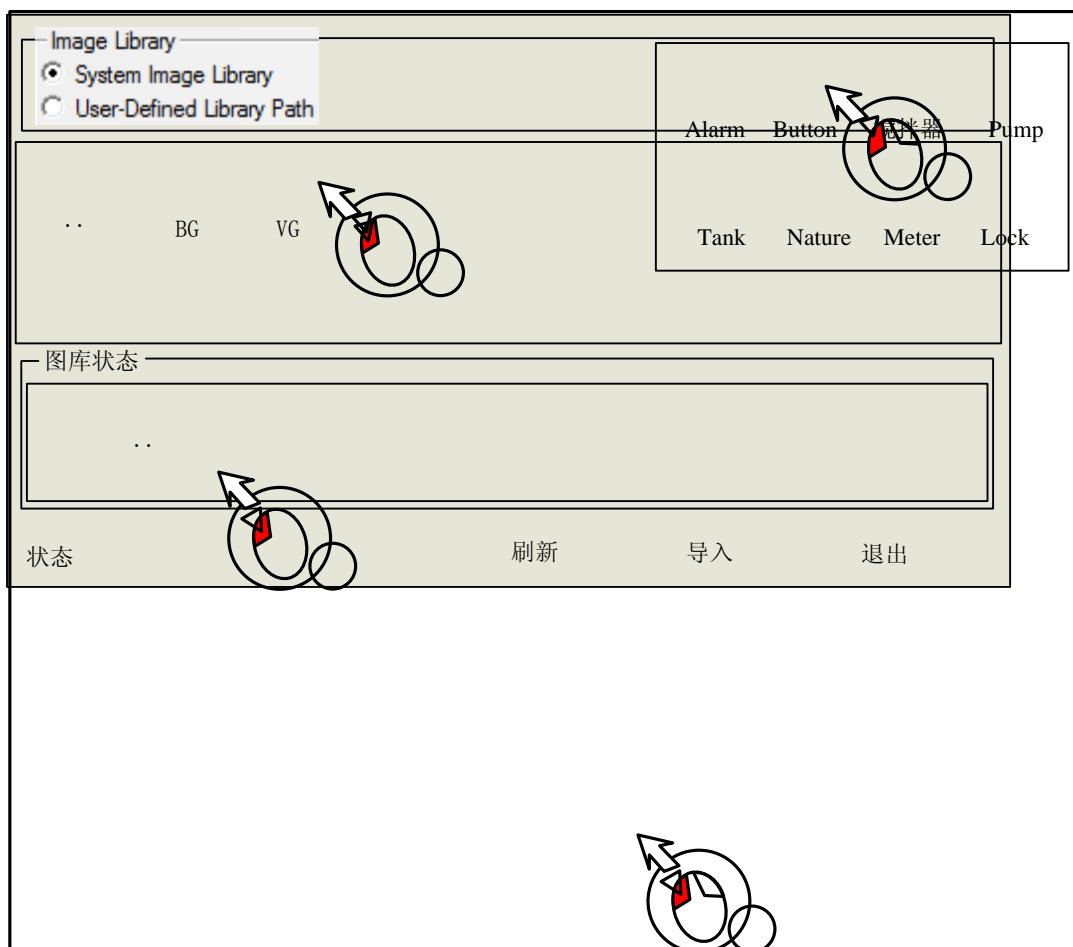



If the imported vector graphic (vg) or bit graphic (bg) has the same name as the graphic in current project graphic library, there will be a Modify Image Name dialog box to input a new name.

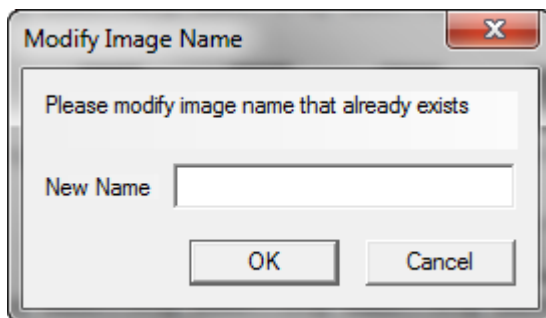

- User-defined Library Path: user can import a vg or bg from a specified route, that is , user can import the graphics from the vg file folder of other project files. For example , import graphic from D:\Program Files\Kinco\Kinco HMIware\project \control system\ vg, the steps are as follows:

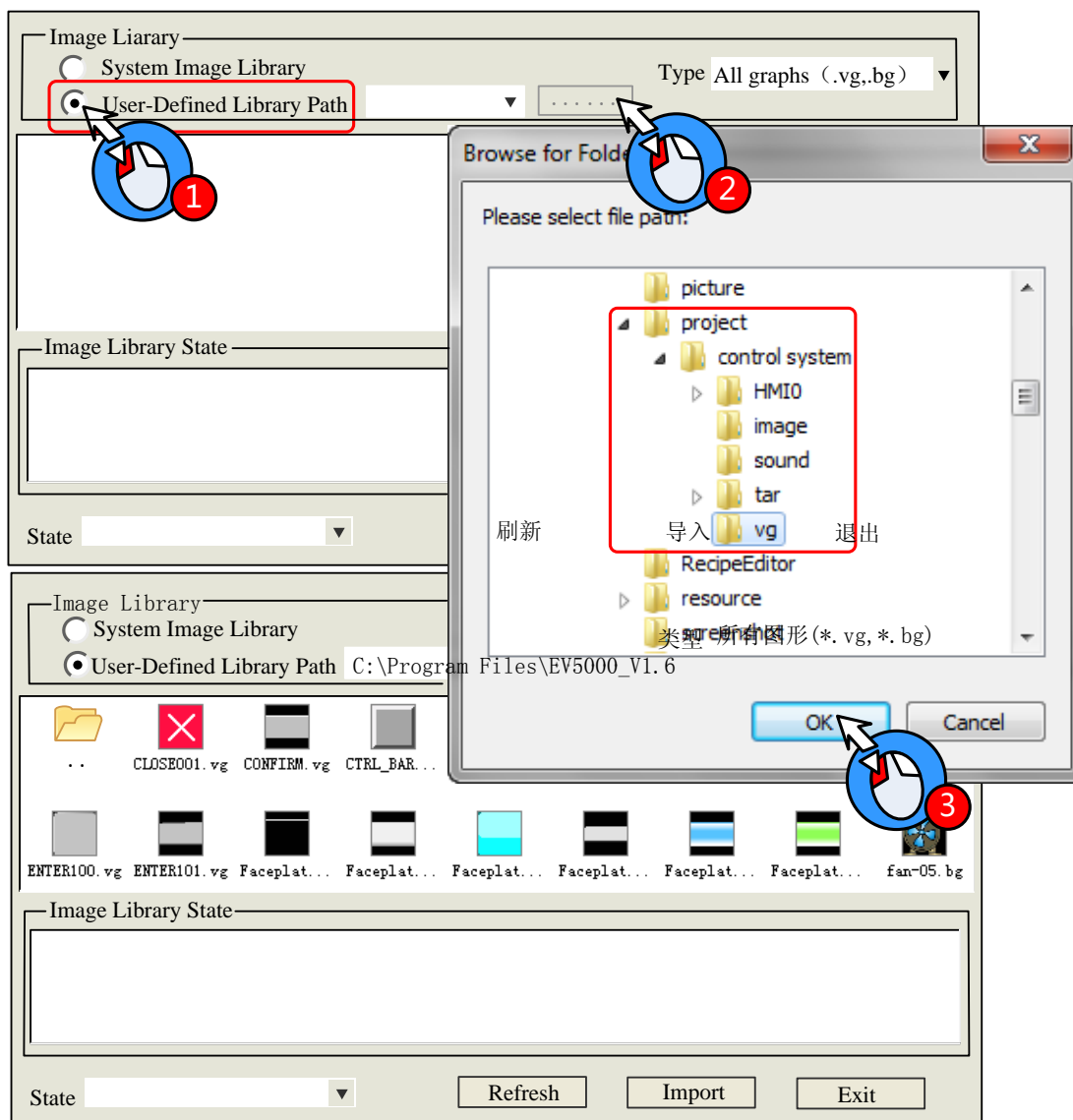



Multiple vg/bg cannot be imported/exported at the same time

2. Export Graphic

The imported vg/bg from system library or the new build vg/bg graphics are stored in the vg file folder of project file folder.

There are two methods to save the graphic in current project to system graphic; they are stored in `vg_bg_lib>>vg/BG >>UserSelPath` file folder of Kinco HMIware installation file folder. So user can use these graphics in the other project.

1. Project File Window>> Vector Graph

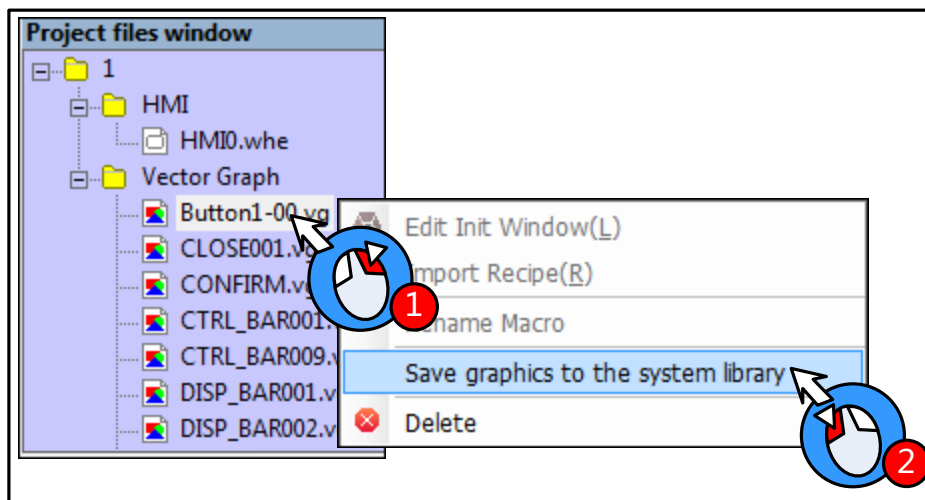

2. Graphic option of component attributes

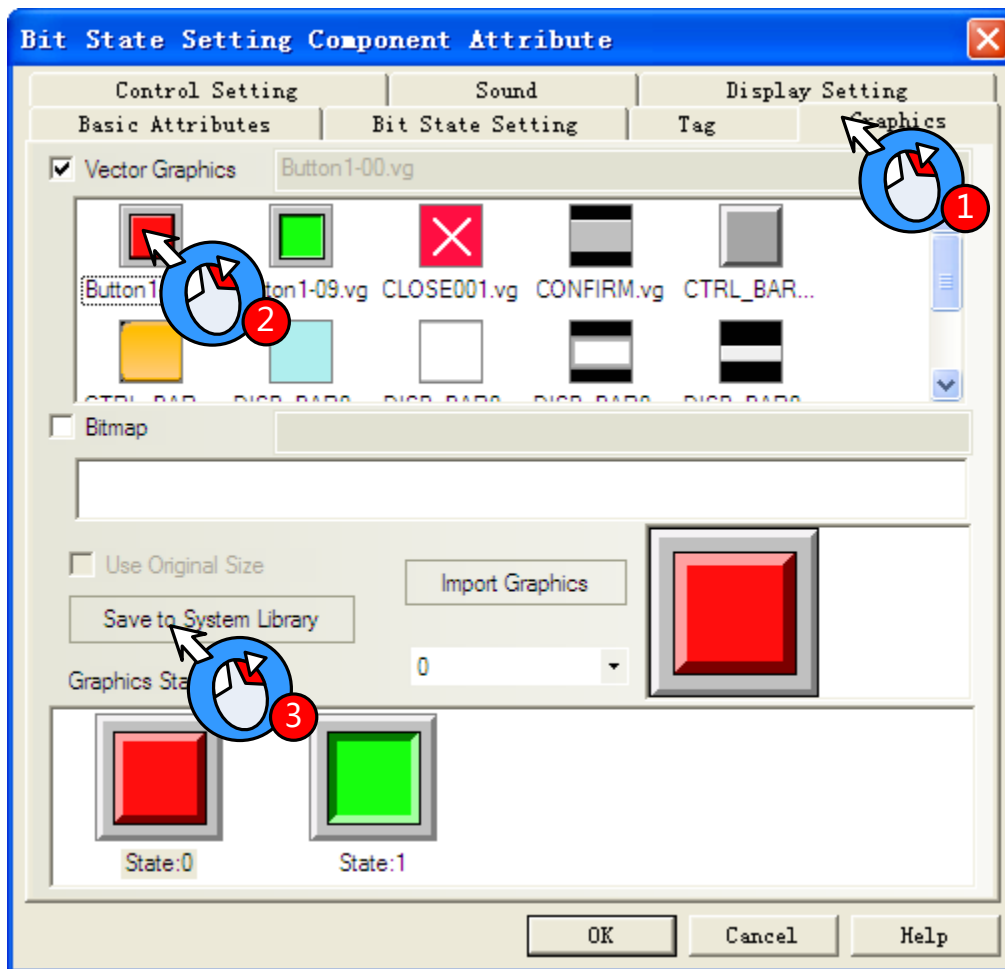

5.3.2 Build New Graphics

If the vg/bg in system graph library cannot satisfy user's application, he can build new vg/bg himself.

(1) Build a new vector graph

The New Graphics button

For example, draw a indicator light name "Lamp" and has two states: Click on the icon  or New Graphics (N) of Draw (D) menu to open the New Graphics dialog box:

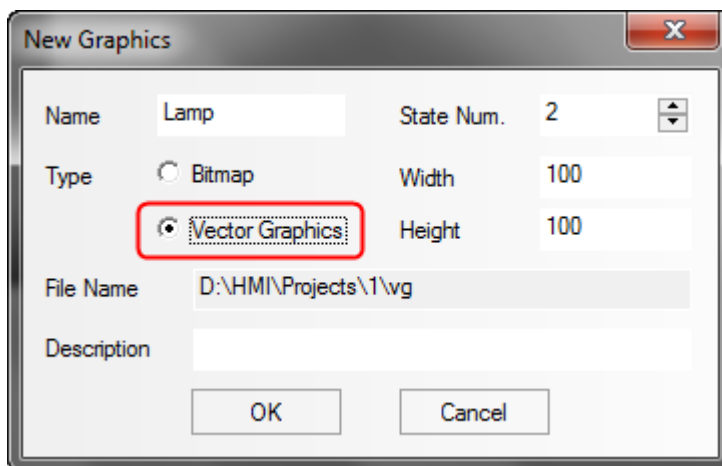

New Graphics dialog box	
Name	The name of new graph
State Num	Set the state number of new graph, it is 256 at most
Type	The type of new graphic: vector graph or bit map
Width/Height	Set the width and height of new graph, the unit is pixel
File Name	The store route of new graph
Description	The note information for new graph



The width and height cannot be modified after being built.

Choose the Vector Graph type, input “Lamp” as its name and set 3 to State Number, use the default width (100) and height (100). Click on OK to enter the graphics edit window:

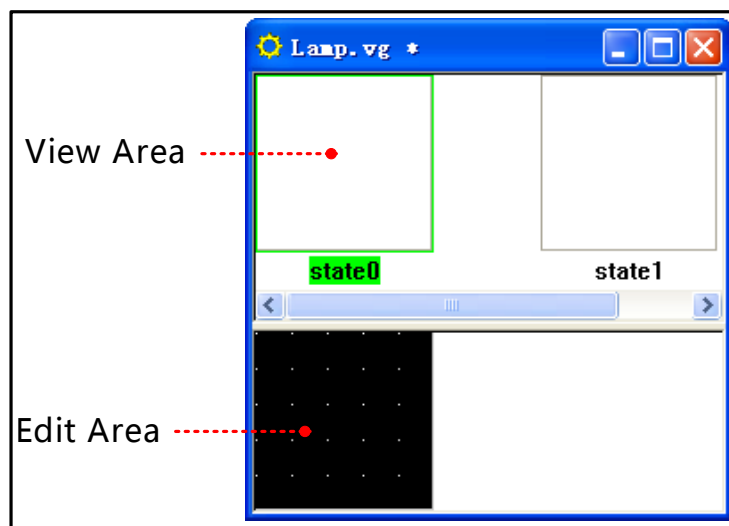

Draw the graphics for State0 and State1; see the drawing steps as follows:

Example	Draw a base for the lamp
---------	--------------------------

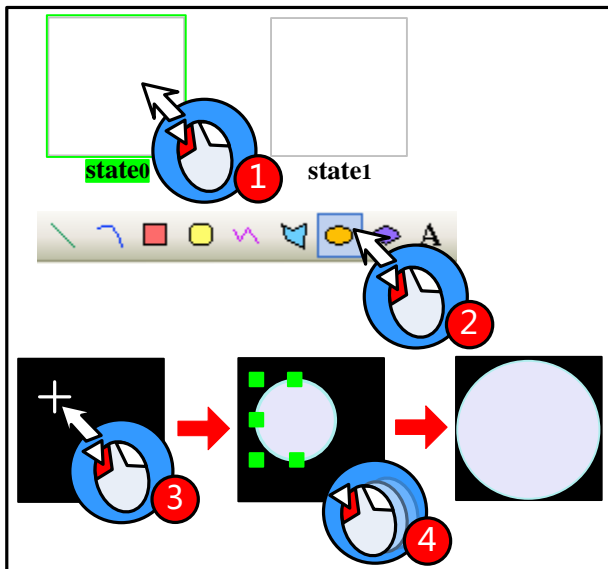

1. Choose State0
2. Choose the Ellipse in the draw tool bar.
3. Move the mouse to edit area, and left click when the + icon appears.
4. Draw a ellipse

[For details about how to draw a ellipse, refer to \[Advanced Part 2.2 Draw\]](#)

Example Set the graph attributes

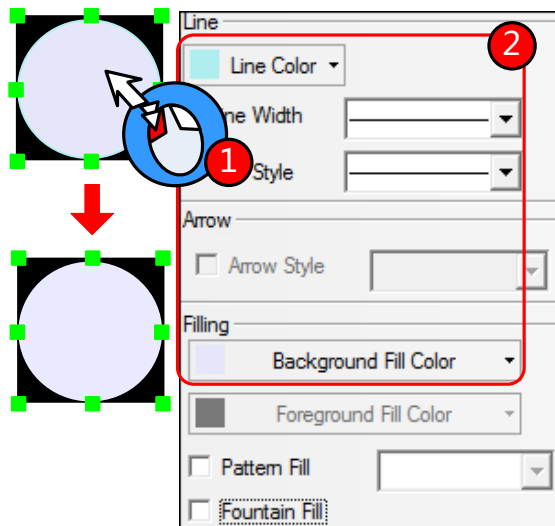

1. Double click the ellipse to open graphic dialog box.
2. Set the ellipse attributes as follows:

Line Color	RGB(230,230,250)
Filling Color	RGB(230,230,250)

Example Draw lamp and flashing effect

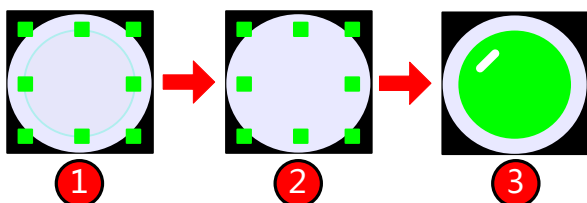

1. Draw a ellipse which is smaller than the base.
 2. Set the ellipse attributes as follows:
- | | |
|---------------|--------------|
| Line Color | RGB(0,255,0) |
| Filling Color | RGB(0,255,0) |
3. Draw a short line on lamp as the flashing effect.

[For details about how to draw a line, refer to \[Advanced Part 2.2 Draw\]](#)

Example Draw graph for State1

1. Select all the graphics of State0 and copy(Ctrl+A and Ctrl+C)
2. Select the State1, paste the graphics to state1(Ctrl+V)
3. Set the lamp attributes of Stae1 as follows:

Line Color	RGB(255,0,0)
Filling Color	RGB(255,0,0)

After drawing the lamp graphics, click on the Save in File menu or icon to save the new graphic, at last click on the icon to close the graph edit window.

The new vector graphics will be saved as vg format file, they are in the vg file folder of current project file folder



User can only use the draw bar to draw pictures on vector, but cannot add some text or external picture to vector graph.

Save to the VG map

User also can draw vector graphics in project edit window and then save them as VG map.

For example, draw a vector graph named “button”, and has two states. The drawing steps are as follows:

Example	Draw graphics for State0				
	<ol style="list-style-type: none"> 1. Draw a polygon in HMI Edit Window 2. Double click the polygon, set its attributes as follows: <table border="1"> <tr> <td>Line Color</td> <td>RGB(0,0,0)</td> </tr> <tr> <td>Filling Color</td> <td>RGB(165,165,165)</td> </tr> </table> 3. Copy (Ctrl +C) and paste (Ctrl +V) the polygon. 4. Rotate the polygon2 horizontally and then vertically. 5. Double click the polygon2 to set its 	Line Color	RGB(0,0,0)	Filling Color	RGB(165,165,165)
Line Color	RGB(0,0,0)				
Filling Color	RGB(165,165,165)				

attributes as follows:

Line Color	RGB(0,0,0)
Filling Color	RGB(255,255,255)

6. Draw a rectangle, and double click to set its attributes as follows:

Line Color	RGB(0,0,0)
Filling Color	RGB(0,255,0)

Now finish drawing the graphics of State0.

[For details about how to draw a rectangle, refer to \[Advanced Part 2.2 Draw\]](#)

Example Save the graphics of State0

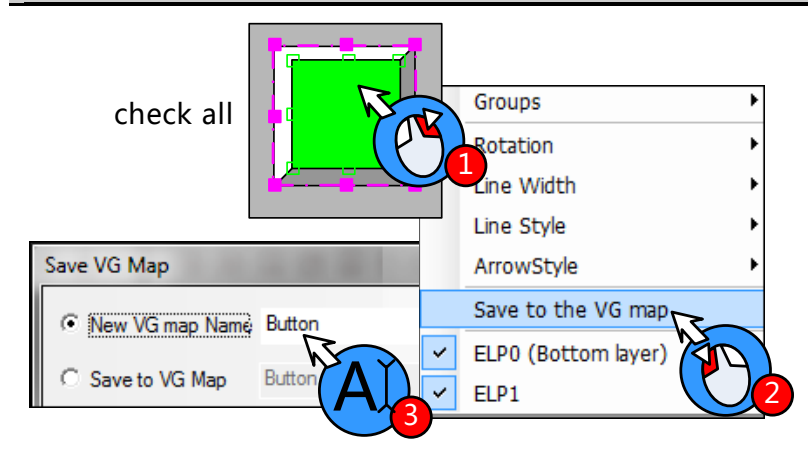

1. Select all the graphics of State0, then right click.
2. Choose the Save to the VG map in the right click option
3. Set a name for this vector graph in the popped up dialog box, and then click on OK to save.

Example Draw graphics for State1

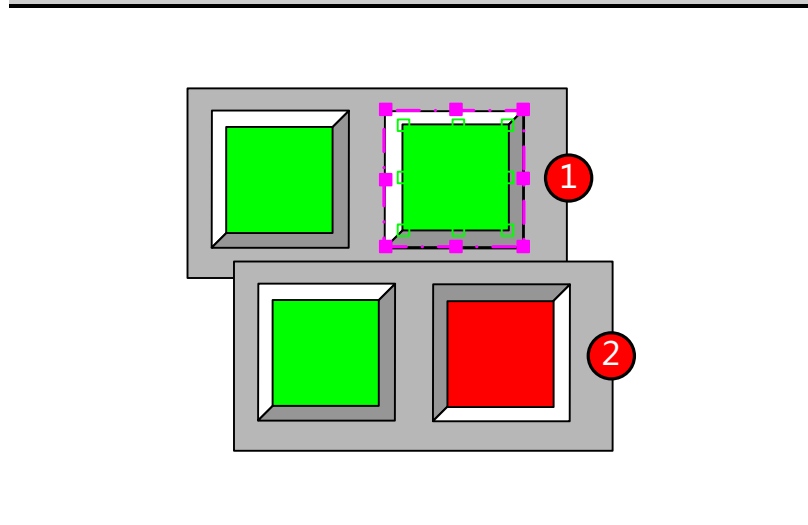

1. Select all the graphics of State0, and then copy (Ctrl +C) and paste (Ctrl +V)
 2. After pasting, exchange the two polygons, and set the rectangle's attributes as follow:
- | | |
|--------------|--------------|
| Line Color | RGB(0,0,0) |
| Filing Color | RGB(255,0,0) |
- Now finish drawing the graphics of State1.

Example Save the graphics of State1

1. Select all the graphics of State1, then right click.
2. Choose the “Save as VG map” in right click options.
3. Choose the “Save to VG map” in the popped up dialog box.
4. Choose the “New State” in the Graphics States.



The New States in Save VG map dialog box means add a new state to the vg, Update Current State means replace a specified state.

User can view the saved vg in Vector Graph of Project file window.

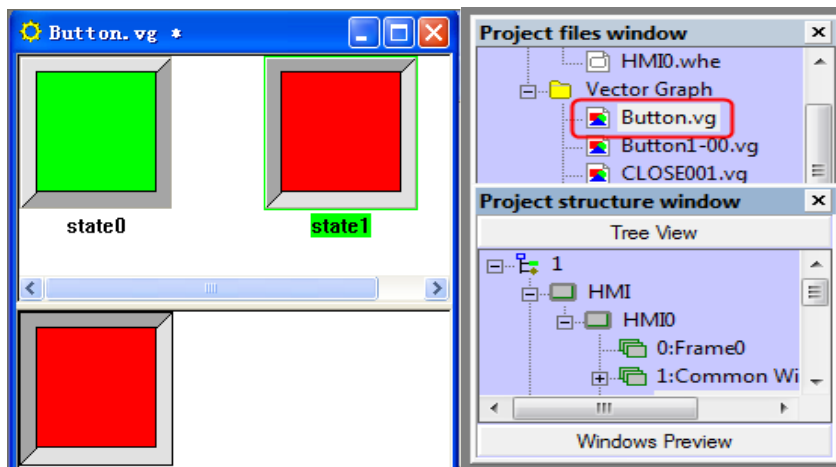

(2) Build a new bit map

For example, build a new bit graph named “Button” , and it has two states. Click on the New Graphics (N) of Draw (D) menu or icon  to open the New Graphic dialog box.

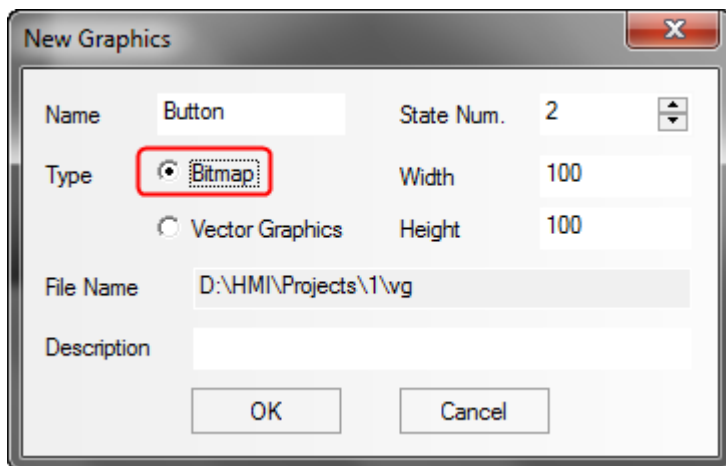

Choose the Bit Map type and input “Button” as its name, set the State Num to 2, and then click on the OK to enter the graph edit window

Import a picture for State0:

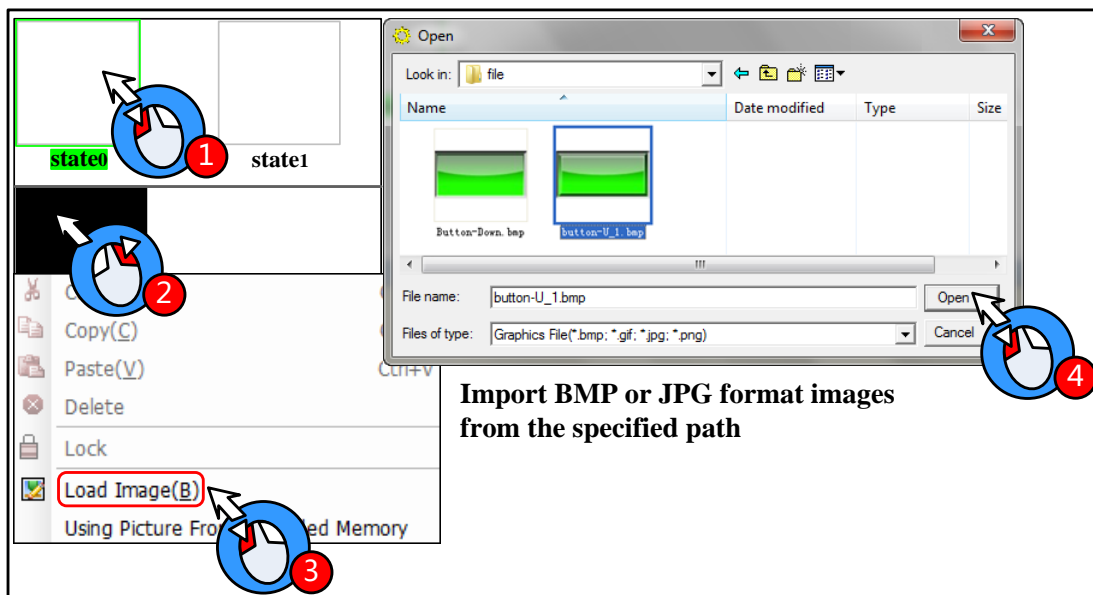

Import a picture for State1

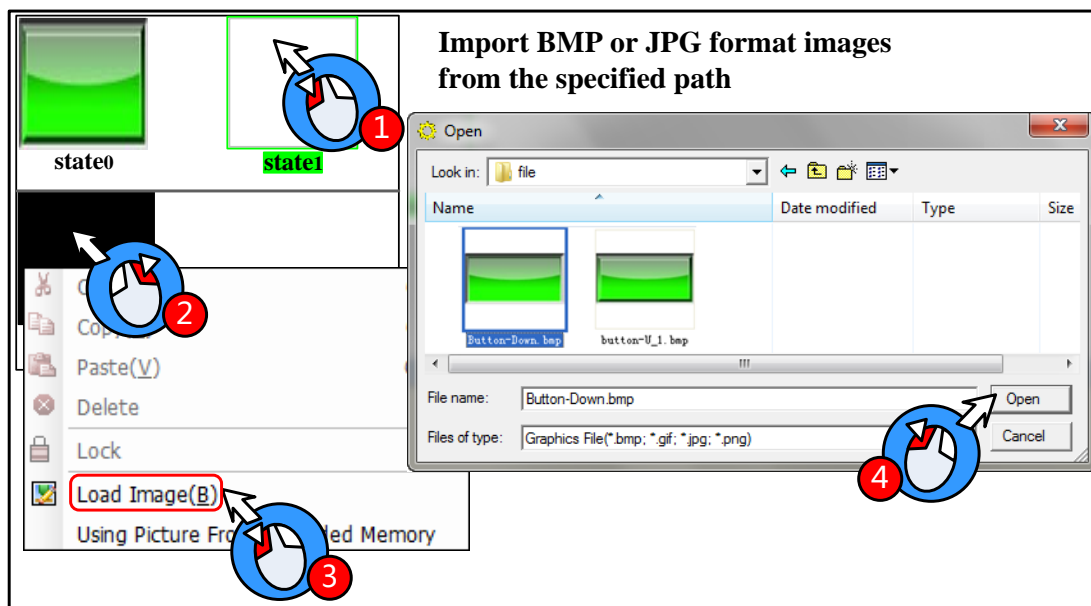

After import pictures to bit map, click on the Save in the File menu or the icon to save bit map, at last click on the icon to exit the graph edit window.

The new build bit graph will be saved as bg format file, it is saved in the vg file folder of current project file folder. The imported original bmp, jpg, gif pictures are saved in the image file folder of project file folder.



1. Do not delete any file in the vg file folder, or the vg/bg cannot display normally in the project.
2. User can only load external picture to bit graph, but cannot use draw tool to draw pictures or add text on it.
3. If user load gif format picture to bit graph, the gif cannot be controlled by component state, for example, if the Bit State Switch uses the gif picture, the component displays the gif animation effect, no matter the component is ON or OFF.

Kinco HMIware supports reading the pictures from extended memory devices to bit map; it can save the HMI memory.



Only the HMI with USB host and SD card port support reading picture from extended memory device.

Example: Put a picture (background.bmp) in the U disk or SD card (It is USB1 in this example), the HMI project read this picture (background.bmp) in the U disk.

1. Copy the picture (background.bmp) to the U disk.

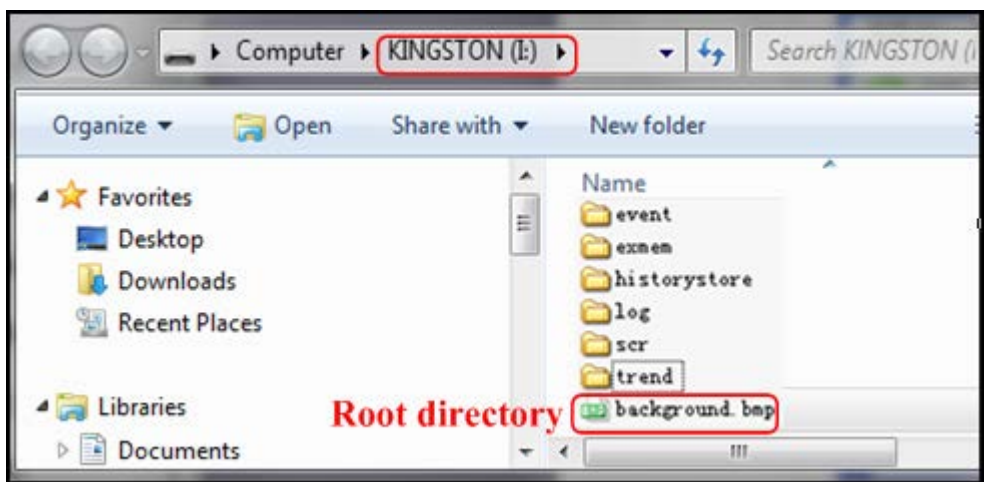

2. Build a new bitmap: Click on the icon  or the New Graphics(N) in the Draw(D) menu to pop up New Graphics dialog box: Name: background, State Num: 1, Type: Bitmap.

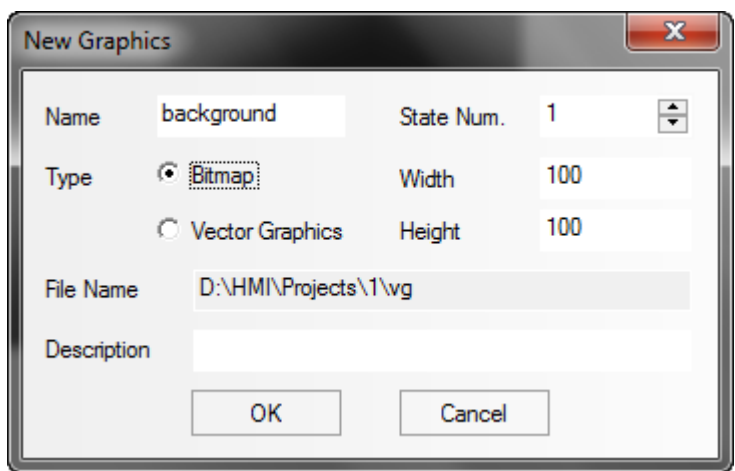

3. Using picture from extended memory

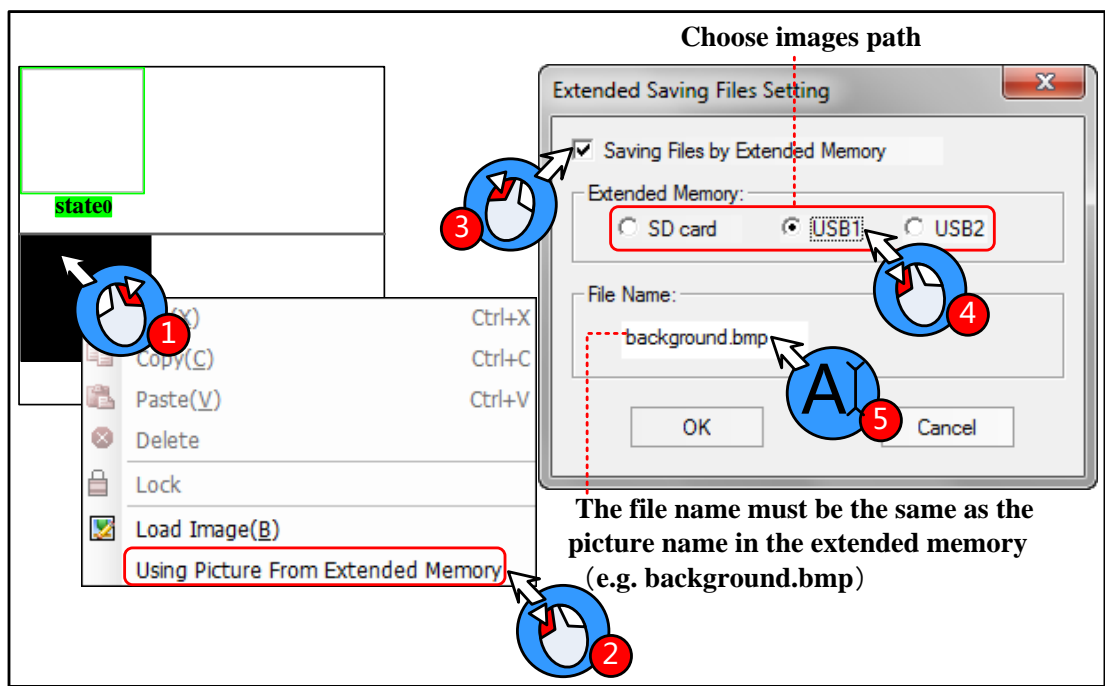



1. The File Name must be the same as the picture name in the extended memory.
2. The picture can be bmp, jpg or gif or png format.
3. The picture must be in the root directory of extended memory.

After above setting, click the icon to save the bitmap, and click on the icon at the upper right to close the graph edit window.

5.3.3 Edit Graphics

- How to open the Graph Edit Window

Open the Graph Edit Window as shown in following picture:

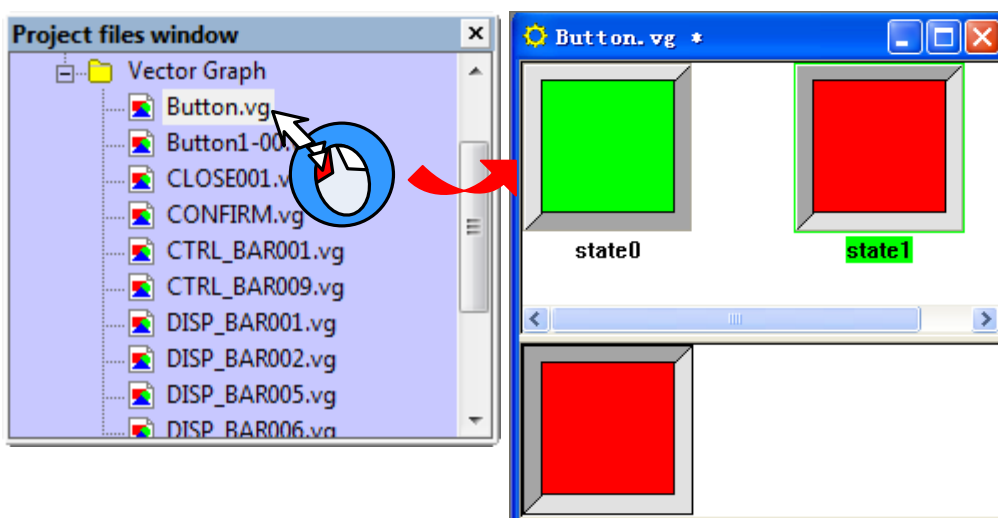

- Delete the graph

Delete the vg/bg graph in current project as shown in following picture:

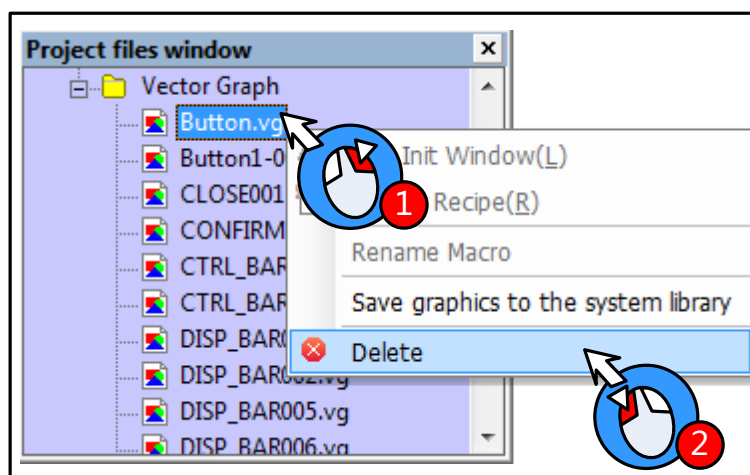

Click on the Yes to delete the chosen vg/bg, and click on the No to cancel this operation.

Add/delete states for graphics

User can add/delete graphics states in the Graph Edit Window.

Add state

(1) Add States in the right click options

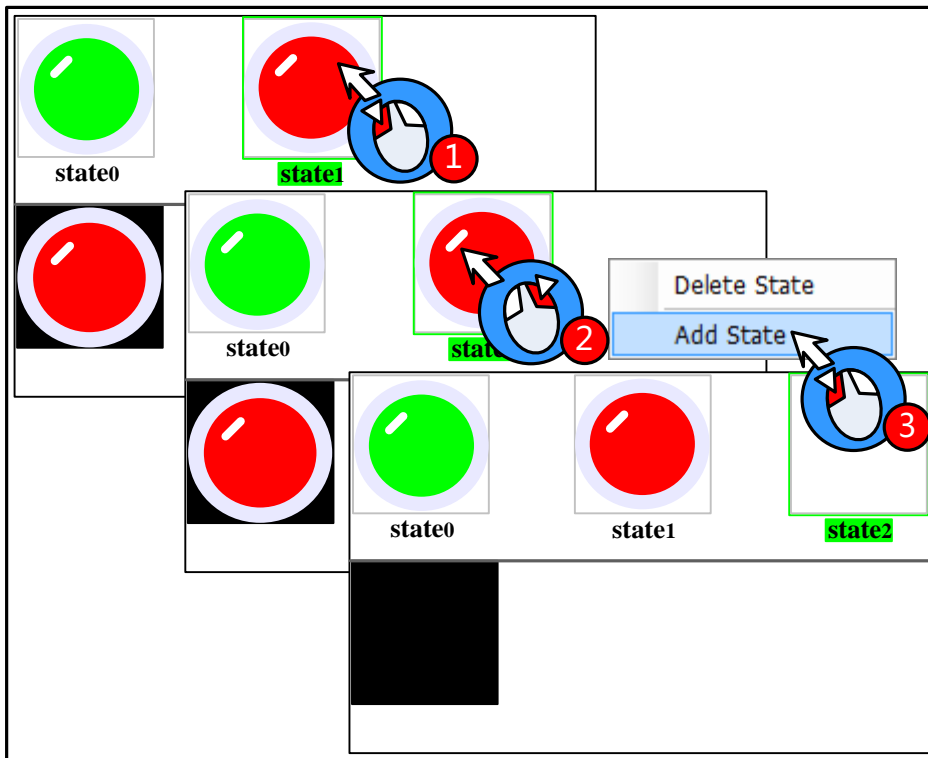



(2) The icon  in the tool bar: choose one state, and then click on the icon  to add state.

Delete States

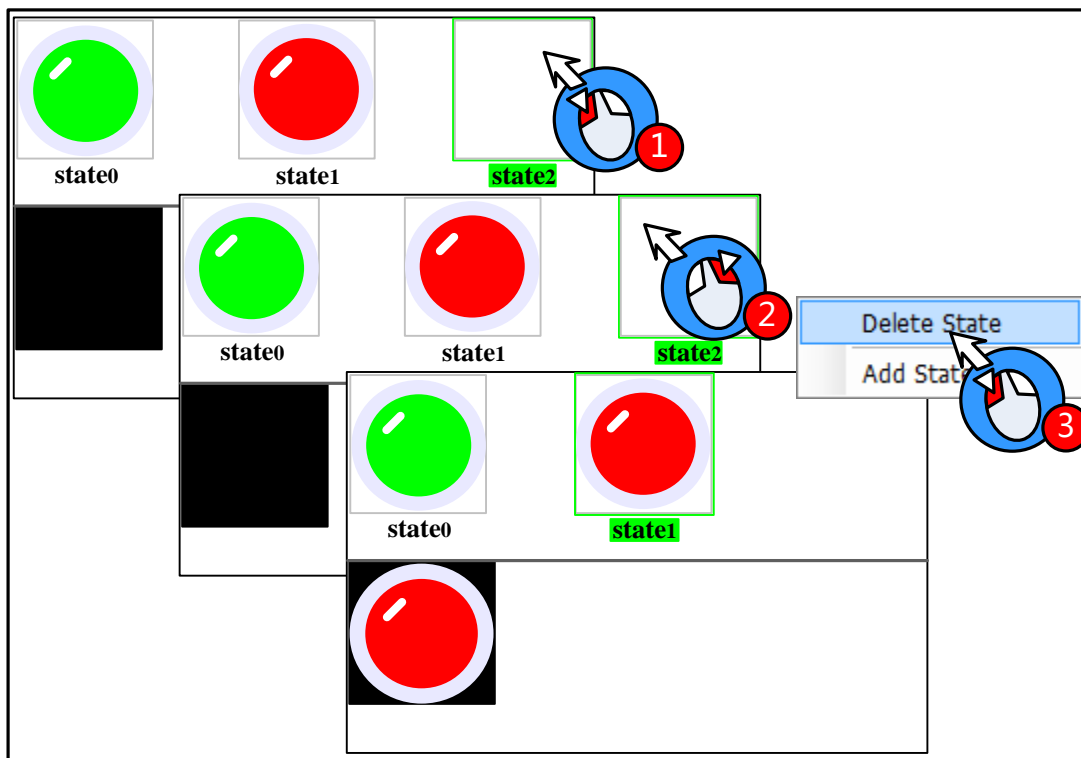

(1) Delete States in the right click options.



(2) The icon  in the tool bar: choose one state, and then click on the icon  to delete this state.



Delete States



The icons  and  are used to add/delete window in HMI Edit Window, and add/delete graph states in Graph Edit Window.

Zoom in/Zoom out edit area

In the graph edit window, it is not easy to edit graph if the edit area is too small, user can use the zoom in function to zoom in the edit area.

In the graph edit window, click on the icon  to zoom in the work space, the maximum is 300%; In the same way, click on the icon  to zoom out the work space, the minimum is 25%. See the 200% effect as follows:

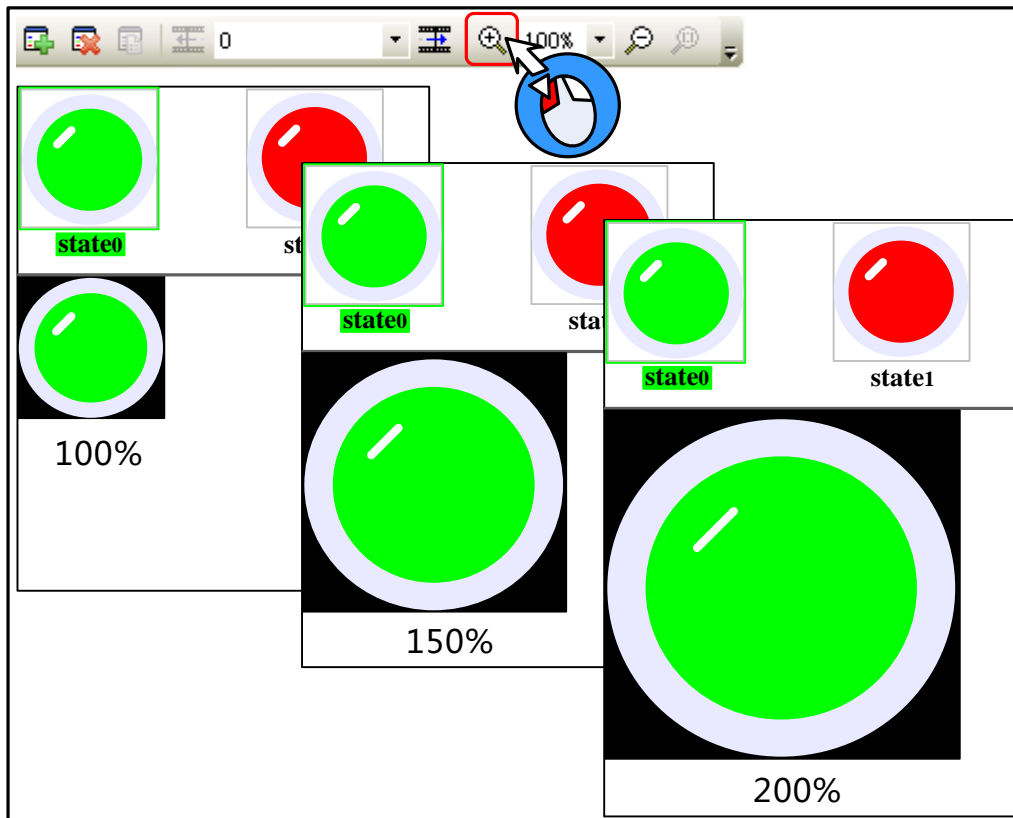

Gray level of graph

Click on the icon  to switch the gray level of current graph.

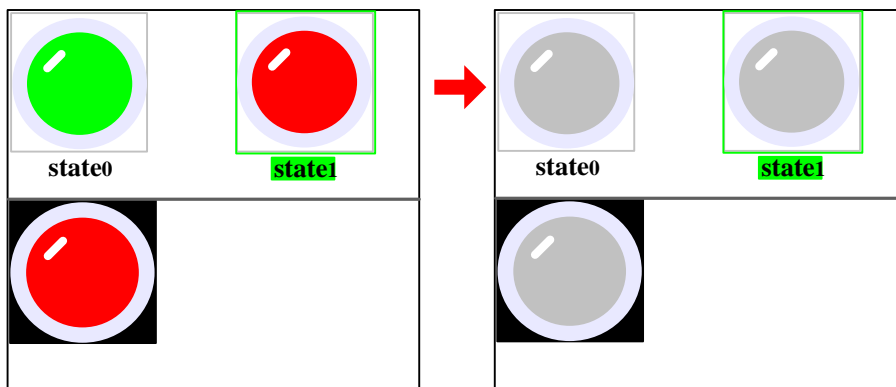

The transparent color of bit graph

[For details, refer to \[Advanced Part 2.2.6 About Transparent Color\]](#)

5.3.4 How to Use the Graphics

(1) How to use the vector and bit graphics.

Take the lamp, button and background pictures for example:

Add a Bit State Switch to the edit window, and use the Bitmap in Graphics option.

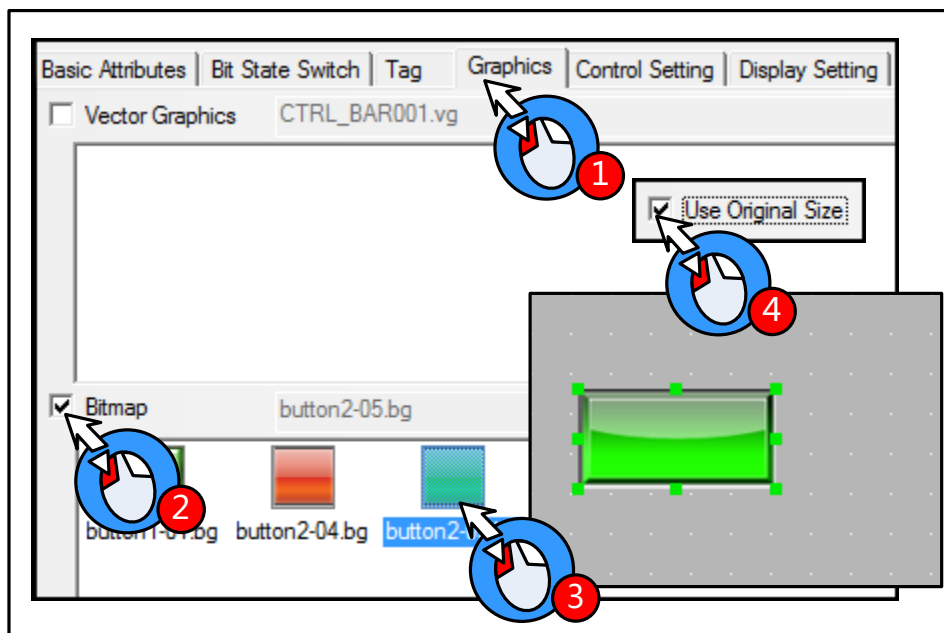

Add a Bit State Lamp, and use the Vector Graph in Graphics option.

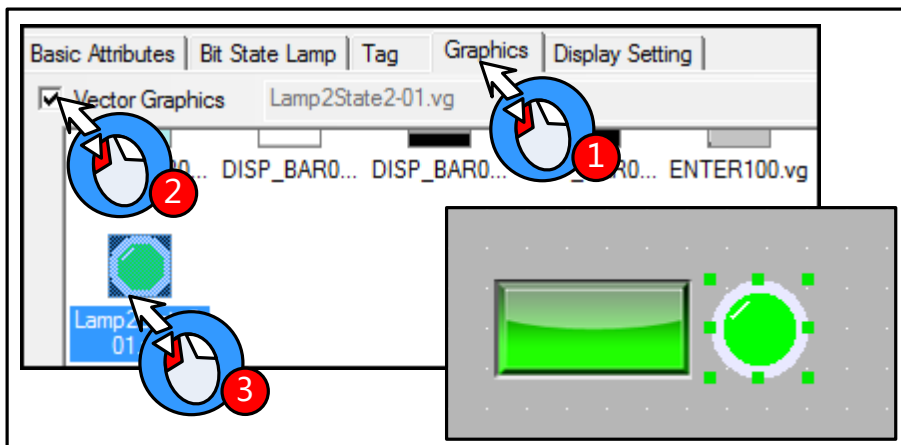

Add a Bitmap component as a background picture.

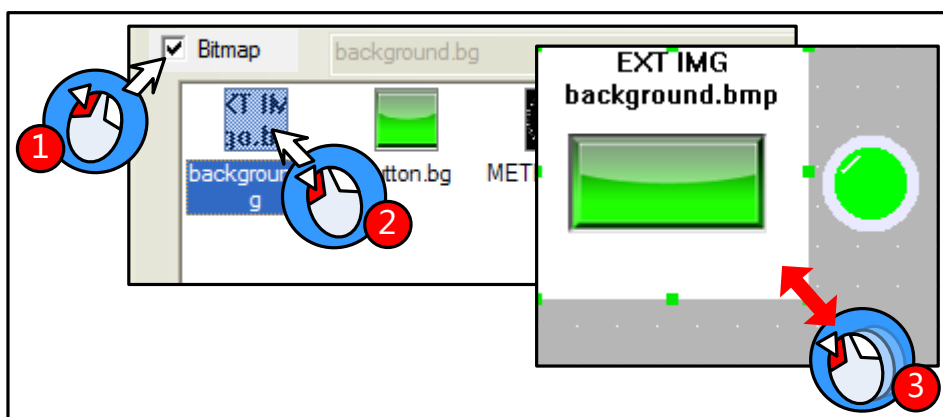

The bitmap which uses the picture from extended memory device does not support the “Use Original Size” function; user needs to adjust the size according to the original size himself.

The simulation effect is as follows:



(2)Optimize the bitmap

The bitmap supports the multiple formats picture, like BMP, JPG, JPE, JPEG, GIF, and PNG. But the color and size of imported pictures will affect the HMI project size and execution speed. Please note the following issues when you import a picture to the bitmap:

- The resolution of imported picture cannot be higher than HMI' s resolution, for example the HMI' s resolution is 640*480, and the imported picture' s resolution should be lower than 640*480. User can edit the picture to the same size as component by picture edit tool before importing this picture to the project, for example, a bitmap is used in a component with the width and height 100*100, and user can edit the picture to resolution 100*100 before importing this picture to bitmap. If you do not need the high resolution display, edit the picture as small as possible before importing, and then zoom in the program.
- The pictures saved in HMI are lossless compression in BMP format, if the imported pictures are loss compression in JPG, the pictures will be larger after compiling, and the resolutions will loss. That is, when using bit map. Please optimize the picture size, and chose compression format according to the actual application.
- Relatively Speaking, the vector graph takes much smaller size than bit map. That is, do not use too many bit maps in the program, use vector graphics as possible, it also can make HMI execute faster.

5.4 Sound Lib Application

Kinco HMIware supports sound files, like WAV, MP3 formats. They can be used for touch sound or Event/Alarm sound.



1. The audio output port does not support OPAMP function; user needs to connect a loud speaking to this port.
 2. A signal imported sound file must be smaller than 256K, but if the sound file is saved in extended memory, the size is not limited.
 3. Supports WAV and MP3 formats only.
 4. Only the HMI with audio output port support Sound Lib function.
-

5.4.1 Import Audio File

Click on the icon  or Graph element window>>Project Database>>Sound Lib to open the Sound Library box.

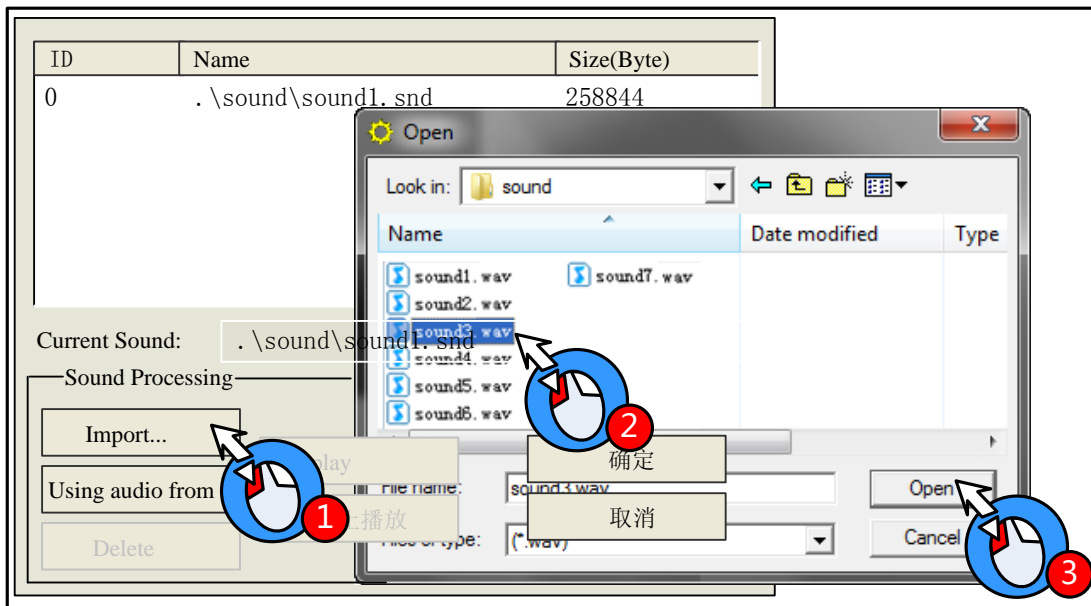

The system will convert the imported sound file to snd file automatically; the original sound file is saved in the sound file folder of current project file.

The sound file also can be read from extended memory, which can save HMI' s memory.

[Example]: Read the sound file named “sound4.mp3” from U disk. First, save the sound4.mp3 file to the root catalog of U disk.

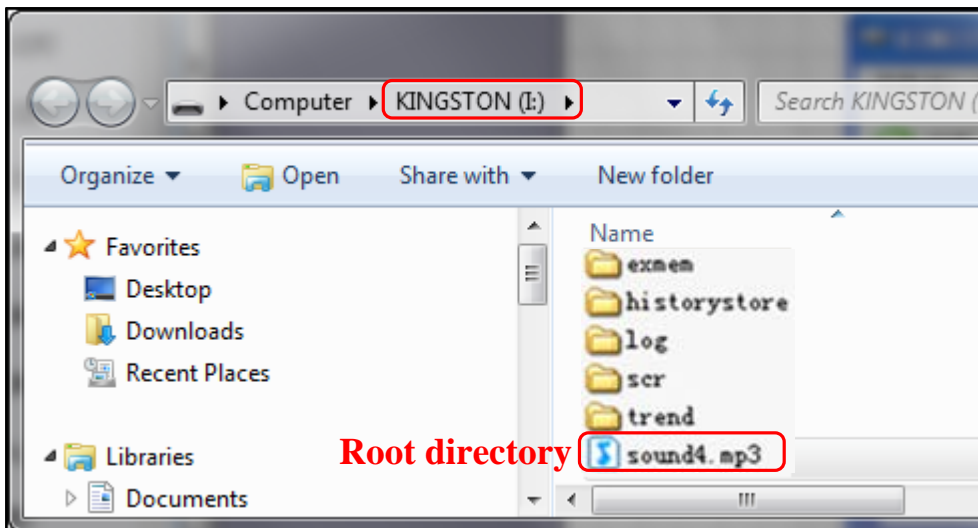

Choose the “Using audio from extended memory” in Sound Library.

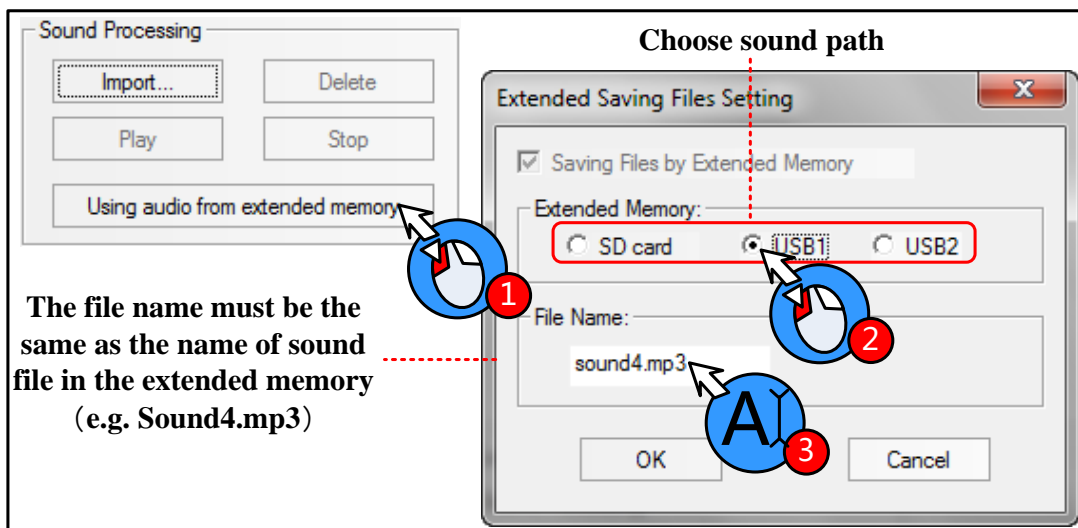

1. The File Name must be the same as the name of sound file in the extended memory.
2. The audio file read from extended memory must be mp4 format, the wav is not supported.
3. The audio file must be saved in the root catalog of extended memory.
4. The size of audio file is not limited , it depends on the memory size of extended memory device.

5.4.2 How to Use Audio File

(1)How to use audio file

Only the HMI with audio output port has the Sound option in component attributes. The audio file will be played till the it is over when the component is touched, and this sound cannot be paused.

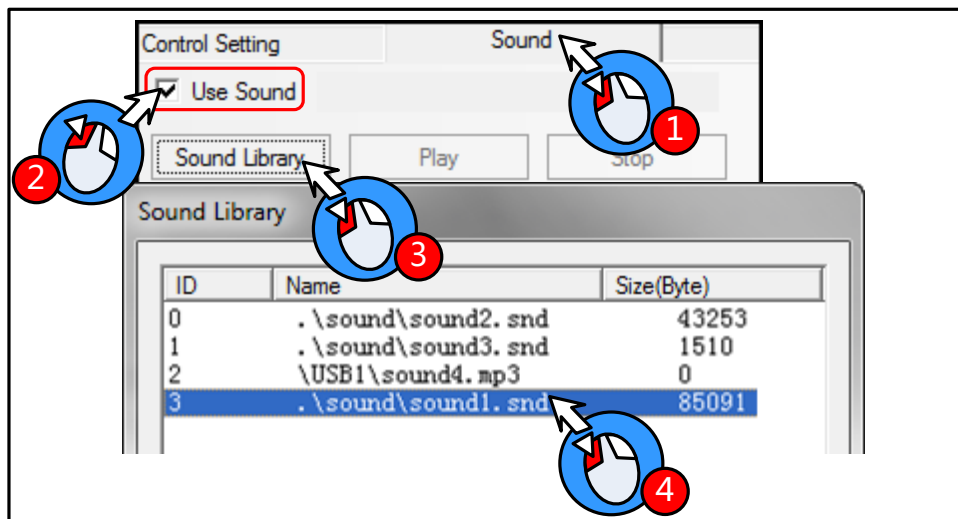

The Alarm/Event Information also can use the sound as the alarm sound.

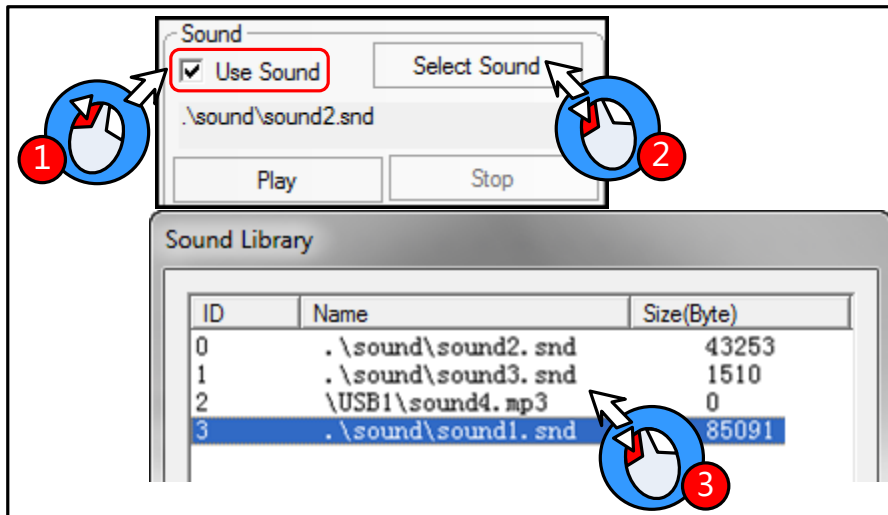

(2) Adjust the audio volume

User can use the system register LW9464 to adjust the volume, if LW9464=0, it means sound off. The value of LW9464 is from 1 to 100, which means the volume is larger.

6 System Parameters

6.1 HMI Attributes

Double the HMI icon or right click the HMI icon and choose the Attribute to open the HMI Attributes box. User can configure some HMI system parameters in this box.

6.1.1 HMI

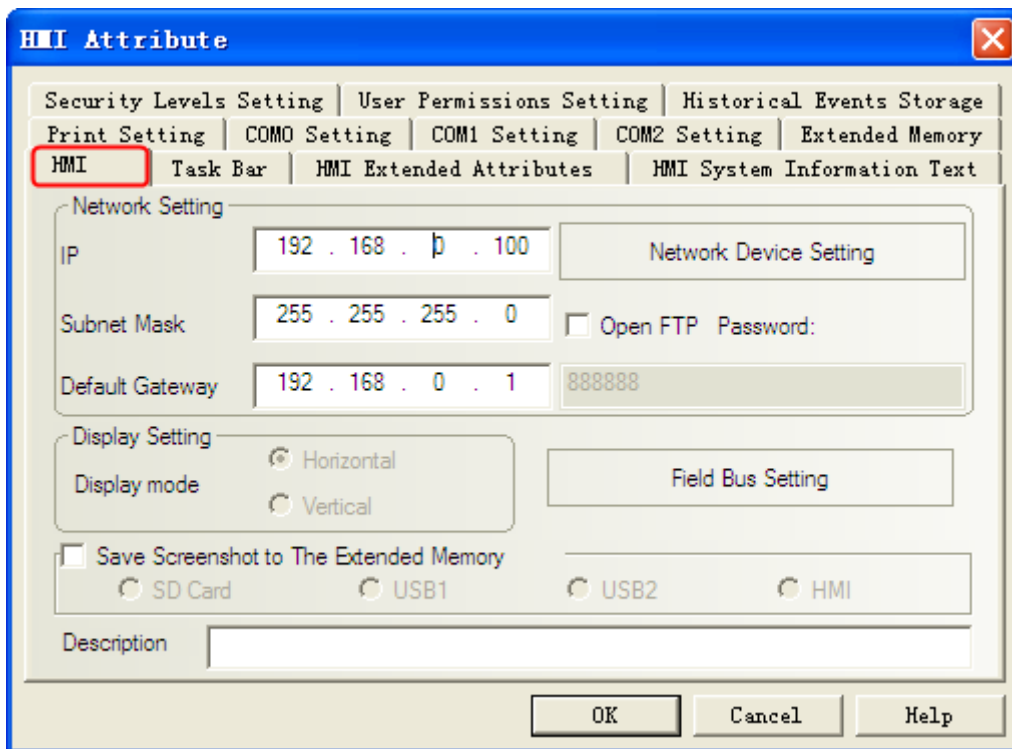

Detail description of HMI Attributes option

Network Setting	IP	Set the IP address for the HMI with Ethernet port
	Subnet Mask	Set the subnet mask for the HMI with Ethernet port
	Default Gateway	Set the gateway of LAN which HMI is connected to
	Open FTP	Enable the FTP function and set a password. For details, refer to [Advanced Part 14.2.4 FTP Function]
	Network Device Setting	Configure the Ethernet protocol when HMI communicates with PLC/controller via Ethernet
Display Setting	Display the HMI display mode	
Field Bus Setting	Configure the field bus protocol and parameters when HMI communicates with PLC/controller via field bus	
Save Screenshots to The Extended Memory	Choose the extended memory device where the screenshots are saved. Only the HMI with extended memory supports this function	

Description	Input description for HMI , this description will distinguish different HMI when downloading and simulating
-------------	---

6.1.2 Task Bar

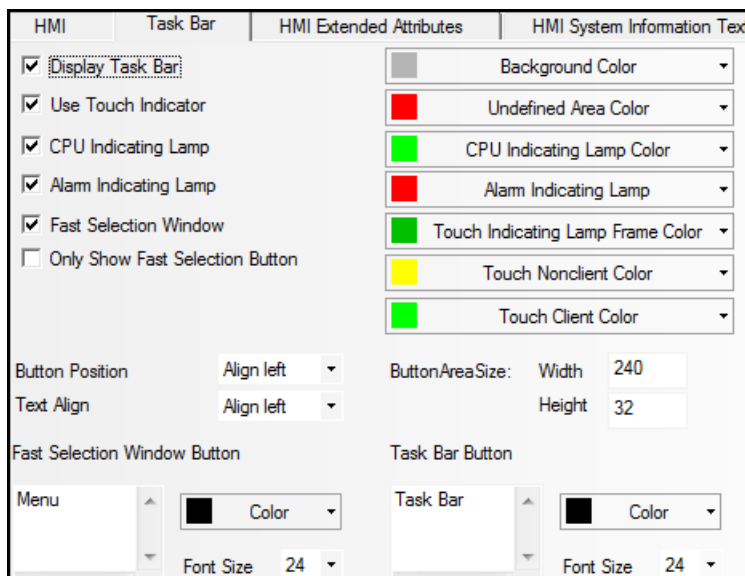

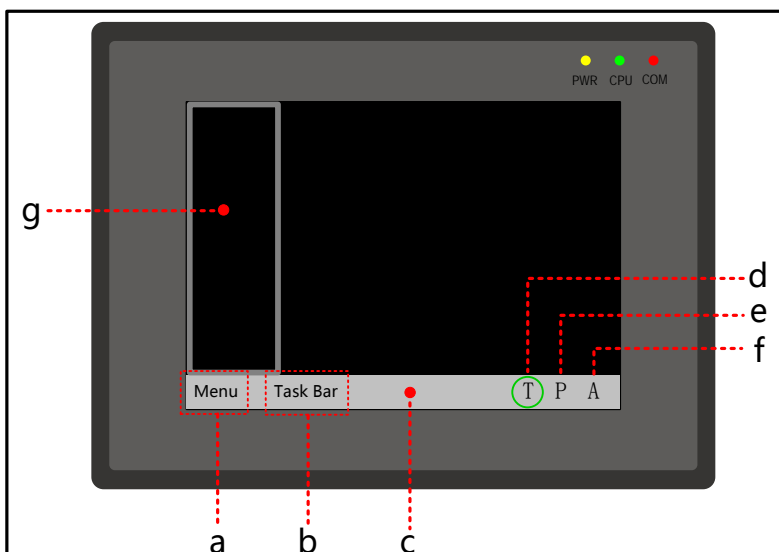

The display effect on HMI is as follows:

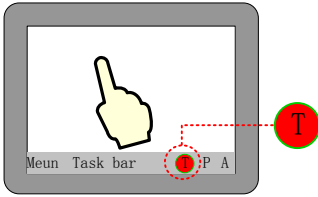
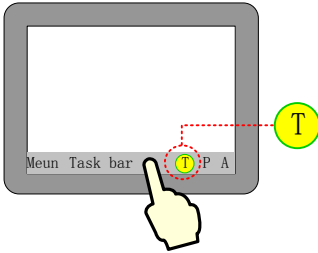
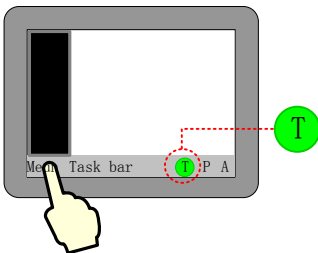

- a. Fast Selection Window button b. Task Bar button c. Task Bar d. Touch Indicator e. CPU Indicator f. Alarm Indicator g. Fast Selection Window

Detail Descriptions of Task Bar	
Display Task Bar	Display the task bar on HMI or not <div style="display: flex; justify-content: space-around;"> <div style="text-align: center;"> <p>Display</p> </div> <div style="text-align: center;"> <p>Not display</p> </div> </div>

Use Touch Indicator	Display touch indicator on tool bar.	
	Undefined Area Color	<p>Set the indicator color when touching the undefined area.</p> 
	Touch Nonclient Color	<p>Set the indicator color when touching the blank area, where there are no components orders.</p> 
	Touch Client Color	<p>Set the indicator color when touching the workplace area, where there are components and orders.</p> 
Touch Indicating Lamp Frame Color	Set the color for indicator frame.	
CPU Indicating Lamp	Display CPU indictor on task bar.	
CPU Indicating Lamp Color	Set the color for CPU indicating lamp.	
Alarm Indicating Lamp	Display alarm indictor on task bar.	
Alarm Indicating Lamp	Set the color for alarm indicating lamp.	
Fast Selection Window	When clicking on the Menu button , pop up the fast selection window or not.	
Only Show Fast Selection Button	Set this option to display fast selection button only.	

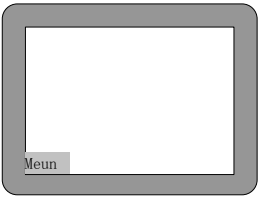
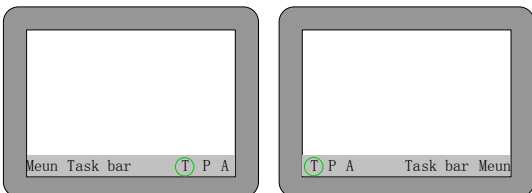
	
Button Area Size	Set the size of buttons on fast selection window and task bar, the unit is pixel.
Font Size/Color	Set the font size and color of text on fast selection window and task bar, the unit is pixel.
Button Position	<p>Set the position of buttons on fast selection window and task bar.</p> <p>Align left Align right</p> 
Text Align	Set the align method of text on fast selection window and task bar.
Hide the buttons of fast section window and task bar	Delete the text in the text box to hide the buttons.

6.1.3 HMI Extended Attributes

Backlight mins Video Mode

Backlight automatically turns when the alarm / event occurs

Screen Saver mins The Window Of Screensavers

Return to Original Window when Screensavers Ends Number of Language

Allow Upload Password Default Language

Allow Decompilation Password

Use DownLoad Password

User defines datalogger's channel description

Chinese Font Box Height

System Scroll Bar Width

Use INIT Macro

Use External Time for Datalogger

Use External Time for Event

Vector Fonts Edge Blur

Screen Flip Display

Use Buzzer

Invalided Components Color

Operational Records Storage Setting

Storage Devices

Subdirectory

Storage Type

Bulk Storage Save MS

Max Storage Days

Note: there is no limit when The max storage is zero.



Public Window Attributes

Pop-up Window Attributes

Initial Window File Browser Window

Public Window Operation Con- firmation Window

Fast Selection Window Login Window

Back Light/Screen Saver Setting			
Backlight	HMI turns off the backlight if there is no touch within set time, and the backlight will turn on when the HMI screen is touched again. The unit of set time is minute, and the default time is 10 minutes.		
	<table border="1"> <tr> <td>Backlight automatically turns when alarm/event occurs.</td> <td>In the backlight off state, The backlight will turn on automatically if alarm or event is triggered.</td> </tr> </table>	Backlight automatically turns when alarm/event occurs.	In the backlight off state, The backlight will turn on automatically if alarm or event is triggered.
Backlight automatically turns when alarm/event occurs.	In the backlight off state, The backlight will turn on automatically if alarm or event is triggered.		
Screen Saver	HMI displays the screen saver window if there is no touch within set time, user can set the screen saver window in the Window of Screensavers. HMI will display the normal screen again if the screen is touched in screen saver mode. The default screen saver time is 10 minutes.		
	<table border="1"> <tr> <td>The Window of Screensavers</td> <td>Select a window as screensaver screen picture.</td> </tr> </table>	The Window of Screensavers	Select a window as screensaver screen picture.
	The Window of Screensavers	Select a window as screensaver screen picture.	
<table border="1"> <tr> <td>Return to Original Window when Screensaver Ends.</td> <td>If this option is checked, the HMI returns to original window when screensaver ends, if it is not checked, HMI goes to the screensaver window when screensaver ends.</td> </tr> </table>	Return to Original Window when Screensaver Ends.	If this option is checked, the HMI returns to original window when screensaver ends, if it is not checked, HMI goes to the screensaver window when screensaver ends.	
Return to Original Window when Screensaver Ends.	If this option is checked, the HMI returns to original window when screensaver ends, if it is not checked, HMI goes to the screensaver window when screensaver ends.		
Upload/Decompile function settings			
Allow Upload	<p>Allow user uploads the project in HMI to PC, the default password is 888888. Note: the Password can not be empty or 0.</p> <p> For details, refer to [Advanced Part 8.4 Upload]</p>		
Allow Decompile	<p>Allow user decompile the pkg file to wpj file, which Kinco HMIware can edit, the default password is 888888. Note: the Password cannot be empty or 0.</p> <p> For details, refer to [Advanced Part 8.7 Decompile Operation]</p>		
Use Download	<p>Allow user download the pkg file to HMI, the default password is 888888.</p> <p> For details, refer to [Advanced Part 10.1.4 Download Password Protection]</p>		
Video function settings			
Video Mode	Set the signal format of video input, the PAL and NTSC are optional. Only the HMI with BNC port supports this function, and uses the Video component in the program.		
Text library settings			
Number of Language	Set the language number in the Text Library, there are 32 languages at most. This function is used together with Text Library.		
Default Language	The default display language of the texts which use text library. This function is used together with Text Library.		
Language Setting	Open the Language Setting dialog box .This function is used together with Text Library.		
System function setting			

Use INIT Macro	Trigger the macro when HMI is powered on.		
Use Buzzer	Enable the buzzer in HMI		
Screen Flip Display	Display a 180 degrees turn over screen.		
Auxiliary parameters setting			
System Scroll Bar Width.	Set the width of system scroll bar, it ranges from 20 to 120, the unit is pixel.		
Chinese Font Box Height	Set the height of Chinese character input box, it ranges from 24 to 99, and the unit is pixel. This function is used when input Chinese character to Text Input component.		
Invalided Components Color	Set the color of invalid components, this function is used together with component which is set the Conditional Enabling option.		
Cursor Color	Set the cursor color in the input status of Number/Text Input component.		
Use External Time for Datalogger	Set the time source of the data sample in Datalogger and Data Report. For details, refer to [Advanced Part 2.7.3 System Time and PLC Time Synchronization]		
Use External Time for Event	Set the time source of Event Trig time and Return to Normal Time in the Event Display and Event Bar. For details, refer to [Advanced Part 2.7.3 System Time and PLC Time Synchronization]		
User defines datalogger's channel description	Set the description in created *.db file same as the sample channel description.		
Operational Records Storage Settings	Storage Devices	The SD, USB DISK1*, USB DISK2* , HMI are optional.	
	Save MS	Save the millisecond of operation log and save them in the CSV file.	
	Subdirectory	Set the subdirectory where CSV file is storage, user can modify it. The default subdirectory is Record.	
	Storage Type	Daily File	Save the daily operation log in CSV file, the file name is named by date, "yyyy mmdd".
		Single File	Save the every recodes of operation log in CSV file, the filename is the Subdirectory.
	Bulk Storage	Select a cache mode, when the data in buffer memory reaches the set size; write data to SD card or USB drive. The Default means no buffer memory, data is write to SD card or USB drive directly.	
Max Storage	Set the upper limit of storage. The unit of Daily File is Day , and the unit of Single File is item If the Storage Type is Daily File, the CSV file is named as		

	“yyyymmdd”and the Max Storage is upper limit of CSV file number in this route. The early file will be delete if the file number exceeds the Max Storage; If the Storage Type is Single File, The file is named as Subdirectory, the Max Storage means the upper limit of the item number in this file, if item number exceeds the Max Storage , the data will not be stored any more.(yyyymmdd means the date when the operation log happens)
--	---

Related Settings of Window	
Public Window Attributes	Display Public Window above the basic window or below the basic window
Pop_up Window Attributes	Display pop-up window on the top or not
Initial Window	Set the first window when HMI is powered on. The default is [0:Frame0]
Public Window	Set a window as Public Window. The default is [1: Common Window]
Fast Selection Window	Set a window as Fast Selection Window, The default is [2:Fast Selection]. The Fast Selection is used together with the fast selection button in the task bar.
File Brower Window	Set a window as File Brower Window, The default is[5:File List Window]. The File Brower Window is used together with the Import/Export in Function Key.
Operation Confirmation Window	Set a window as Operation Confirmation Window, the default is [7: Confirm Action Window].The Operation Confirmation Window is used together with Operator Confirm of a component.
Login Window	Set a window as Login Window of User Permission and Security Level, the default is [9:Login Window]. The Login Window is used together with the User Permission and Security Level function.

※Some models have two USB Host ports; the number of USB DISK is according to the sequence when the USB drives are plugged in HMI, but not the position of the USB slot. The USB drive which is plugged in first is the USD DISK1 and the second one is USB DISK2.

6.1.4 HMI System Information Text

User can define the display content for the system error information in the User-Defined System Information. When the error happens, if user defines the display content for system error, HMI will display the user-defined content, or HMI displays the default system error information.

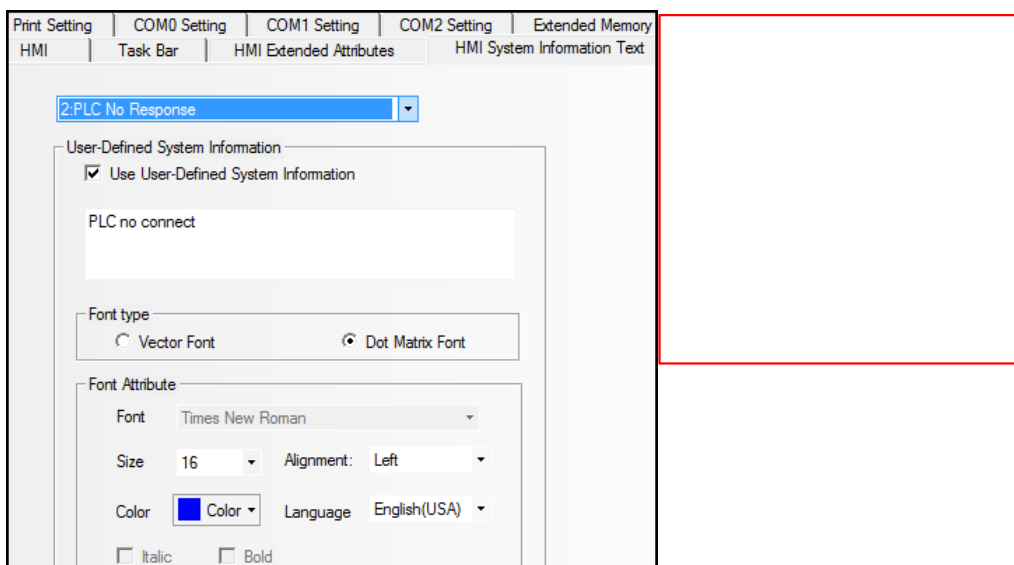
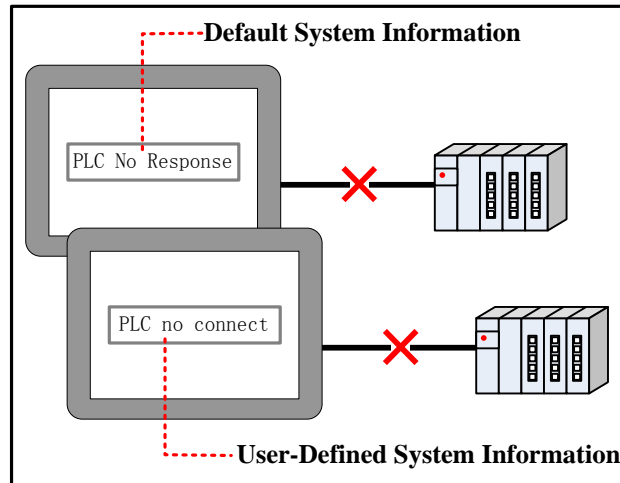

Select the default system error information in the red frame, then check the Use User-Defined Information and input user-defined content in the input box.



User can define multiple system error information

6.1.5 Security Levels Setting

In this option, user can set the security levels and their passwords. There are 16 levels at most

[For details, refer to \[Advanced Part 10 Password\]](#)

6.1.6 User Permissions Setting

In this option, user can configure user name, password, logoff time and permission and so on. There are 32 users at most, and each user has 32 permissions at most.

[For details, refer to \[Advanced Part 10 Password\]](#)

6.1.7 Historical Events Storage

In this option, user can set the route where the historical events are stored; this function is used together with Event components.

[For details, refer to \[Advanced Part 4.7 Alarm Component\]](#)

Descriptions of Historical Events Storage		
Save to	Save the historical event information in the recipe memory.	
Recipe Data Field	Save Count	Set the item number of historical events, which are saved in recipe memory. If the event item is larger than the set Save Count, the early information will be deleted, and save new information. Note: If the Save Count is 0, the historical event will not be stored.
	Start Addr	Set the start address from which the historical events are stored in recipe memory.
	End Addr	Software will calculate the End Address according to the Save Count and Start Addr.
Save to	Save the historical event information to external devices.	
External Device	Storage Devices	The SD card, USB DISK1*, and USB DISK2* are optional.
	Outage Keepin	When HMI is restarted by power outage, HMI can recover 1024 items historical event which are triggered before power outage, and display them in the Event Display component.

Export to CSV file	Save the historical event information in CSV file, and save this CSV file to external memory device, the storage route is :/event/subdirectory name/file name	
Save MS	Save the millisecond of operation log and save them in the CSV file.	
Subdirectory	Set the subdirectory where CSV file is storage, user can modify it. The default subdirectory for historical event is Event.	
Storage Type	Daily File	Save the daily historical event information in CSV file, the file is named by date, "yyyy mmdd".
	Single File	Save the every recodes of operation log in CSV file, the filename is the Subdirectory.
Bulk Storage	Select a cache mode, when the data in buffer memory reaches the set size; write data to SD card or USB drive. The Default means no buffer memory, data is write to SD card or USB drive directly.	
Max Storage	Set the upper limit of storage. The unit of Daily File is Day , and the unit of Single File is item If the Storage Type is Daily File, the CSV file is named as "yyyymmdd"and the Max Storage is upper limit of CSV file number in this route. The early file will be delete if the file number exceeds the Max Storage; If the Storage Type is Single File, The file is named as Subdirectory, the Max Storage means the upper limit of the item number in this file, if item number exceeds the Max Storage , the data will not be stored any more.(yyyymmdd means the date when the operation log happens)	

6.1.8 Print Setting

In the Print Setting option, user can enable print functions and set its parameters.

Security Levels Setting	User Permissions Setting	Historical Events Storage
HMI	Task Bar	HMI Extended Attributes
HMI System Information Text	Print Setting	COM0 Setting
COM1 Setting	COM2 Setting	Extended Memory

Enable Print

Printer: HP PCL5e Port: USB Host

Baud Rate: 9600 Data Bit: 8 Parity Check: none Stop Bit: 1

Printer Paper: A4(210.0mm*297.0mm)

Network Printer Setting

IP: 192 . 168 . 0 . 101 Port: 8000

Print Setting of Event Display

<input type="checkbox"/> Print Sequence No.	<input type="checkbox"/> Network Printing
<input type="checkbox"/> Print Time	<input type="checkbox"/> Print Date
<input type="checkbox"/> Print Extended Time(d:h:m)	<input type="checkbox"/> Print Extended Date(yyy/mm/dd)
<input type="checkbox"/> Print Standard Time(h:m:s)	<input type="checkbox"/> Check Window Errors
<input type="checkbox"/> Print Precise Time(h:m:s:ms)	

Descriptions of Printing Setting		
Enable Print	Enable print function of HMI	
	Printer	Select a communication protocol for printer For details, refer to [Advanced Part 13 Print]
	port	Select a communication port for HMI and printer
	Baud Rate/Data Bit/Parity Check/Stop Bit	If the printing port is serial port, set the corresponding parameters of serial port
Net Print Setting	IP	The IP address of the PC which connects to the network printer in the LAN
	Port	The port of the PC which connects to the network printer in the LAN
Print Setting of Event Display	Print Date	Print the date when the event is triggered and returns to normal. Format:mm/dd
	Print Standard Time(h:m:s)	Print the standard time when the event is triggered and returns to normal, If this option is checked the Print Time will be checked automatically. Format: h:m:s
	Print Sequence NO.	Print sequence NO. of event
	Print Extended Date(d:h:m)	Print the extended date when the event is triggered and returns to normal, If this option is checked the Print Date will be checked automatically. Format: yyyy/mm/dd
	Print Precise Time(h:m:s:ms)	Print the precise time when the event is triggered and the returns to normal, If this option is checked the Print Time will be checked automatically. Format: h:m:s:ms
	Print Time	Print the time when the event is triggered and the returns to normal. Format: m:s
	Print Extended Time(d:h:m)	Print the extended time when the event is triggered and the returns to normal, If this option is checked the Print Time will be checked automatically. Format: h:m:s:ms. Format: d:h:m
	Check Window Error	Check if there is error in this window when printing
	Network Printing	Enable the Network Printing function

[For details, refer to \[Advanced Part 13 Print\]](#)

6.1.9 Serial Port Setting

In the CMO0/1/2 Setting, user can set the HMI communication parameters when HMI communicates with PLC.

Security Levels Setting		User Permissions Setting		Historical Events Storage	
HMI	Task Bar	HMI Extended Attributes		HMI System Information Text	
Print Setting	COM0 Setting	COM1 Setting	COM2 Setting	Extended Memory	
Type	RS232	PLC Communication Time Out		3	
Baud Rate	9600	Protocol Time Out 1(ms)		3	
Data Bit	8	Protocol Time Out 2(ms)		3	
Parity Check	none	Max interval of word block pack		2	
Stop Bit	1	Max interval of bit block pack		2	
<input type="checkbox"/> Broadcast	65535	Max word block package size		32	
		Max bit block package size		64	
Use Default Setting					

Descriptions of COM0/1/2 Setting

Type	Select a communication type when HMI communicates with PLC, the RS232 (RS-232C), RS485-2(RS-485), RS485-4(RS-422A) are optional. Note: the COM2 only supports the RS232(RS232C)
Baud Rate/Data Bit/Parity Check/Stop Bit	Set the HMI communication parameters when HMI communicates with PLC For details, refer to [Advanced Part 14 HMI Communication]
Device No.	When HMI works as a slave device, set the HMI station number.
Broadcast	When HMI works as MODBUS RTU master, HMI only sends command to PLC, but ignores any response from PLC. The Broadcast can only be 0.
PLC Communication Time Out	The time HMI waits response from PLC/controller, unit is millisecond or second. If PLC/controller has no response within this time, it is time out; HMI gives up this request and try the next request. If there is no response after several requests, HMI display PLC no response. Do not suggest customers to modify this parameter.
Protocol Time Out1(ms)	Time out of character. The protocol takes this time as time interval to cut frame; In other words, it is the max time interval between each character. If the communication is not stable, user can increase this value to improve the communication. It ranges from 1 to 500. This parameter is set when you connect a PLC to HMI port in the software. Do not suggest customers to modify this parameter.
Protocol Time Out2(ms)	E5time out, the communication speed will be slow, but the communication error and error package will also be reduced. This value cannot exceed 100. Do not suggest customers to modify this parameter.
Max Inter of bit/word block pack	These parameters decide that how many registers can be read in a package when the registers are not continual. Do not suggest customers to modify this parameter.

Max word block word/bit package size	These parameters decide the max length of package. That is, how many the registers that can be read as one frame at a time. Do not suggest customers to modify this parameter.
Use Default Setting	If users modify the default communication parameters, and HMI and PLC does not communicate successfully, they can use this button to set the parameters to default value.

6.1.10 Extended Memory

In the Extended Memory option, user can define address type ERW0, ERW1, ERW2 in the extended memory devices, USB drive or SD card.

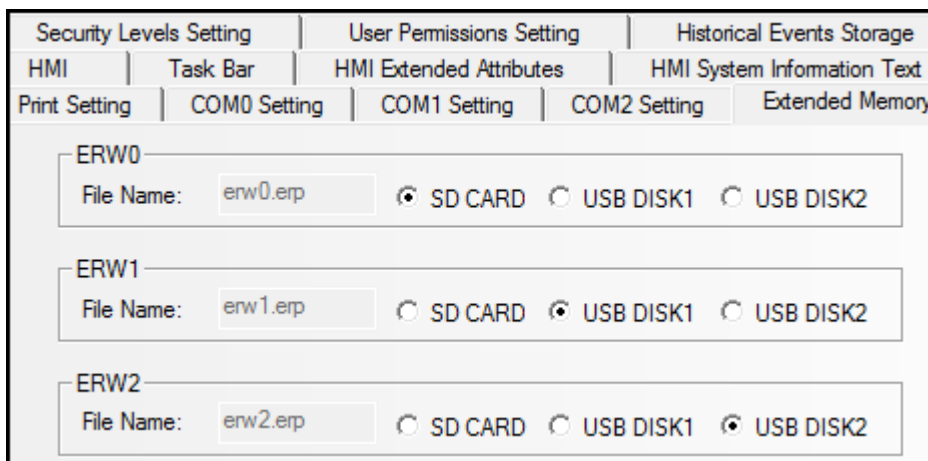

The ERW data will stored in the extended memory in erp file, its route is /xmem/erw.erp, (x=0, 1, 2)

6.2 PLC Attribute

In the Construct window, double click PLC icon or right click PLC icon and choose the Attributes to open the PLC Attribute option. User can configure PLC communication parameters

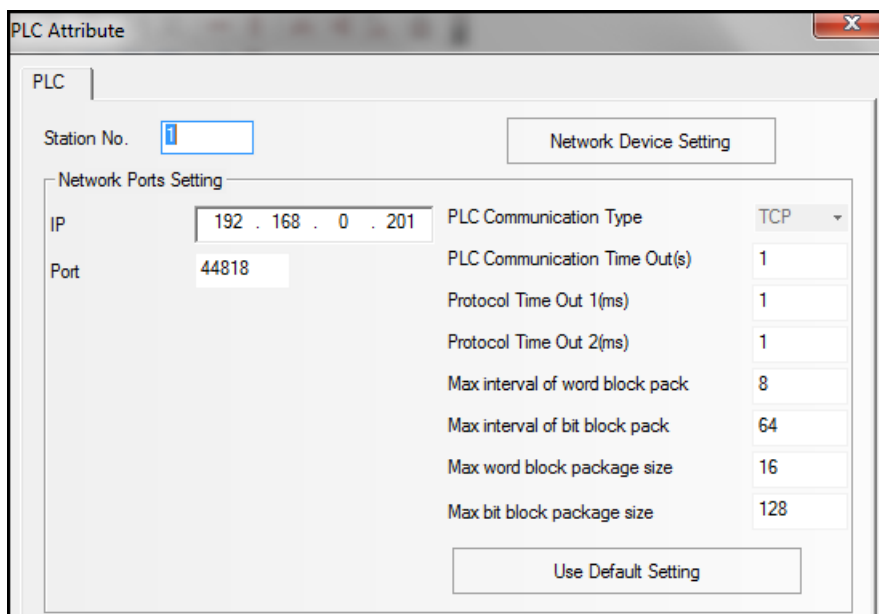

PLC Attribute Description



Station No.	When PLC/controller works as slave device, set the station No. for PLC/controller.
Network Device Setting	When HMI communicates with PLC/controller via Ethernet, configure the Ethernet protocol and communication parameters here.
IP Address	Set the IP address for PLC/controller.
Port No.	Set the port No. for PLC/controller.
PLC Communication Time Out.....Use Default Setting	 For details, refer to [Advanced Part 6.1.9 Serial Port Setting]

7 Compile/Simulate/Download/Upload

7.1 Compilation

Compilation can be divided into: **【Compile】** , **【Compile All】** , **【Clear Build Result】** .

7.1.1 Methods of Compilation

Click the    icons in toolbar , or select **【Compile】** / **【Compile All】** / **【Clear Build Result】** in the **【Tools】** menu.



Name	Description
Compile	When there are Macro files in the project, click 【Compile】 will do not compile the Macro files that has been compiled
Compile All	Compile all the files
Clear Build Result	Clear all the compiled files, including .pkg files, Macro files .so/.dll, .hmi files, .logo files

7.2 Simulation

Kinco HMIware supports 3 modes of simulation: Offline Simulation, Indirect Online Simulation, Direct Online Simulation

Name	PLC/Controller	HMI	Description
Offline Simulation	—	—	Connections with PLC and HMI are not needed, so the time for each download is shortened significantly. But the program cannot acquire data from the PLC, only read data from the local address. Therefore all data displayed on the configuration windows are static data
Indirect Online Simulation	√	√	Need to connect PLC and HMI. PLC data can be obtained dynamically. The operating environment of the program is the same as downloaded into HMI, but does not need to download the project to HMI repeatedly, which is quickly and convenient
Direct Online Simulation	√	—	Only PLC needs to be connected, while HMI doesn't. PLC data can be obtained dynamically. This mode can be used to check whether communication is normal without connecting with an HMI

7.2.1 Modes of Simulation

Click the    icons in toolbar , or select **【Offline simulation】** / **【Indirect Online Simulation】** / **【Direct Online Simulation】** in the **【Tools】** menu. Select an HMI to be simulated, and click **【Simulation】** to start simulation.



1. The maximum test time for the direct online simulation is 15 minutes. After 15 minutes, the system will prompt “Online Simulation overtime and Program is end, if want, Please Simulate again.”
2. Mostly only the RS232 communication mode can be used for direct online simulation. Some PLCs

communicating through Ethernet port can execute direct online simulation through Ethernet port.

3. Connection of direct online simulation for RS232 communication: program cable of PLC connects with the serial port of PC directly. Connection of direct online simulation for Ethernet port communication mode: connect directly through cross-over cable or through a Switch.

4. The port used for direct online simulation cannot be used by other programs, otherwise, communication will fail when simulating.

7.2.2 Exit Simulation

To exit simulation by the space key of the keyboard, or click the right mouse button in the simulation box blank, select **【Close】** to exit simulation.

7.3 Download

Kinco HMIware provides 3 ways of download: USB, Serial port, Ethernet port (Download via Ethernet port is only suitable for HMIs with Ethernet ports).

7.3.1 Download Method Selection

Click the  icon in toolbar, or select from **【Tools】** menu— **【Download Method】**:

The Properties dialog box of **【Project Setting Option】** pops up, the default download method is via USB port, single click the drop-down list of **【Download Method】** to select download way.



1. Download way is saved according to HMI. For example: there are 2 HMIs in a project, HMI0 and HMI1. The download way of HMI0 is via serial port before closed, and HMI1 is via USB cable before closed. Then open the project again, download way of HMI0 is still via serial port, and HMI1 is still via USB cable.

2. When USB downloading cable is used for the first time, the USB device driver should be installed manually.

[For more details about the installation of USB driver, please refer to **【Basic Part 2.8 Install USB Driver】**](#)

3. For downloading through serial port, users should weld the cable by themselves.

[For more details about welding downloading cable for serial port, please refer to the manual of **【Communication Connection Guide】**](#)

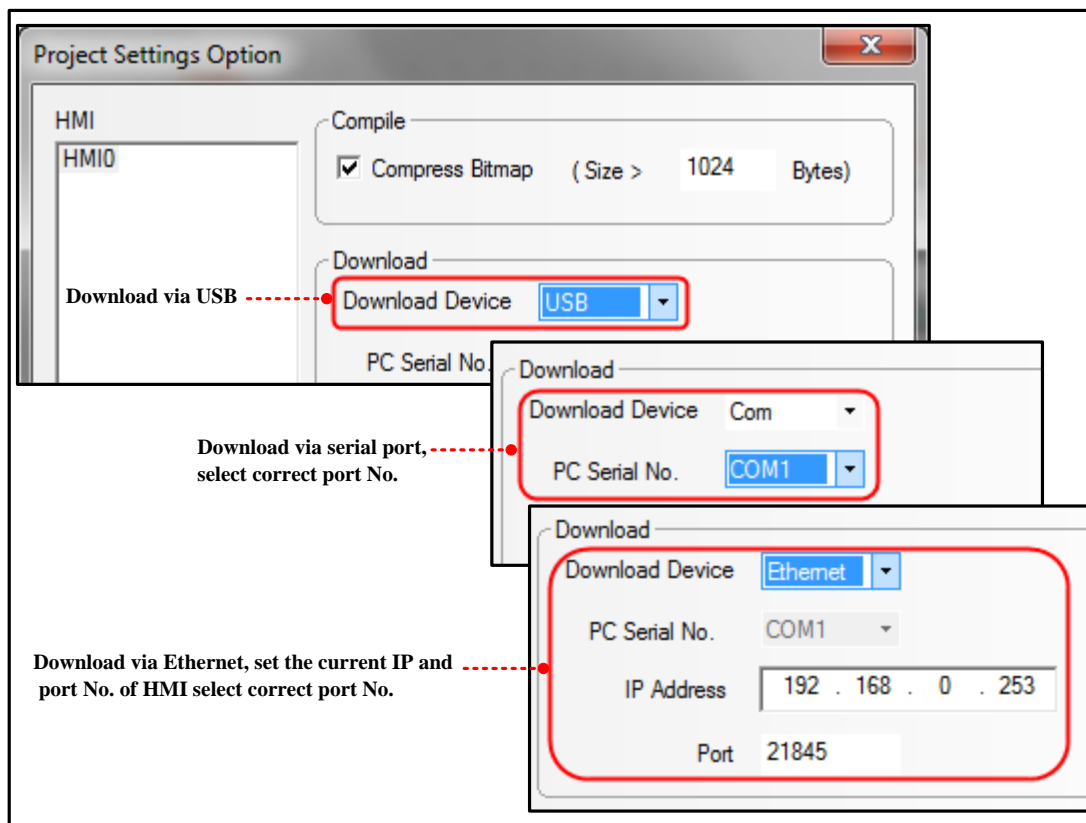

- Notes for downloading through Ethernet and setting of IP:
 - The IPs of PC and HMI should be in the same section. That means the first three digits should be the same and the last digit should be different. If the devices are connected in local area network, then the IPs should not conflict with other device in the local area network.
 - Modify the current IP and PORT of HMI

Click **【HMI Attribute】** — **【HMI】** , set the target IP to HMI, compile and download into HMI, then the IP of HMI is in line with the set value in project.

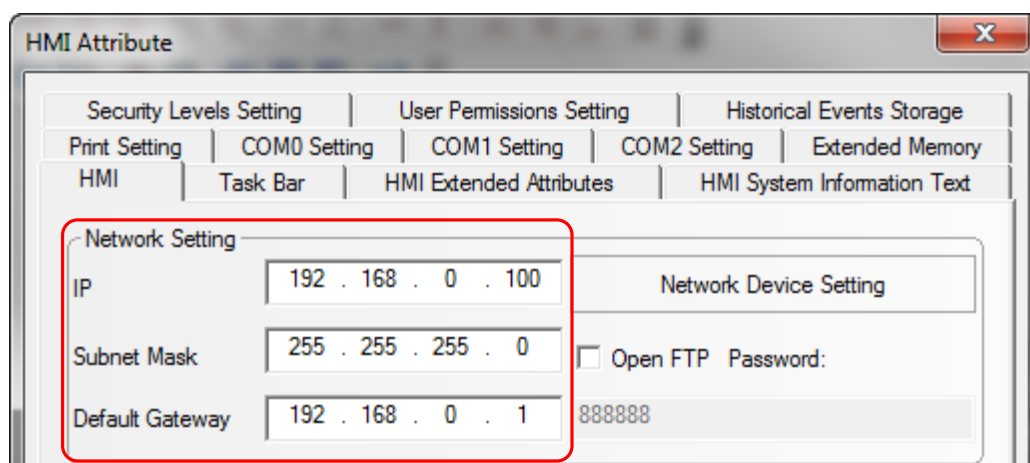

- Set IP in SETUP Interface

[For more details about setting IP in SETUP interface, please refer to 【Hardware Part 3 System Setting Mode】](#)

- Set IP via **【Update IP/PORT】** in KHManager

[For more details about setting IP via **【Update IP/PORT】** in KHManager, please refer to **【Advanced Part 8 KHManager】**](#)

7.3.2 Download via U disk or SD card

[For more details about downloading via U disk or SD card, please refer to **【Hardware Part 3 System Setting Mode】**](#)

7.3.3 Download Selection

In the property box of **【KHDownload】**, select the related options in **【Select Section】** to download the files needed.

Detailed description for **【Select Section】**

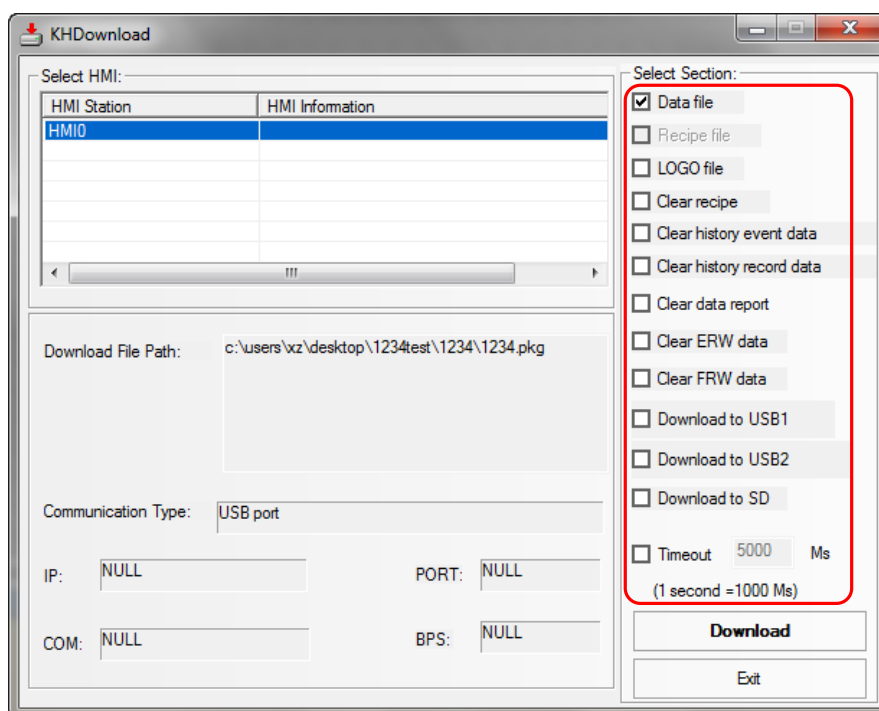

Name	Description
Data file	Download user project files in .pkg format
Recipe file	Download recipe files in .rcp format
LOGO file	Download Initial Start Window in .logo format
Clear recipe	Clear recipe data saved in RB/RBI/RW/RWI
Clear history event data	Clear the record in 【Event Display】 / 【Historical Event Display】 parts
Clear history record data	Clear the record in 【Historical Event Display】 / 【Trend Curve】 / 【Trend Curve】 parts
Clear data report	Clear data saved in 【Data Report】 parts
Clear ERW data	Clear the data saved in external register ERW/ERWI
Clear FRW data	Clear the data saved in FLASH register FRB/FRBI/FRW/FRWI
Download to USB1	Download the project files to external register USB1
Download to USB2	Download the project files to external register USB2

Download to SD	Download the project files to external register SD
Timeout	Set the timeout time of download, the unit is millisecond, and it ranges from 0 to 65535

- Download recipe files

Recipe files should be imported before downloading. Single click  icon in toolbar or single click **【Options】** menu — **【Import Recipe】**, then dialog box of **【Open】** pops up, select the recipe files to be downloaded and single click **【Open】** to load the recipe files:

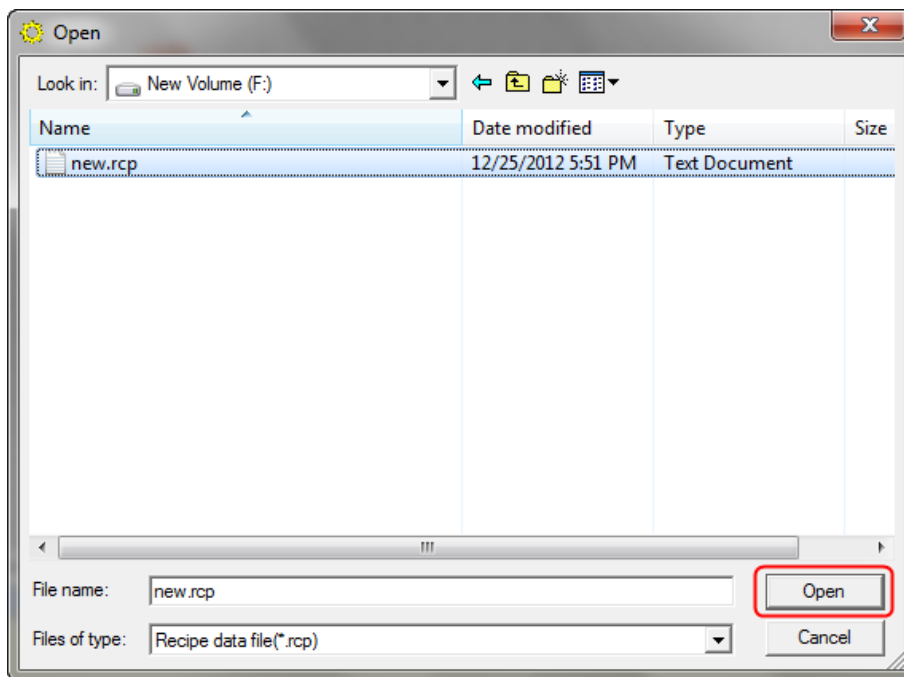

Compile and then download, select **【Recipe File】** as shown in the below figure:

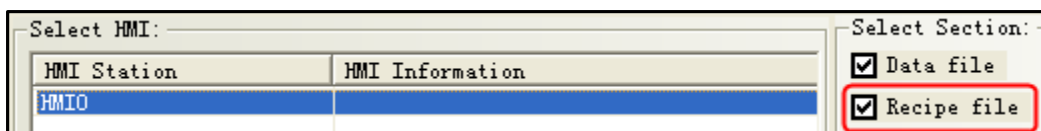

Kinco HMIware will record the directories of recipe files, when the selected recipe files is loaded into HMIKinco HMIware. If the directories of recipe files changed, warning information will appear in the compilation message window, the recipe files will no longer be selected when download again.

```

Message window
WindowFrame0
WindowCommon Window
WindowFast Selection
WindowNUM Keyboard
WindowASCII Keyboard
WindowConfirm Action Window
WindowHEX Keyboard
Word Library
Graphics Library
Pre-compile HMI0:macro_0.c
Generate (Franklin Gothic Medium Italic)font file:font_1.ttf
Macrocode...
Connecting...
Warning : Link Recipe file: C:\Documents and Settings\SALES0019\My Documents\1219.rcp failed!
Compilation Done! Warning 1 Error 0!
    
```

- Download LOGO file (Initial Start Window)

[For more details about \[LOGO file\], please refer to \[Advanced Part 2.8 LOGO Screen \(LOGO\)\]](#)

- Clear data when download

When download project, user could select **[Clear recipe]**, **[Clear history event]**, **[Clear history record]**, **[Clear data report]**, **[Clear ERW data]**, **[Clear FRW data]**. Select the data to be deleted, then the related data in HMI will be deleted when downloading.

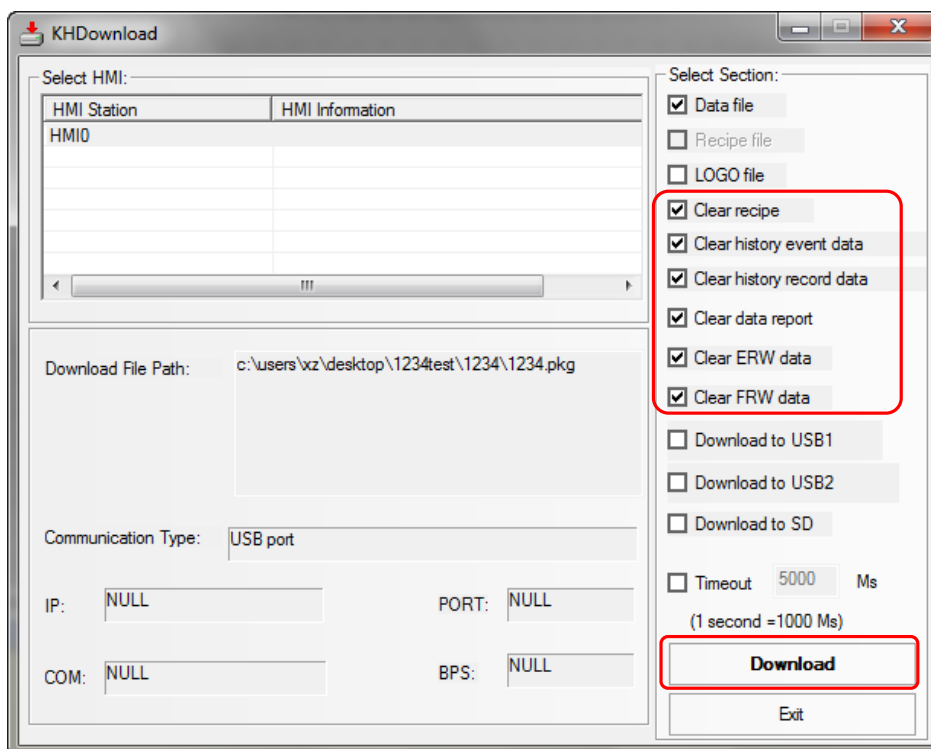

- Project runs directly in external storage devices

When there are too many pictures in project, then the project will be too big to download into HMI. Prompt: When compress bitmap of large size, users could download the project to external devices.

Select **[Download to USB1]**, **[Download to USB2]**, **[Download to USB3]** when download as shown in the below picture:

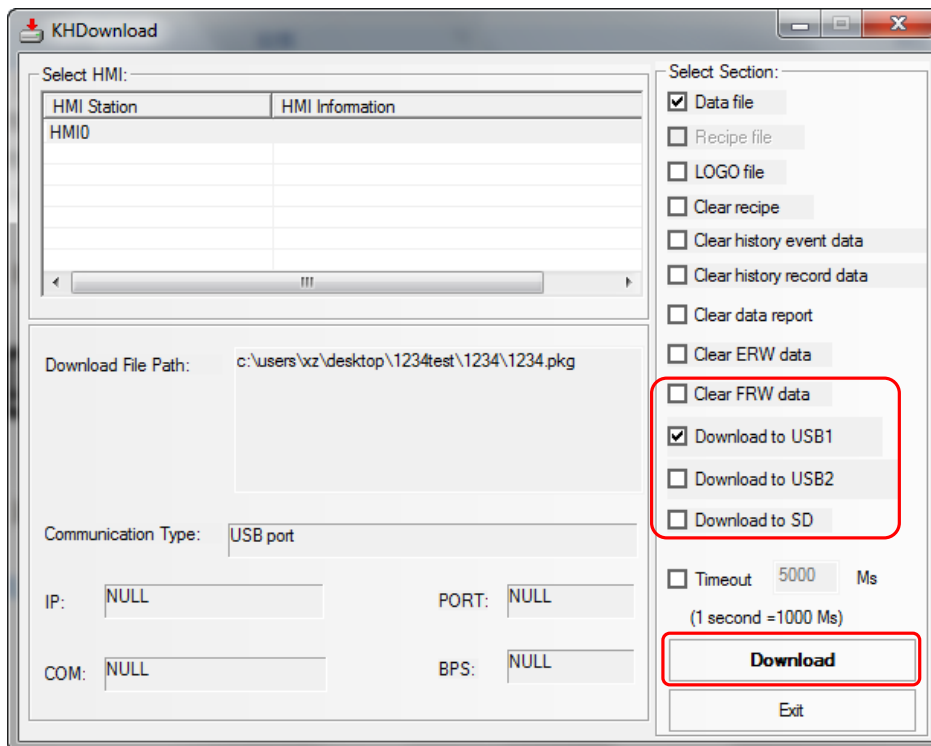

Single click **Download**, the project will be downloaded to external memory device.



1. The function that project runs directly in the external storage device is only applicable for HMIs supporting external storage devices.
2. The projects copied directly into external storage devices cannot run.
3. The external storage devices cannot be removed during running, otherwise, the project stored in external device will be abnormal.

- The timeout time of KHDDownload can be set by user

If the timeout option is checked, user can set the timeout time of download, the unit is millisecond, and it ranges from 0 to 65535. The function can improve download timeout error of serial port, USB and Ethernet port.

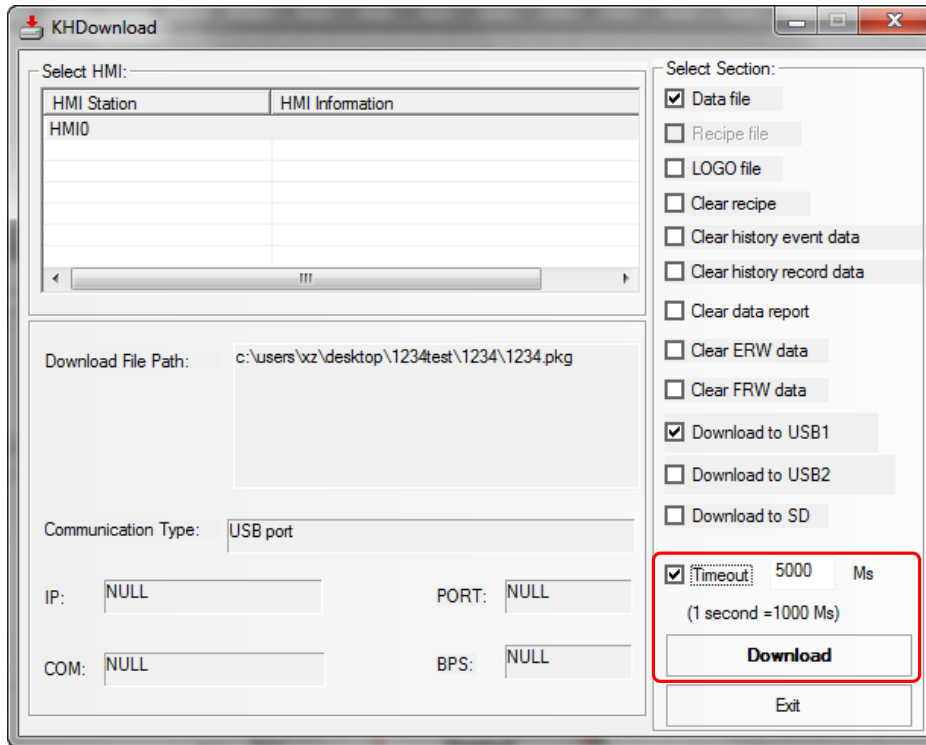

7.4 Upload/ Download/Compile Project via KHManager

[For more details about upload, download, compile project, please refer to 【Advanced Part 8 KHManager】](#)

8 KHManager

8.1 Introduction to KHManager

KHManager consists of six processing modules: **【Download】** , **【Upload】** , **【System Operation】** , **【Get Version】** , **【Decompile Operate】** , **【Pass Through Communication】** .

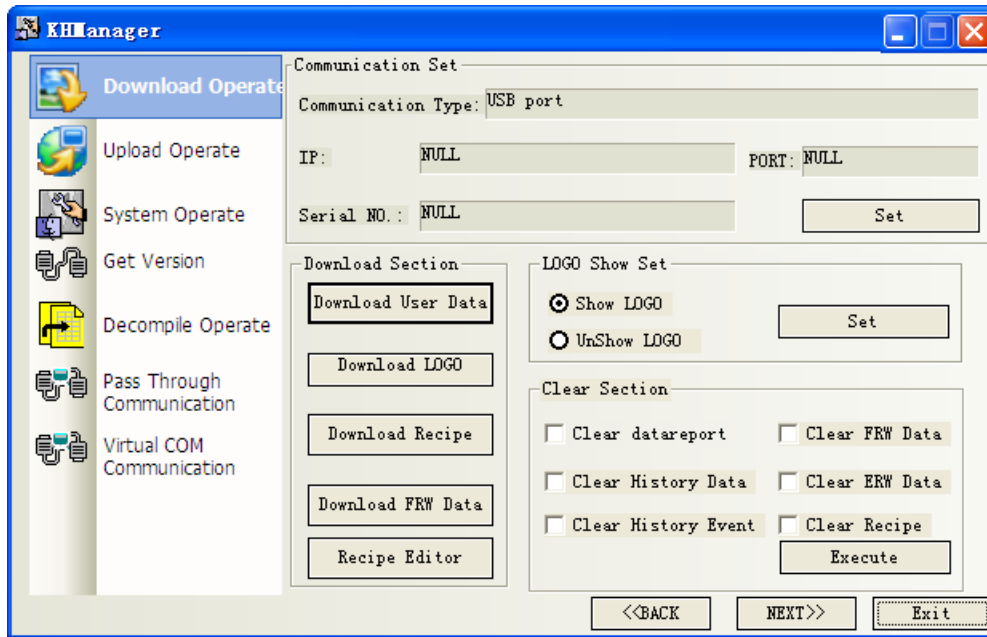

【Communication parameter setting】: The current download way selected in KHManager will be displayed. Click **【Set】** to modify the current download way.

Download way	Parameter setting
Download via USB port <input checked="" type="radio"/> USB Port	No need to set communication parameters
Download via serial port <input checked="" type="radio"/> Serial Port	Choose the current used serial port NO.
Download via network <input checked="" type="radio"/> Network	Set the IP address and port number of the current HMI

Communication Set	
IP:	192 . 168 . 100 . 249
PORT:	21845
Serial NO.:	COM1

【PageUP】 / 【PageDown】: Click **【PageUP/PageDown】** to skip among the 6 processing modules.

【Exit】: Exit KHManager.



【Pass Through Communication】 is not supported temporarily

8.2 Methods of Open KHManager

- Open from the **【Start】** menu of PC.
- Double click the shortcut of KHManager on desktop.
- Open from **【Tools】** menu of Kinco HMIware software.

Click **【Tools】** menu— **【System Manager】 / 【HMI Version Manager】 / 【Upload Manager】 / 【Upload Init Window】 / 【Download Init Window】 / 【Upload project】 / 【Decompile Manager】** to open **【KHManager】**

- Double click **【KHManager.exe】** in the installation directory of Kinco HMIware software.

8.3 Download

Detailed descriptions of 【Download】		
Download Section	Download User Data	Download .pkg files to HMI
	Download LOGO	Download Initial Start Window of .logo files to HMI
	Download Recipe	Download .rcp files to HMI
	Recipe Editor	Open 【Recipe Editor】
	Download FRW Data	Download .frp files to HMI
Initial Start Window setting Area	Show LOGO	Select 【Show LOGO】 , click 【Set】 , HMI will display Initial Start Window when boots up.
	UnShow LOGO	Select 【UnShow LOGO】 , and click 【Set】 , HMI will do not display Initial Start Window when boots up, but keeps white screen until project window displays.
Clear Section	Clear Recipe	Select 【Clear Recipe】 , and click 【Execute】 , to clear the data that is saved in physical storage area of HMI RB/RBI/RW/RWI.
	Clear FRW Data	To clear the data that is saved in physical storage area of FLASH FRB/FRBI/FRW/FRWI.
	Clear ERW Data	To clear the data that is saved in physical storage area of external memory

		ERW/ERWI.
	Clear History Data	To clear the displayed history data that is recorded in 【History Data Display】 / 【Trend Curve】 / 【XY Curve】 parts, at the same time the history data and files that are saved in recipe memories and external memories will also be cleared.
	Clear History Event	To clear the displayed history events that are recorded in 【Event Display】 / 【Historical Event Display】 , at the same time the history data and files that are saved in recipe memories and external memories will also be cleared.

8.4 Upload

Detailed descriptions of 【Upload】			
Upload User Data	Upload project files of .pkg format	Recipe Editor	Open 【Recipe Editor】
Upload Recipe	Upload .rcp files in HMI	Upload FRW	Upload .frw files in HMI
Upload LOGO	Upload .logo files in HMI		

8.5 System Operation

Detailed descriptions of 【System Operation】		
Get HMI IP / PORT Information Area	Obtain the IP address and port number information of the target HMI	
Update IP/PORT Area	Update the IP address and port number to the set value	
Jumping Section Area	Return to User Application Status	HMI jumps to run the configuration program
	Return to Set Application Status	HMI changes to the embedded SETUP interface
Update Operation Area	Update the kernel/ file system	Update firmware of HMI For more details please refer to [Hardware Part 5 Firmware Update Mode]

8.6 Get Version

User could view firmware version information of HMI through **【Get Version】** in KHManager, click **【Version Get】** , HMI firmware version information will be displayed. Otherwise please check whether the current communication mode is correct or other reasons.

8.7 Decompile Operation

The configuration screen edited by Kinco HMIware is saved as wpj files. Compile to generate pkg files which are required for running in HMI and download into HMI. So the files uploaded from HMI are in pkg format. Before open the projects uploaded from HMI, users should decompile the pkg files by KHManager to generate a project file in which wpj file and other files are included, then users can open wpj file and edit.

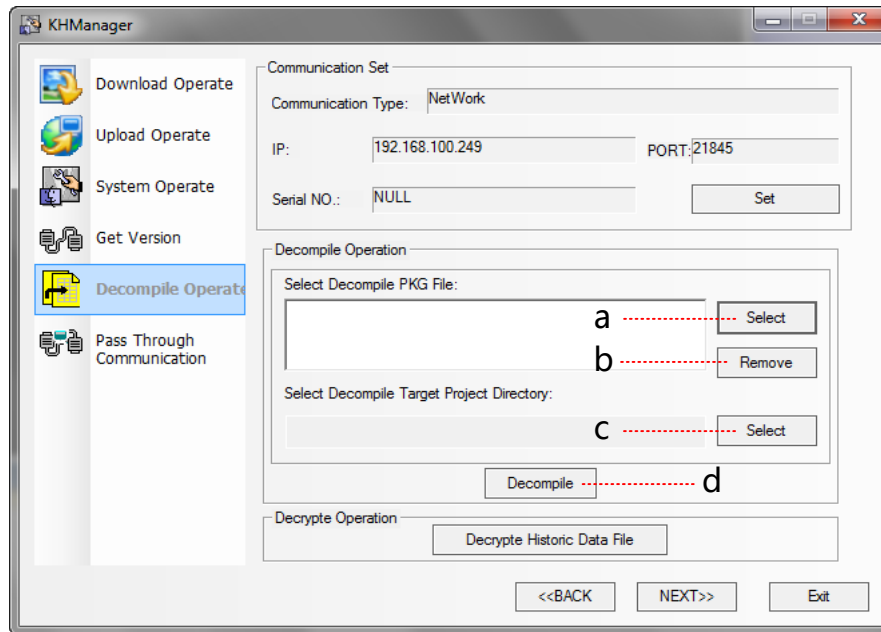

- a. Select the target pkg files to be decompiled
- b. Delete the redundant pkg files no need to be compiled.
- c. Select a saving path for the decompiling project files.
- d. Execute decompilation operation

Regardless of whether the file allow decompiling or not, upload password dialog box will pop up and request for decompilation password. If decompilation is prohibited, user cannot move to the next step. While if decompilation is allowed and no password is set, and then enter the default password 888888 to move to the next step.



1. When there are more than one (2 or more) HMIs in a project, users need to add all the pkg files of each HMI to execute decompilation operation.
2. When there are more than one (2 or more) HMIs in a project, all the pkg files uploaded from the HMIs must be compiled at the same time, otherwise, the the pkg files cannot be decompiled.

8.8 Data Decryption

To decrypt the encrypted CSV files.

[For more details about \[Data Encryption\], please refer to \[Advanced Part 2.15 Data Encryption\]](#)

9 Macro

Macro uses C language to release logic and arithmetic calculation. User can use macro and other components together to release some complex calculation and make HMI strong function. The macro instructions in Kinco HMIware are compatible with standard C language (ANSI C89) .

9.1 Macro Editing Environment

There are three parts in this edit environment, they are macro edit window, Macro variables window and macro file list in the project files window.

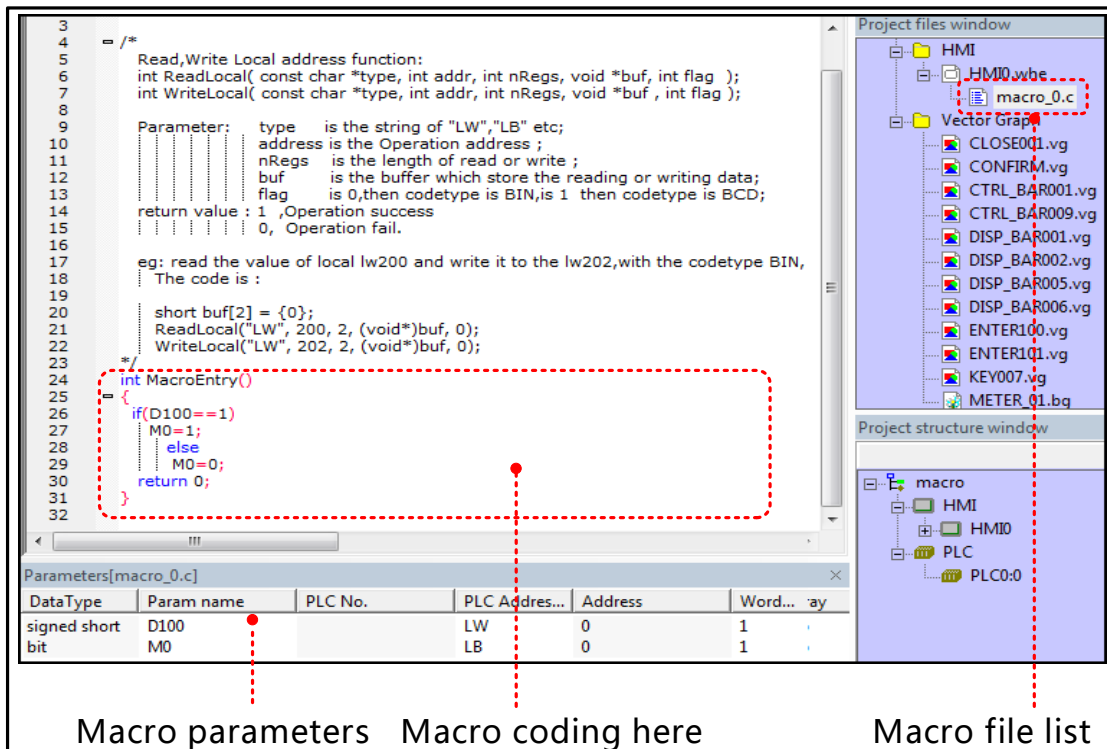

The detail description of macro edit environment

detail description of macro edit environment	
Macro edit window	User writes C language code in this window, the variables are defined in the Parameters list; you can use them in the C code.
Macro variables window	The write and read variables in this macro, which are external variable of this macro.
Macro file list	User can rename and delete macro in this list. If there are multiple macro, user also can switch macro among different macro.

9.2 Macro Edit

9.2.1 Build Macro

There are two ways to build macro:

- Click on the icon 

- Click on the “Option”>>Macrocode...(M)

There is a New Macrocode dialog window when you build the macro:



1. Choose the HMI where the macro is build, for example HMIO.
2. There is a default macro name(macro_0.C) in the File Name, user can rename it .
2. Click on OK to enter the macro edit window.

9.2.2 Delete Macro

Right click the macro in the Project files window; choose the delete to delat the macro. As shown in the following picture:

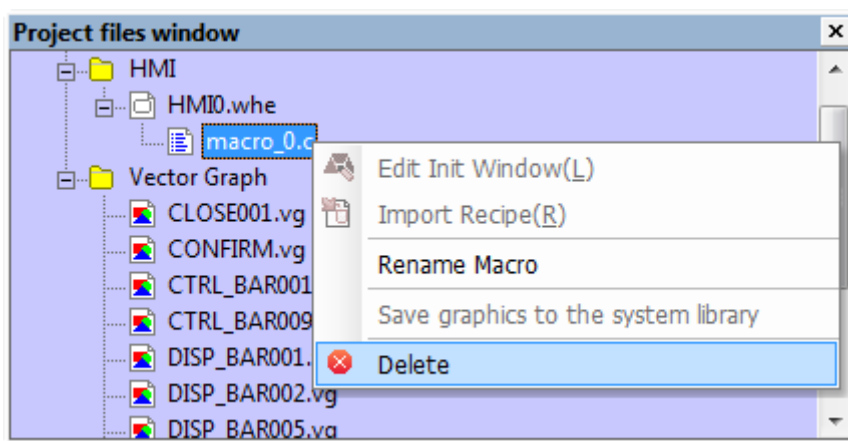

Note that the delete operation of macro does not support undo operation,

9.2.3 Rename Macro

Right click the macro in the Project files window; choose the Rename Macro to rename the macro. As shown in the following picture:

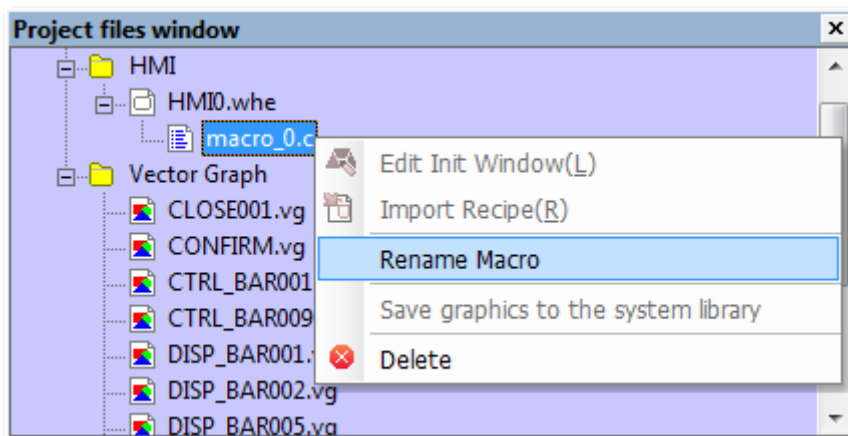

9.2.4 Program Macro

1 Define the macro variables before program the macro.

Macro Variables

In macro, the unit whose value can be changed is called variable, each variable has a name and a initial value, it takes a memory unit in the memory.

Variable name

When user builds a new variable, the default name is Param and user can modify the name. The definition of macro name must follow the principle of C language, the following are exceptional case:

1. Cannot use the reserved word of language C code.
2. The variable name is not case sensitive(not C language standard)
3. The variable name must start with 26 English letters
4. The variable name only supports 26 English letters, number and underline.
5. The number of group data must be from 2 to 1024, but the number of (unsigned) shot group data cannot be 4, the number of int/float group data be 2.(not C language standard)

The type of macro variable

There are internal variables and external variables in the macro variables

Internal variables: they are the registers in HMI. The internal variables can be defined in the Parameters window; it also can be defined in the macro edit window directly.

External variables: they are the registers in the PLC/controller which is connected to HMI. The external variables must be defined in the parameters window, and then they can used in the macro edit window.

The data type which is supported in macro variable

Data Type	Data Length	Description
Bit	1bit	Bit variable, 0 and 1

Signed short	1word (16bits)	Signed short integer variable, $-2^{15} \sim (2^{15} - 1)$
Unsigned short	1word (16bits)	Unsigned short integer variable, $0 \sim (2^{16} - 1)$
Signed int	2word (32bits)	Signed integer variable, $-2^{31} \sim (2^{31} - 1)$
Unsigned int	2word (32bits)	Unsigned integer variable, $0 \sim (2^{32} - 1)$
Float	2word (32bits)	Single float variable
Double	4word (64bits)	Double float variable

The write & read type of macro variable

write & read	Description
Read	Read the register before the C code is executed, the register will not be read when the C code is running.
Write	Write the register after the C code is executed, the register will not be write when the C
Read/Write	Read the register before the C code is executed and write it after the C code is executed.



Usually, we define the registers which only need reading as Read type; the registers which need writing have read operation too, so we define them as Read/Write. Regarding some special registers, which are write only, but cannot be read, we can define them as Read. Therefore, in the assignment instruction, the variables at the left side of “=” icon are usually defined as Read/Write and variables at the right side of “=” icon are usually defined as Read

Operation of macro variable

Right click variable list in the macro variable window, user can choose the add/delete/modify/export/import macro operations.

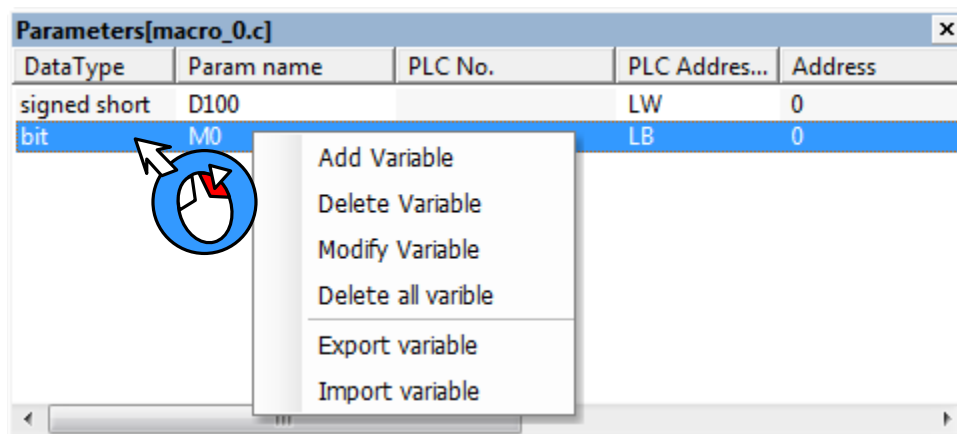

Detail descriptions of variable operations

Detail descriptions of variable operations	
Add Variable	Add the new variable to the macro
Delete Variable	Delete the selected macro
Modify Variable	Modify the attributes of selected macro

Export Variable	Export the defined variables to PC in a CSV file.
Import Variable	Import the variable CSV file to the macro variable window.

The notes of macro variable

- (1) When defining the variable, make sure that there is no overlap in the address range, for example, the LW1000 is defined as a float variable A (double words), that is A takes two addresses: LW1000 and LW1001. If user defines another variable which uses LW1001, there will be error in the macro calculation.
- (2) The macro only supports the logic and arithmetic operation, but do not supports char type operation.
- (3) When the variable uses variable station number, especially when the special registers are used as index, the value in the index registers must be modified before macro execution, so the modified station number can be effective in the macro. If the index value is set in the macro, the modified station number can be effective in the next execution of macro.
- (4) The Export/Import operation only supports export/import all the variables, but not supports export/import a single variable.
- (5) When user uses Excel to edit exported variable CSV file, note that the ParamName~StationNumID are default formwork, do not modify them or there will be error when you import the CSV file to the macro variable window.

Program the C code in the Macro Edit Window

```

1  #include "macrotypedef.h"
2  #include "math.h"
3
4  /*
5  Read,Write Local address function:
6  int ReadLocal( const char *type, int addr, int nRegs, void *buf, int flag );
7  int WriteLocal( const char *type, int addr, int nRegs, void *buf , int flag );
8
9  Parameter:  type   is the string of "LW","LB" etc;
10             address is the Operation address ;
11             nRegs   is the length of read or write ;
12             buf     is the buffer which store the reading or writing data;
13             flag    is 0,then codetype is BIN,is 1 then codetype is BCD;
14 return value : 1 ,Operation success
15                0, Operation fail.
16
17 eg: read the value of local lw200 and write it to the lw202,with the codetype BIN,
18 The code is :
19
20     short buf[2] = {0};
21     ReadLocal("LW", 200, 2, (void*)buf, 0);
22     WriteLocal("LW", 202, 2, (void*)buf, 0);
23 */
24 int MacroEntry()
25 {
26
27     return 0;
28 }
29
30
31

```

```

24 int MacroEntry()
25 {
26     if (D100==1)
27         M0=1;
28         else
29             M0=0;
30     return 0;
31 }

```

Macro coding here



1. Add the note information in the macro, so you can check and modify the code conveniently in the future.
2. Use the tab and line break to make the macro a good structure.
3. Do not delete or modify the default code in the macro edit window, press the Enter before “return” to add your code.

3. After the macro is build, save and compile the HMI program , then check if there is any error information in the Message Window

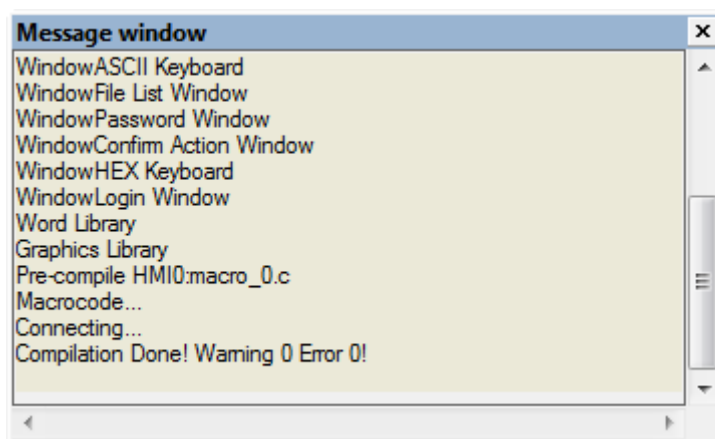

9.2.5 Execute Macro

There are 6 methods to execute the macro in Kinco HMIware, user can choose one method according his application.

1. Triggered when the HMI system starts.

Set initialization macro in HMI Attributes>>HMI Extended Attributes, this macro will be trigged when the HMI starts, user can use this macro to set the initialization value of some parameters and transmit some recipe value.

2. Triggered by Function Key

Use the Execute Macro function in the Function Key, when the function is pressed , the macro will be triggered once

3. Triggered by Timer

There are many trigger method in the Timer, it is very flexible to trigger macro by timer.

4. Triggered by PLC Control

When the certain register satisfies the setting condition, the macro will be triggered.

5. Triggered by Event

The macro is triggered when the event is triggered

6. Triggered by Notification

User can use notification in Control Setting to trigger macro.

9.3 Macro Application

For example, we use the value of D100 (PLC register) to change the state of M0 (PLC register), we make this in a macro as an example: when the value of D100 is 123, M0 is 1, or the M0 is 0.

First, build a macro, set the macro name “ouput status.c”

Then define the variable D100 and M0 in the Parameters Window in macro.

Parameters[macro_0.c]								
Data Type	Param name	PLC No.	PLC Address type	Address	WordNum	OptMode	Array	Array Length
signed short	D100	0	D	100	1	Read/Write	No	
bit	M0	0	M	0	1	Read/Write	No	

Write the following macro code in the macro edit window.

```

24 int MacroEntry()
25 {
26     if (D100==123)
27         M0=1;
28         else
29             M0=0;
30     return 0;
31 }
    
```

Save the project, close the macro edit window then switch to the HMI program edit screen, make the program as follows:

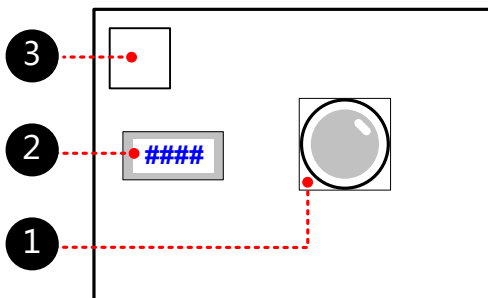

❶ Bit State Lamp, which is used to display the state of M0. Its attribute are as follows:

Read Address	M0 (PLC register)
Graphics	State 0 State 1 Use Vector Graphics,

❷ Number Input Component, which is used to input the value of D100, its attributes are as follows:

Read/Write Address	D100 (PLC Registers)
Graphics	State 0 User Vector Graphics,

Timer Component, which is used to execute the macro, its attributes are as follows:

Execution Cycle	1×100ms
Execute Macro	Output status

Save, Compile and Execute:

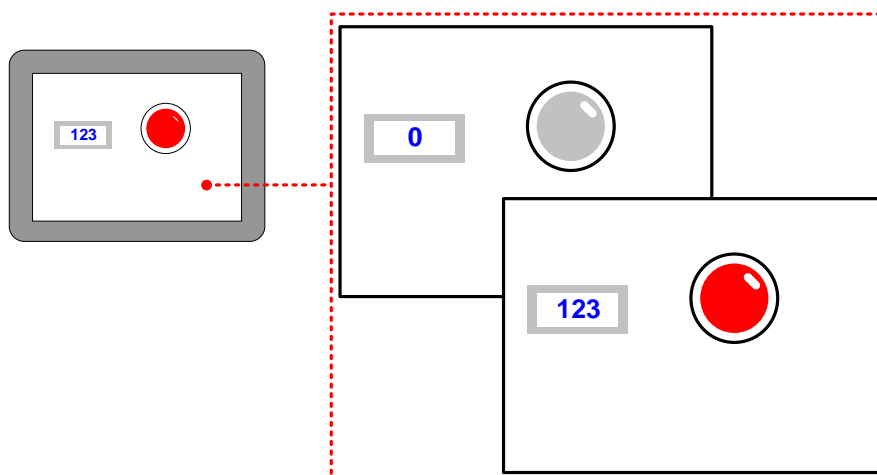

9.4 Local Variable Function

When you use the internal (local) variable, you do not need to define the variable in the macro parameters window, you can define it macro directly, that is to use the local variable of HMI.

The advantage of using local variable is that the local variable in the macro can be read/write in real time and the execution speed is faster, performance is better. At the same time, it also saves the time of defining variables in the macro parameters window.

In the macro edit window ,there is demo code(example) to read/write the local variable, user can write the macro code to read/write local variable according the demo code, see as follows

```

/*
Read,Write Local address function:
int ReadLocal( const char *type, int addr, int nRegs, void *buf, int flag );
int WriteLocal( const char *type, int addr, int nRegs, void *buf , int flag );

Parameter: type   is the string of "LW","LB" etc;
            address is the Operation address ;
            nRegs  is the length of read or write ;
            buf    is the buffer which store the reading or writing data;
            flag   is 0,then codetype is BIN,is 1 then codetype is BCD;
return value : 1, Operation success
              0, Operation fail.
eg: read the value of local lw200 and write it to the lw202,with the codetype BIN,
The code is :
    short buf[2] = {0};
    ReadLocal("LW", 200, 2, (void*)buf, 0);
    WriteLocal("LW", 202, 2, (void*)buf, 0);
*/

```

In this demo code, we transfer the values in LW200 and LW201 to the LW202 and LW203.

We will explain to you how to use the local variable function in the following example.

For example, use the macro to achieve the addition calculation: LW100(HMI local register) adds LW101(HMI local register) and transfer this result to LW102(HMI local register), the macro code is as follows :

```

24 int MacroEntry()
25 {
26 short buf[2]={0};
27 ReadLocal( "LW" ,100,2,(void*)buf,0);
28 buf[0]=buf[0]+buf[1];
29 WriteLocal( "LW" ,102,1,(void*)buf,0);
30 return 0;
31 }
    
```

In this example ,

ReadLocal ("LW", 100, 2, (void*)buf, 0) means read the value in LW100 and LW101 and give this value to buf[0] and buf[1].

buf[0]=buf[0]+buf[1] means addition calculation

WriteLocal ("LW", 102, 1, (void*)buf, 0) means write the calculation result to the LW102.

Save, Compile and Execute:

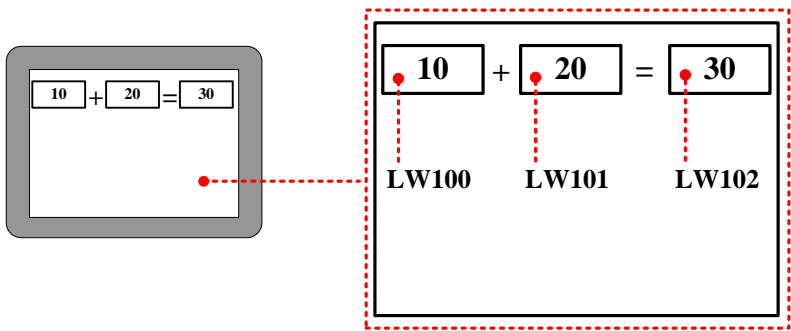

9.5 Array Application

Array is a group of variables, who has the same data type and name. These variables are called element of array. Each element has its own serial number in the array, this number is called index. User can distinguish these elements by their index. The total number of the element of an array is also called the array length.

We explain the array to you in the following example:

For example, use macro to assign values to 100 continuous registers which starts from D100(PLC register), if we do not use array , we need to define 100 registers in macro parameters window and assign value one by one in the macro code. See as follows:

signed short	data_0	0	D	100	1
signed short	data_1	0	D	101	1
signed short	data_2	0	D	102	1
	
signed short	data_99	0	D	199	1

Macro code:

```

24   int MacroEntry()
25   {
26   data_0=120;
27   data_1=135;
28   data_2=200;
...
...
125  data_99=210;
126  return 0;
127  }
128

```

In the above macro code, the variable name has no unified rule, at the same time, it also takes too much time on define the variables. If users use the array, they can define these variables in one array, see as follows:

Parameters[macro_0.c]									
Data Type	Param name	PLC No.	PLC Address type	Address	WordNum	OptMode	Array	Array Length	
signed short	data	0	D	100	1	Read/Write	Yes	100	

Macro code:

```

24   int MacroEntry()
25   {
26   data[0]=120;
27   data[1]=135;
28   data[2]=200;
...
...
125  data[99]=210;
126  return 0;
127  }
128

```

User can use a name and index to representation a variable in the array. For example, data [0] means the first variable in a array, data[1] means the second variable in a array. The data is the variable name of this array, the number after data is the index of this array, we need to put the index to a [].

For example, the following example is to define a array variable, then use loop statement to assign 10~15 to the array elements, these data will be displayed on the Number Display Components. The variable is defined as follows:

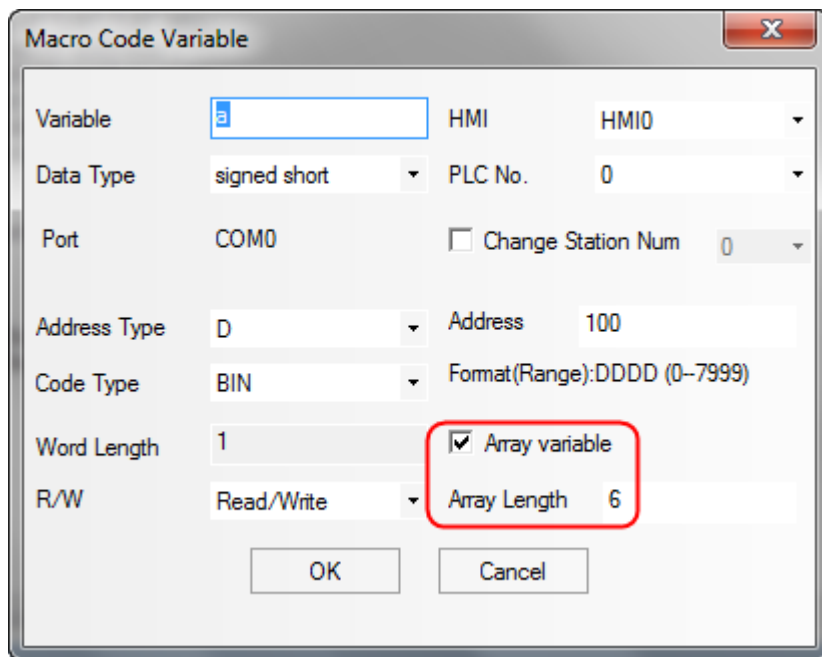

Parameters[macro_0.c]								
Data Type	Param name	PLC No.	PLC Address type	Address	WordNum	OptMode	Array	Array Length
signed short	a	0	D	100	1	Read/Write	Yes	6

Macro code:

```

24  int MacroEntry()
25  {
26  int i;
27  for(i=0;i<6;i++)
28  a[i]=i+10;
29  return 0;
30  }
31
    
```

Save , compile and execute:

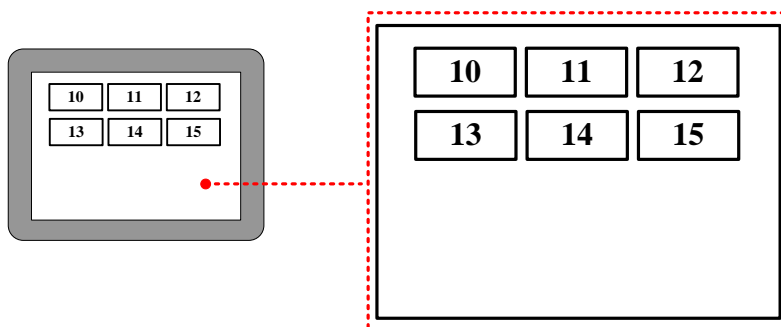

Actually, array is a list of data which has the same data type in the memory. Take the above array for example; a[i] starts from the number 100 in the memory. The content and value of this array are as follows:

Variable	a[0]	a[1]	a[2]	a[3]	a[4]	a[5]
Value	10	11	12	13	14	15

Memory Unit	D100	D101	D102	D103	D104	D105
-------------	------	------	------	------	------	------

-
1. When users visits or assign array variable, they need to according to the defined data type.
 2. The indexes of array are inter, which starts from 0, not 1. The index n means the (n+1) variable
 3. The array a[n] has n elements, but there is no a[n] in these elements. If user uses the nonexistent elements in macro, there will be a overflow error.
-

9.6 Some Notes on the Macro

- The values of external variables in the macro are read once when the macro is triggered. The macro will not read it again or in real time in the macro execution process. So the macro result will not be changed if the registers are changed from outside during the macro execution process. When we use the macro, we need to make sure that all the input value are ready before we trigger the macro, or we may cannot get the expect result.
- The macro result is output once when the macro is finished. The external variable value will not be changed during the macro execution process. When we use the macro, we need to make sure that the macro is finished and all the outputs are updated, then we can get the right result..
- It is meanness to write the Read Only variable and it is meanness to read the Write Only variable. If the variable needs to be read and write, please define it as R/W. Besides, user must assign value to the variable which has write operation attributes(Write Only or R/W variable)
- User can define the temporary variable in the macro according to the C language, but can not set the global variable and static variable. If the global variable is needed, please use the LW, LB register.
- One macro can not call other macros in Kinco HMIware, if user wants to use the Function Call as the C language, they can use a trigger bit in one macro to trigger other macros.

10 Password

Kinco HMIware provides powerful password function for users, to ensure the security of user' s intellectual property.

The passwords are used for project protection, window protection, and important component protection.

- Project protection functions:
 - Password protection for opening project
 - Password protection for uploading project from HMI
 - Prohibit uploading project from HMI
 - Password protection for decompiling project
 - Prohibit decompiling project
- Operation window protection: To protect important windows, passwords must be entered when accessing important windows.
- Component protection: To avoid disoperation, user name and password must be entered to access some important components.



1. When project password, uploading password and decompilation password are used, please keep the passwords in mind. The manufacture does not provide factory recovery and universal password service.
2. The system default passwords for decompiling and uploading are 888888.
3. When the password is 0 or Null, system will automatically default to not using password. When passwords begin with 0, 0 is invalid.

Differences between User level and User permission :

Difference	Security Level	User Permission
Level Range	16 levels(0~15), level 0 is invalid	32 users, 32 operation permissions, User 0 is valid
User Name	None	Available
Logout time	None	Available
Add/Delete levels or permissions in HMI	Not support	Support
Modify password in HMI	Support	Not support
Access Restriction	Users with low security level password cannot access high security levels; high security level is the "authority".	A user can possess multiple operation permissions, and different users can possess the same operation permission. There is no hierarchy of user

	Users with high level password can access low security level windows or components.	permissions, only user name and correct password are needed to execute corresponding operation.
System reserved register	The involved system reserved registers are different.	

10.1 Project Protection

10.1.1 Project Password Protection

To prevent unauthorized access and protect user' s intellectual property, passwords are required to open project file of .wpj.

- Set project password for first time

Open the software, single click **【File】** — **【Project Password】** , then attribute box of **【Project Password Setting】** will pop up, input the password and confirm it. The project password will take effect when open the project next time.

- Enter password to open project

Once project password is set, password entry box will pop up when opening the project again.

Enter correct password to open the project, otherwise, error prompt box will pop up.

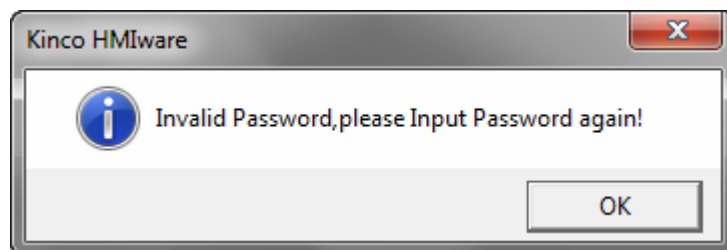

If entering password wrong continuously for 3 times, it would pop up a dialog box showing **【Invalid Password. Project cannot be opened!】**, then user needs to single click **【File】** menu— **【Open】** .

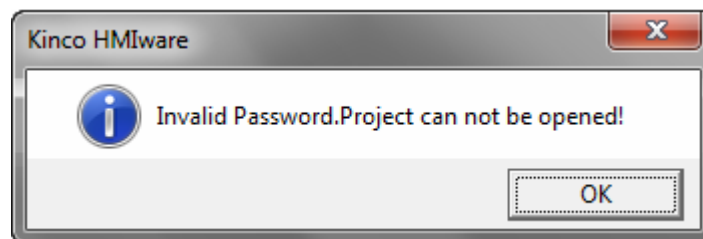

- Modify or cancel project encryption

Open the encrypted project, single click **【File】** menu— **【Project Password】** ,the attribute box of **【Setting Project Password】** will pop up. To modify password, users need to enter old password, and at the same time set new password. To cancel the password, users only need to enter the old password, leave the new password box blank. Single click **【OK】** button., then the modification will take effect when opening the project next time.

10.1.2 Upload Password Protection and Prohibit Uploading

- Upload Password setting

Project allows uploading by default, but upload password is required to prevent unauthorized operation. Default password is “888888” .

Upload Password setting: Check the option of **【Allow Upload】** in **【HMI Attributes】** — **【HMI Extended Attributes】** page. After upload password is set, dialog box of **【Password input】** will pop up when uploading, as shown in following pictures:

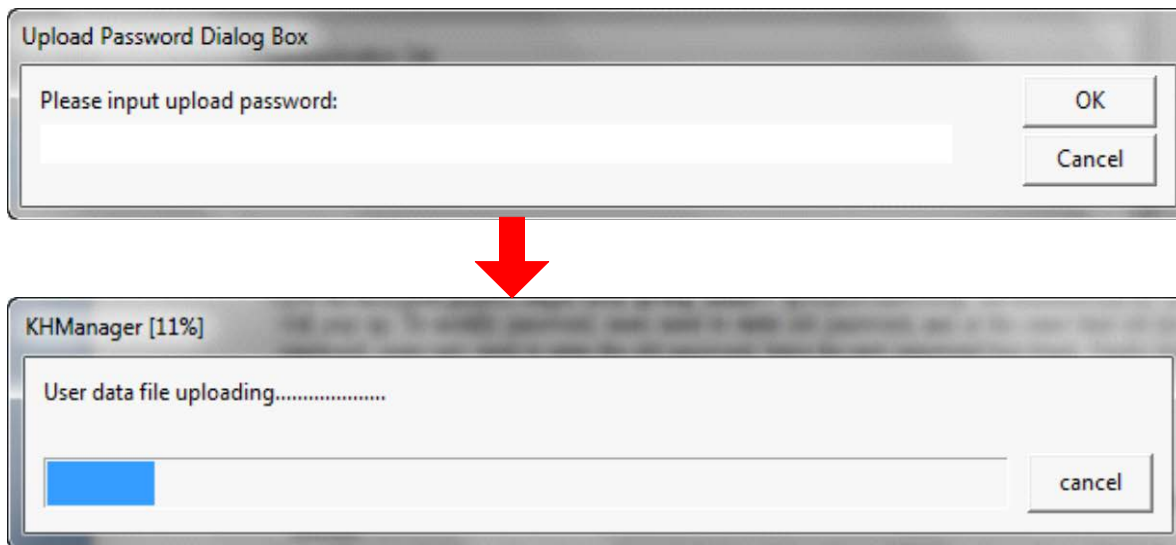

1. Upload password cannot be null.
2. Data package loss may occur during uploading, then restart the HMI and upload again.
3. Project allows uploading by default, but upload password is required to prevent unauthorized operation. Default password is "888888" .

- Prohibit uploading: prohibit uploading project from HMI. The specific setting is: **【HMI Attribute】** — **【HMI Extended Attributes】**, do not select the option of **【Allow Upload】** .

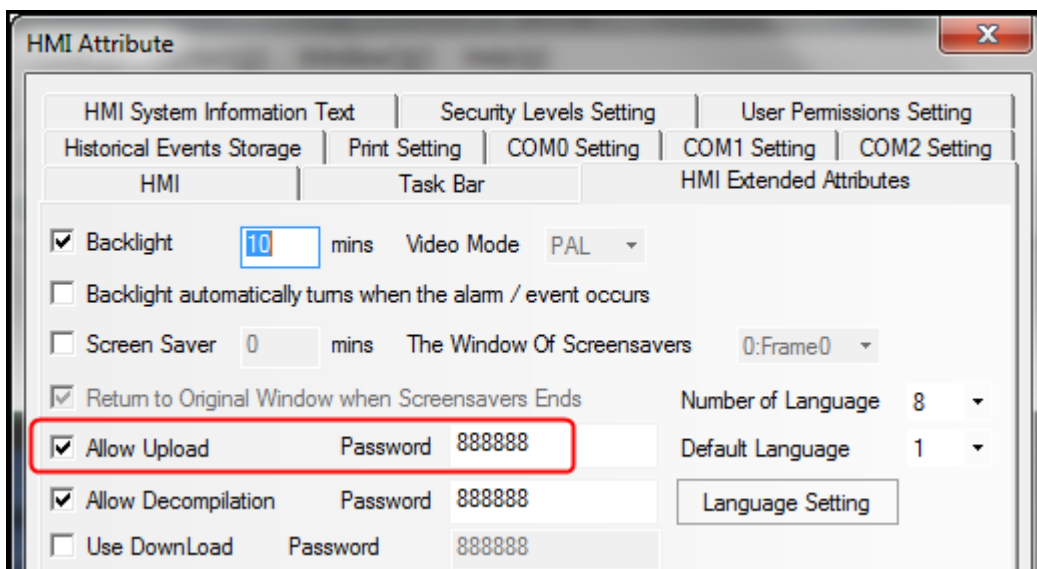

When prohibit uploading is set, prompt box will pop up if forcibly upload:

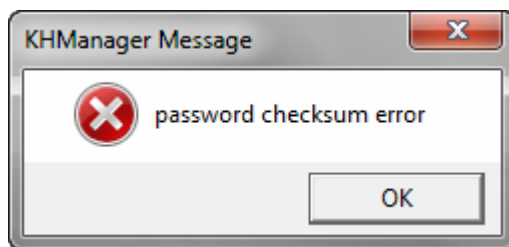

10.1.3 Decompilation Password Protection and Prohibit Decompiling

- Decompilation setting

Decompilation is used to convert the pkg files running in HMI to wpj files, which can be opened and edited by Kinco HMIware. For new project, system allows decompilation by default, and the default password is "888888".

Setting of decompilation: Select "Allow Decompile" in **【HMI Attribute】**—**【HMI Extended Attributes】**, and set password.

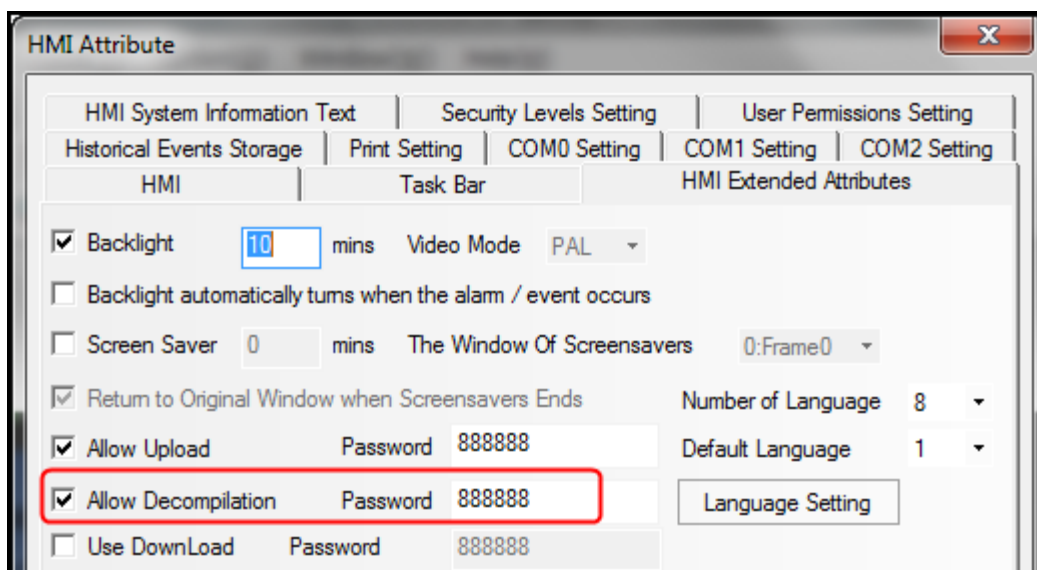

For projects that decompilation passwords have been set, when clicking decompilation, password entry box will pop up as shown in following picture:

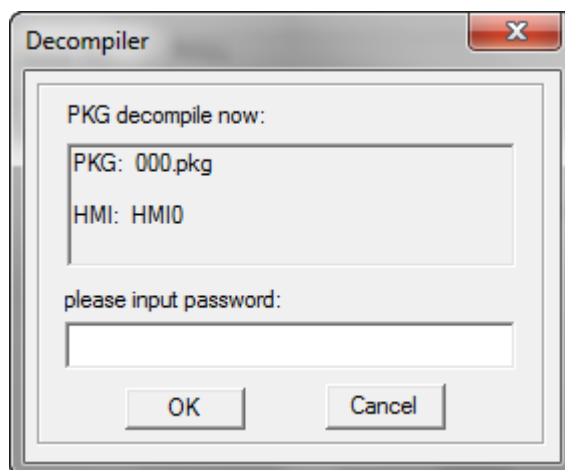

- Prohibit decompilation

Prohibit decompiling: Prohibit decompiling project from HMI. Do not check the option of **【Allow Upload】** in **【HMI Attribute】** — **【HMI Extended Attributes】** page, to prohibit user decompiling.pkg file to wpj.

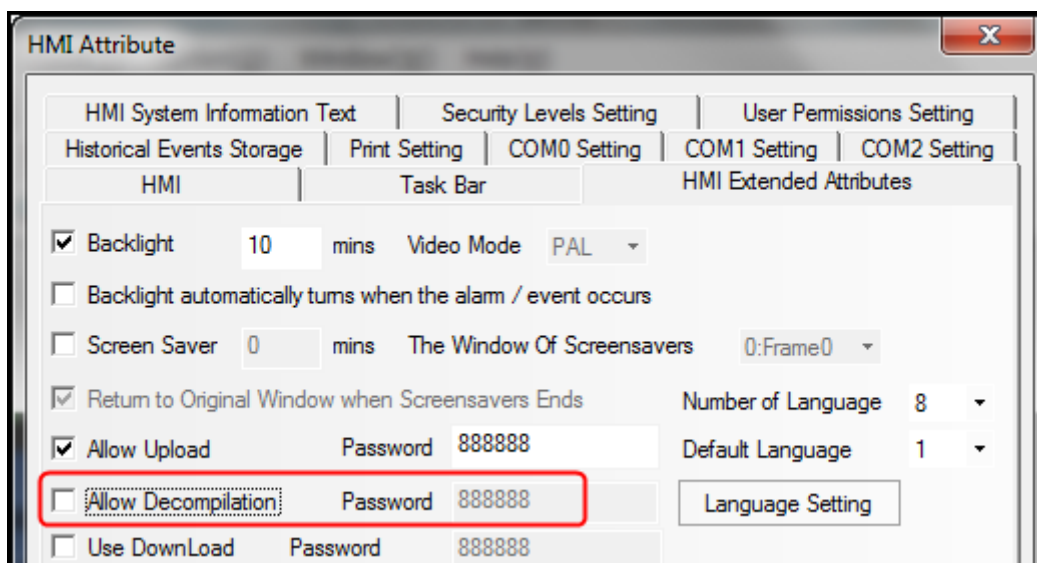

The pkg files that are set to prohibit decompiling can still be downloaded into HMI.

When prohibiting decompilation is set, prompt box will pop up if forcibly decompile:

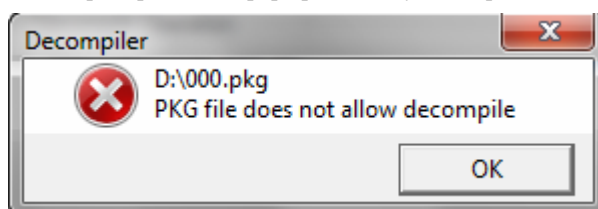

10.1.4 Download Password Protection

Set download password to HMI, to prevent user project saved in HMI being covered by unauthorized operation.

- Do not use download password

Projects do not use password by default. Settings of no use of password: Do not select the option of **Use Download Password** in **HMI Attribute** — **HMI Extended Attributes** page to do not use password. If download password is not set, the dialog box of download password will not pop up the next time when you download project into HMI. Users can download project into HMI directly.

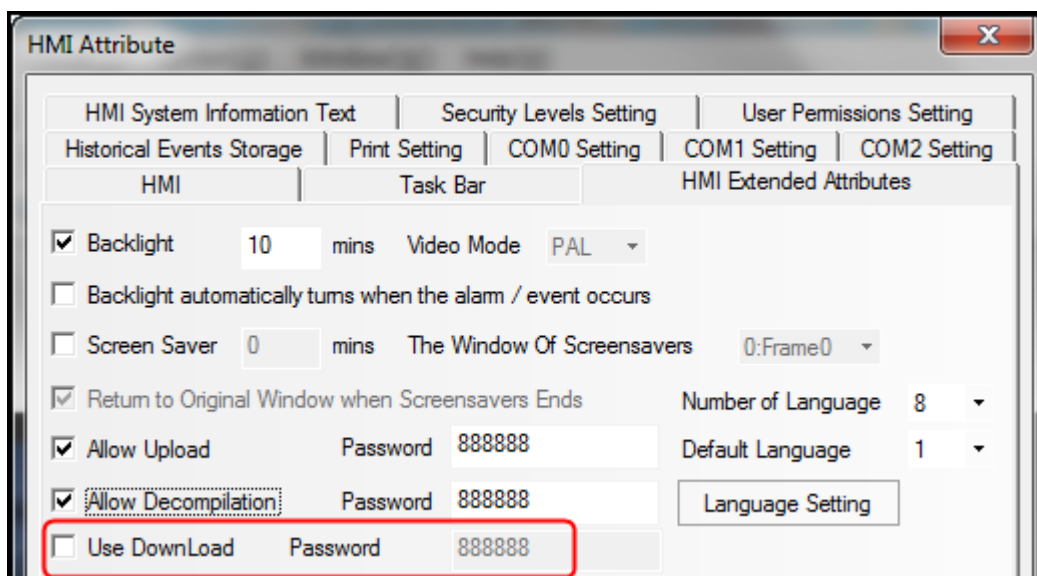

- Use password

Use password: Select the option of **Use Download Password** in **HMI Attribute** — **HMI Extended Attributes** page and set password. The default password is “888888”.

When project running in HMI is set to use download password, then **Download Password Dialog** box will pop up next time when user download project into HMI, as follows:

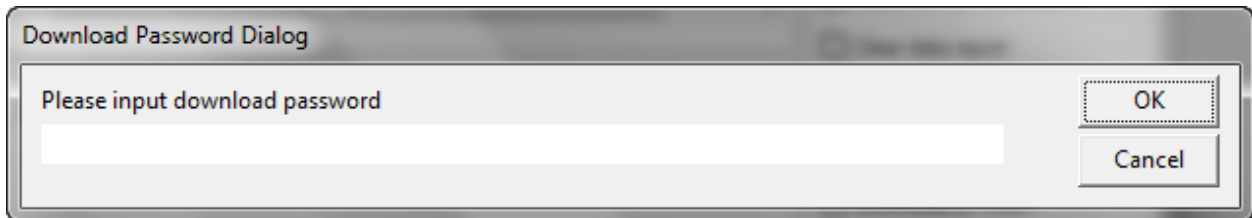

If input password is wrong, password error prompt will pop up.

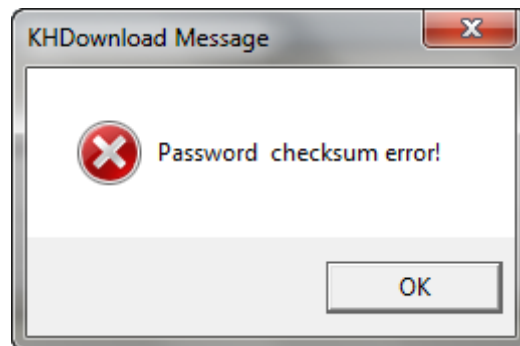

Only enter password correctly then project can be downloaded into HMI.



1. When set or modify download password in HMI attributes, users have to download project into HMI for the first time and restart HMI, then download password will take effect.
2. After the password is set, please keep it in mind, otherwise, configuration project download will fail. Manufacture does not provide factory recovery and universal password service.

10.2 Window Protection

For windows with important parameters or components, user could protect these important windows by security level function.

10.2.1 Window Password Setting

Set the number of security levels and corresponding passwords in **HMI Attribute** — **Security Levels Setting**, and system default passwords are “888888” .

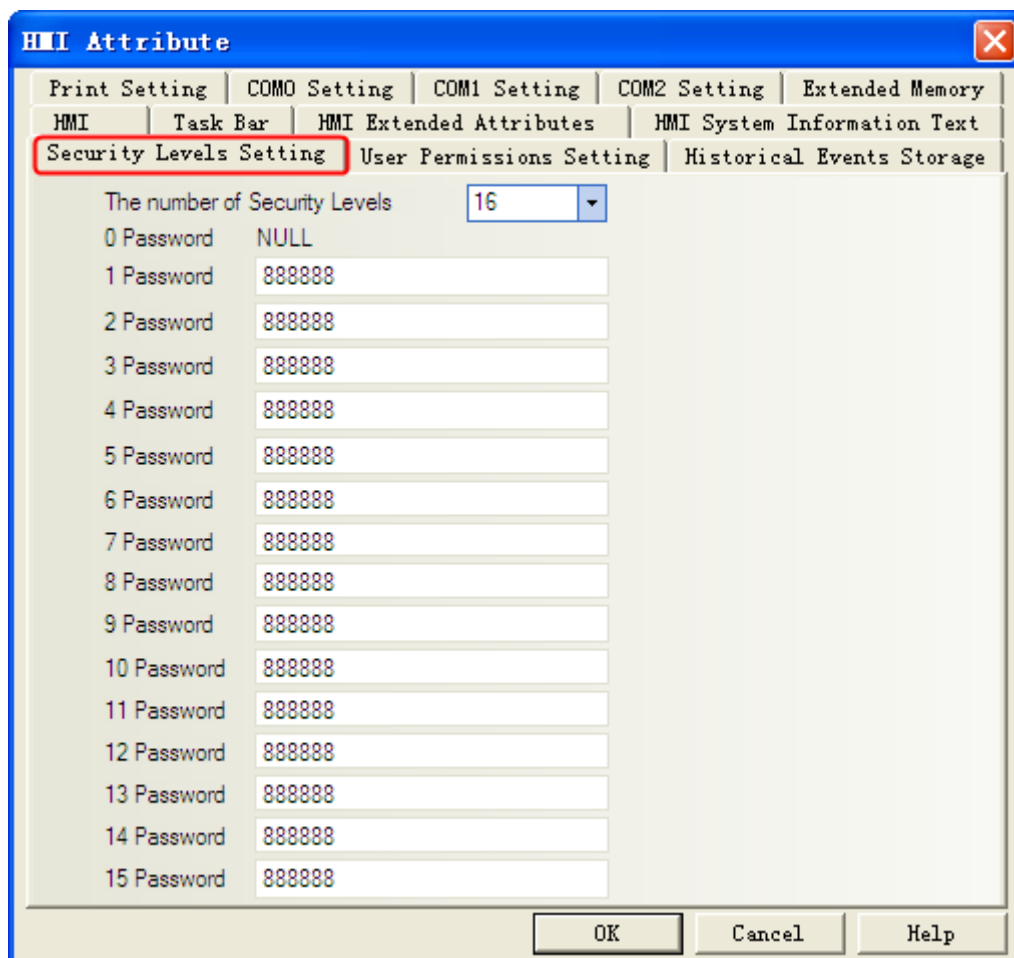

1. Support at most 16 security levels from 0 to 15. Level 0 indicates that there is no password; Level 15 is the highest security level. The bigger the number is the higher the level.
2. The password cannot be zero or empty; when passwords begin with 0, 0 is invalid.
3. The maximum value of password is 99999999.
4. Security level is valid only for base window and not available for other windows.
5. Users with high security level can access low security level windows; While users with low security level cannot access high security level windows.

10.2.2 Security Level Setting of Window

Access **【Window Attribute】** page— **【Security Level】** and choose the corresponding security level.

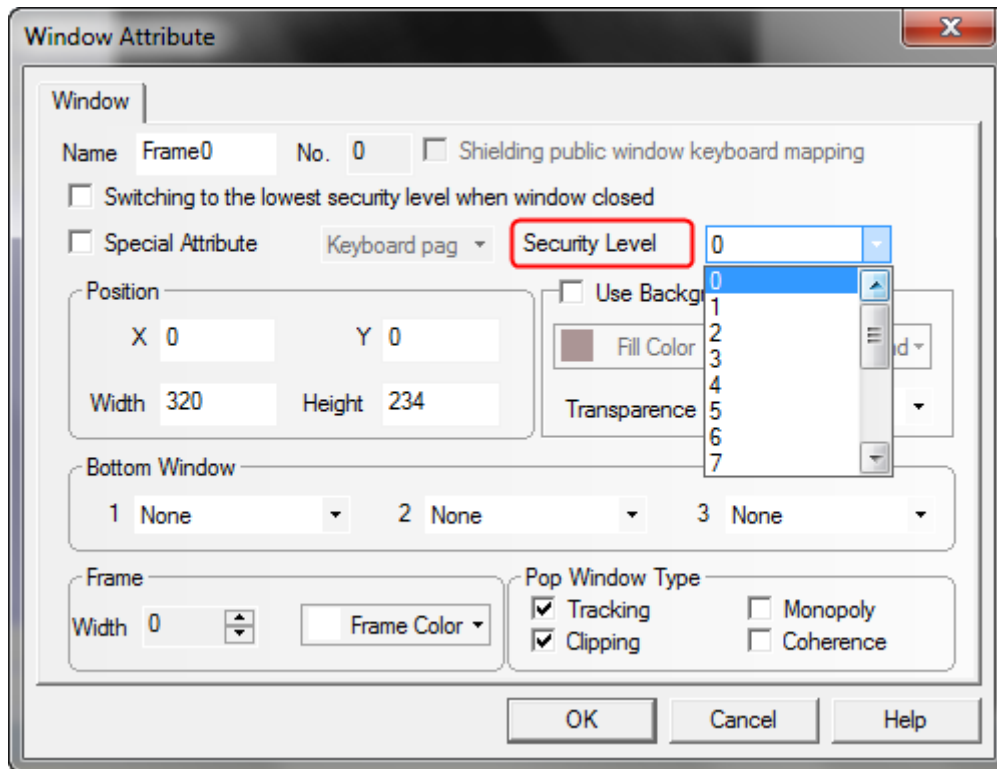

Software will remember the password input for the first time by default, as long as HMI is powered continuously, do not need to enter the password again when enter into the window next time.

If the option of **【Switching to the lowest security level when window closed】** is checked, then the password need to be entered again when accessing the window next time.

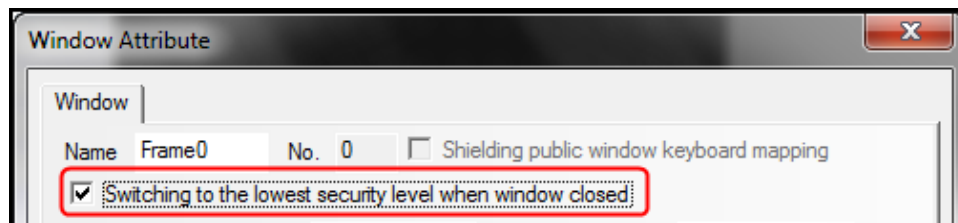

10.2.3 System reserved registers related to security level

Address	Description
LW9040~9041	Double words, is for inputting password of 【Security Level】
LW9042	Display the security level of current base window
LW9043	Force to lower the security level

10.2.4 Security level password input window

【Frame9: Login Window】 is provided by the system for security level password input.

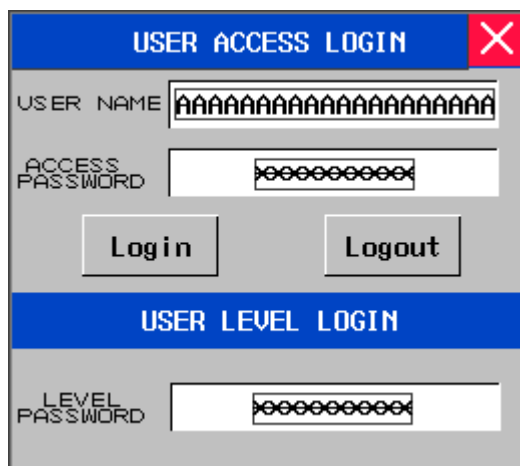

[Frame9: Login Window] is for inputting passwords of security levels and user permissions. User using security level function only need to input appropriate password of security level.



1. The system reserved registers referred in **【Frame9: Login Window】** could be found in **【Chapter 14 Registers】** of this manual
2. User could move the window by the control bar on the top of **【Frame9: Login Window】**

10.2.5 Modifying Password Online

Kinco HMIware supports security level password modifying online.



User permission password does not support online modification

System reserved registers for modifying security levels

Addresses of system reserved registers	Description	Addresses of system reserved registers	Description
LW10024~10025	Level 1 password. Double word	LW10026~10027	Level 2 password. Double word
LW10118~10119	Level 3 password. Double word	LW10120~10121	Level 4 password. Double word
LW10122~10123	Level 5 password. Double word	LW10124~10125	Level 6 password. Double word
LW10126~10127	Level 7 password. Double word	LW10128~10129	Level 8 password. Double word
LW10130~10131	Level 9 password. Double word	LW10132~10133	Level 10 password. Double word
LW10134~10135	Level 11 password. Double word	LW10136~10137	Level 12 password. Double word
LW10138~10139	Level 13 password. Double word	LW10140~10141	Level 14 password. Double word
LW10142~10143	Level 15 password. Double word		

10.2.6 Application of Passwords Required for Switching Windows

The following example describes how to protect the window by the security level function.

【Example】 Switch the window from window 0 to window 10 by switch window function of “Function Key” component, the window will switch only when the password is entered correctly.

In this example, set security level of window 0 to 0, set security level of window 10 to 1 and the password is 123456.

① Set security level password

In the attribute page of **【HMI Attribute】** — **【Security Level Setting】**, set level 1 password to 123456.

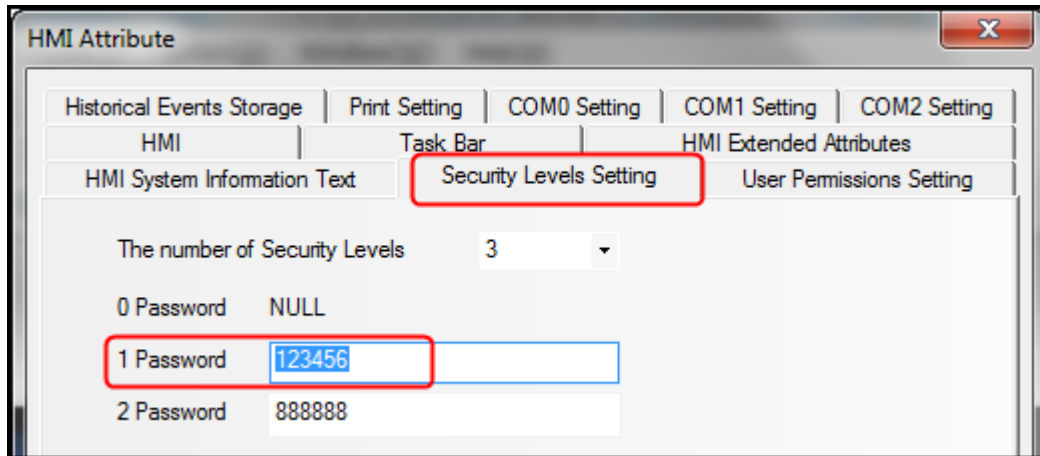

② Create a Function Key component in window 0, and the attributes setting is as follows:

Function	Switch Window: Chang window 【10: Frame10】
Tag	Use Tag; State 0: Switching window 10; State 1: Switching window 10.
Graphics	<p style="text-align: center;">State0 State1</p> <div style="display: flex; justify-content: center; gap: 20px;"> <div style="border: 1px solid gray; width: 40px; height: 40px; background-color: #cccccc;"></div> <div style="border: 1px solid gray; width: 40px; height: 40px; background-color: #cccccc;"></div> </div> <p>Use vector graphics:</p>
Control Setting	Select 【Conditional Enabling】 ; Check 【Security Level】 ; Check 【Minimum level: 1】 ; Check 【Auto show login window】 .

③ Set the attributes of window 10 and create a Function Key component to switch to window 0.

Double click at the blank area of window 10 to open the **【Window Attribute】** , and set its attributes as follows:

Security Level	1
Switching to the lowest security level when window closed*	Check

※ When the option is checked, the current window will be set to the lowest security level when window closed. Password is required to input again when access high level windows;

When the option is not checked, there is no need to input password when access windows with the same security level.

Set the attributes of Function Key as follows:

Function	Switch Window: Chang window 【0: Frame0】
Tag	Use Tag; State 0: Switching window 0; State 1: Switching window 0.

Graphics	State0 State1 
	Use vector graphics: <input type="checkbox"/>

4 Save and compile

During running, touch Function Key component in window 0 to pop up password input window **【Frame9: Login Window】**, and input “123456” to the **【LEVEL PASSWORD】** box to switch to window 10.

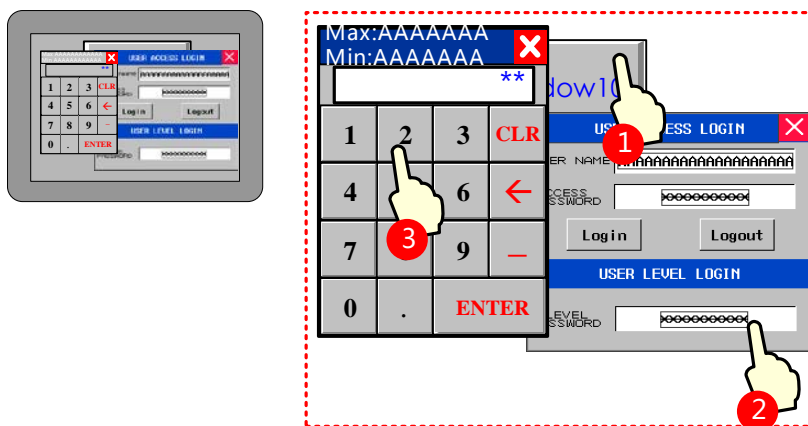

10.3 Component Protection

Some important components are set with permission /security level control. Only users with higher or equal permission/ security level could operate to prevent wrong operation.

There are two ways for component protection: security level protection, user permission protection.

10.3.1 Security Level Protection for Components

Settings of Security level protection for components are similar with window protection.

[For more details about components using \[Security level protection\], please refer to \[Advanced Part 10.2.6 Application of passwords required for switching windows\]](#)

10.3.2 User Permission Protection for Components

When **【Permission control】** is set to a component, then only users with corresponding permission can operate this component.

- User name and access password setting

Open **【HMI Attribute】** — **【User Permissions Setting】**, in the box of **【User Permissions Setting】**, select **【Enabled】** and input User Name, Password, Logoff Time and Permissions.

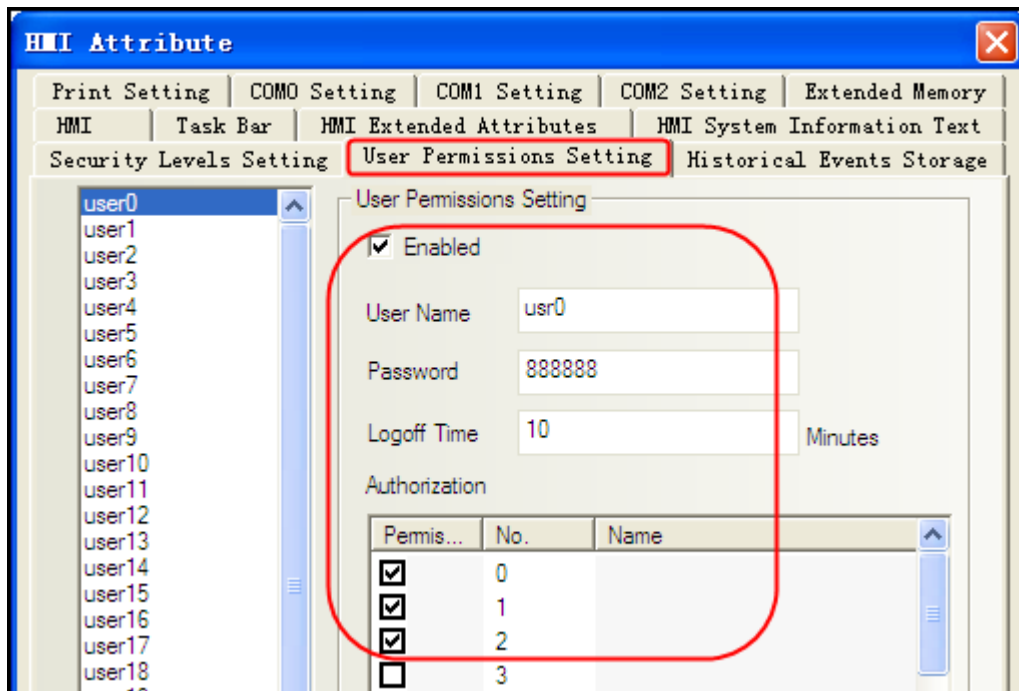

1. Password only supports number, but does not support other characters. The range of password is 0~2147483647. When password is set to 0, indicating no password in use.
2. Range of logout time is 0~2147483647 minutes. 0 indicates that do not log off and permission remains in effect. The logoff time is timed from the last time operation finished after login.

10.3.3 System Reserved Registers Related to User Permissions

Besides set user permission in **【HMI Attributes】** — **【User Permissions Setting】**, the following system reserved registers can also be used for user permissions setting:

Address	Function	Description
LW9486~LW9501	Input user name for login	32 characters at most
LW9502~LW9503	Input user password for login	Double word
LW9504~LW9505	Display permission of current user	Double word , read only, display 32 bits corresponding permission
LB9165	User login confirmation	Set ON to execute login operation, then set OFF automatically
LB9166	User logout confirmation	Set ON to execute logoff operation, then set OFF automatically

10.3.4 System Reserved Registers Related to Add/Delete Users and User Permissions Online

Besides add/delete users and user permissions in **【HMI Attributes】** — **【User Permissions Setting】**, user also can add/delete users and user permissions online. See the table below for system reserved registers related to add/delete users and user permissions online:

Address	Function	Description
LW9486~LW9501	Input user name for login	32 characters at most
LW9502~LW9503	Input password corresponding to user name	Double word
LW9506~LW9507	User permission assignment	Double words, readable/writable, 32 permissions assignment, LW 9506~9507 corresponds to permission 0~31 separately. LW.B corresponds to bits of LW 9506~9507. For example: LW.B 9506.0 indicates permission no. 0. LW.B 9506.A indicates permission no. 10
LW9508~LW9509	Logout time for user permission	Double words, in minutes
LW9510~LW9511	Confirm password for adding/deleting user	Double word
LB9167	Confirm to add user	Set ON to execute adding user, then set OFF automatically
LB9168	Confirm to delete user	Set ON to execute deleting user, then set OFF automatically
LB9190	Executive mark of user management	The bit will be set to ON when execute operations of Add/Delete users
LB9191	Operation failure of user management	The bit will be set to ON when operation of user management fails



1. Only users and user permissions added online can be deleted online.
2. User permissions do not support modify passwords online, but user could modify password through adding/deleting users online.

10.3.5 Window for User Permission Password Input

【Frame9: Login Window】 is provide by the system to input user permission password.

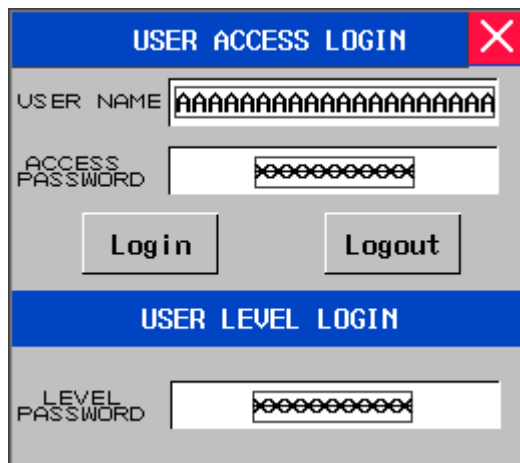

If user permission function is use, users only need to input corresponding “USER NAME” and “ACCESS PASSWORD” then click “Login” .



1. System reserved registers referred in **【Frame9: Login Window】** can be found in **【Chapter 14 Registers】** .
2. User could move **【Frame9: Login Window】** by the control bar on the top of the window.

10.3.6 Application of Security Level Protection for Components

【Example】 Correct password required before operation of “Bit State Switch” component.

In the example, security level is used to protect component, and set minimum level at least 2 to operate this component.

- ① Open **【HMI Attributes】** — **【Security Levels Setting】** . Detailed settings are as follows:

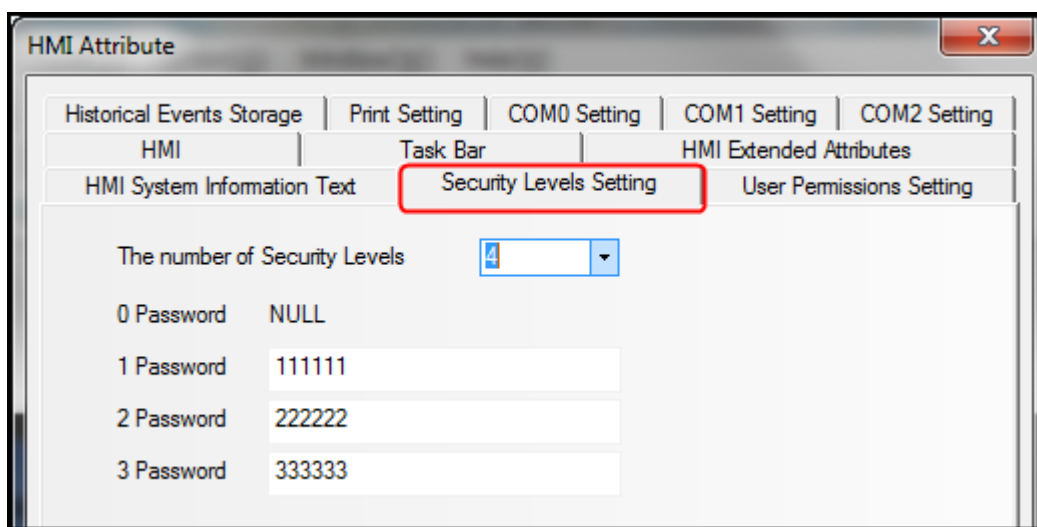

- ② Create a bit state switch component in window 0, and set its attributes as follows: address LB0. Switch Type: Toggle.
【Control Setting】—**【Conditional Enabling】**—**【Security Level】**—**【Minimum level: 2】**—**【Auto show login window】**.

Read/Write address	LB 0 (HMI local register)
Switch Type	Toggle
Graphics	<p style="text-align: center;">State0 State1</p> <div style="display: flex; justify-content: center; gap: 10px;"> <div style="border: 1px solid gray; width: 30px; height: 30px; background-color: #ccc;"></div> <div style="border: 1px solid gray; width: 30px; height: 30px; background-color: #ccc;"></div> </div> <p>Use Vector Graphics:</p>
Control Setting	Select 【Conditional Enabling】 ; Check 【Permission Control】 ; Check 【Select Permission : 2】 ; Check 【Auto show login window】

- ③ Save and compile

During running, when touch the bit state switch component, password input window **【Frame9: Login Window】** will pop up, then input level 2 password “222222” or level 3 password “333333” in the password level box. After confirm, user could operate the bit state switch component; If input level 1 password or wrong password, then the operation will fail.

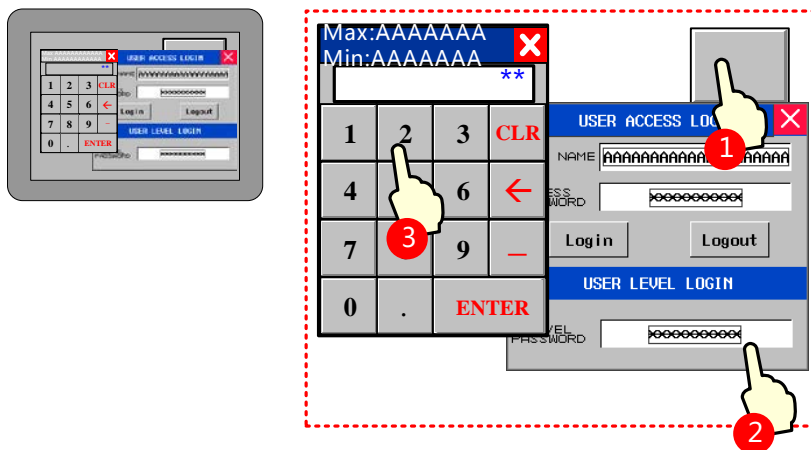

10.3.7 Application of User Permission Protection for Component

【Example】 Set 3 users: Administrator, Engineer, Operator. The 3 users have different permissions. Operator can operate number input component; Engineer can operate bit state switch component; Administrator can operate both the number Input component and bit state switch component.

User ID	User Name	Password	Logoff Time	Permission
User 0	Operator	111111	10 minutes	Operator permission
User 1	Engineer	222222	10 minutes	Engineer permission
User 2	Administrator	333333	1 minutes	Operator permission and engineer permission

① Registered user and corresponding permission in **【HMI Attribute】** — **【User Permission Setting】** , the settings are as follows:

User 0: Enable	User Name	Operator		
	Password	111111		
	Logoff Time	10		
	Permission	Permission 0: Operator permission	Check	
		Permission 1: Engineer permission	Uncheck	
User 1: Enable	User Name	Engineer		
	Password	222222		
	Logoff Time	10		
	Permission	Permission 0: Operator permission	Uncheck	
		Permission 1: Engineer permission	Check	
User 2: Enable	User Name	Administrator		
	Password	333333		
	Logoff Time	1		
	Permission	Permission 0: Operator permission	Check	
		Permission 1: Engineer permission	Check	

② Set user permission control for components

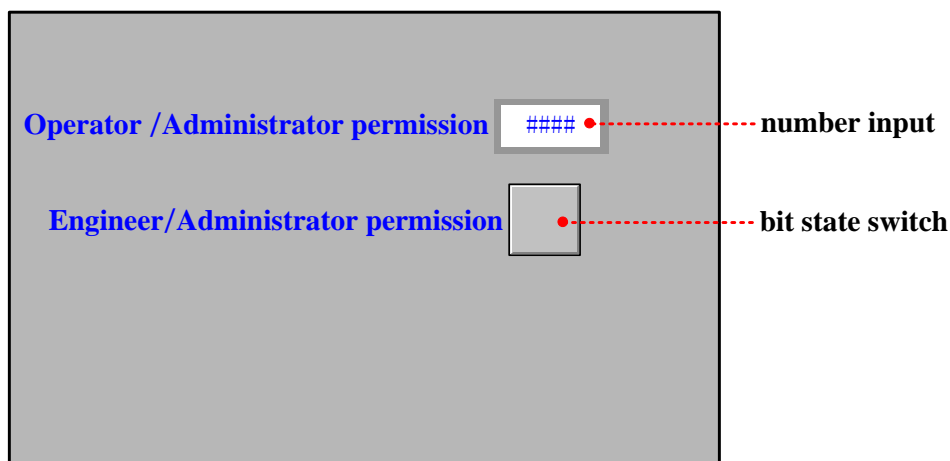

Create a number input component and a bit state switch component, and the attribute setting is as follows:

Number input component

Read/Write address	LW 0 (HMI local register)
Graphics	State0 Use vector graphics:
Control Setting	Select 【Conditional Enabling】 ; Check 【Permission Control】 , Select Permission: 0 Operator permission; Check 【Auto show login window】

Bit state switch component

Read/Write address	LB 0 (HMI local register)
Graphics	State0 State1 Use vector graphics:
Control Setting	Select 【Conditional Enabling】 ; Check 【Permission Control】 , Select Permission: 1 Engineer permission; Check 【Auto show login window】

③ Save and compile

During running, touch number input component to pop up password input window **【Frame9: Login Window】**, and input “Operator” to the **【USER NAME】** box and“111111”to the **【ACCESS PASSWORD】** box. Then click **【login】** to login Operator permission. Now user can operate the number input component. Operations for other components are similar.

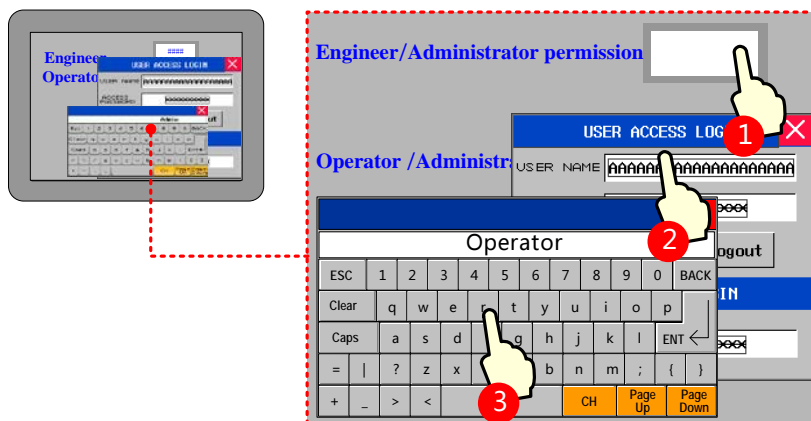

1. Logoff time: it is the valid time after login, user permission will be lapsed automatically after the time limit.
2. User name is case sensitive.

[Example] Add/Delete user permissions: Take MT5420 for example:

(1) Window 0

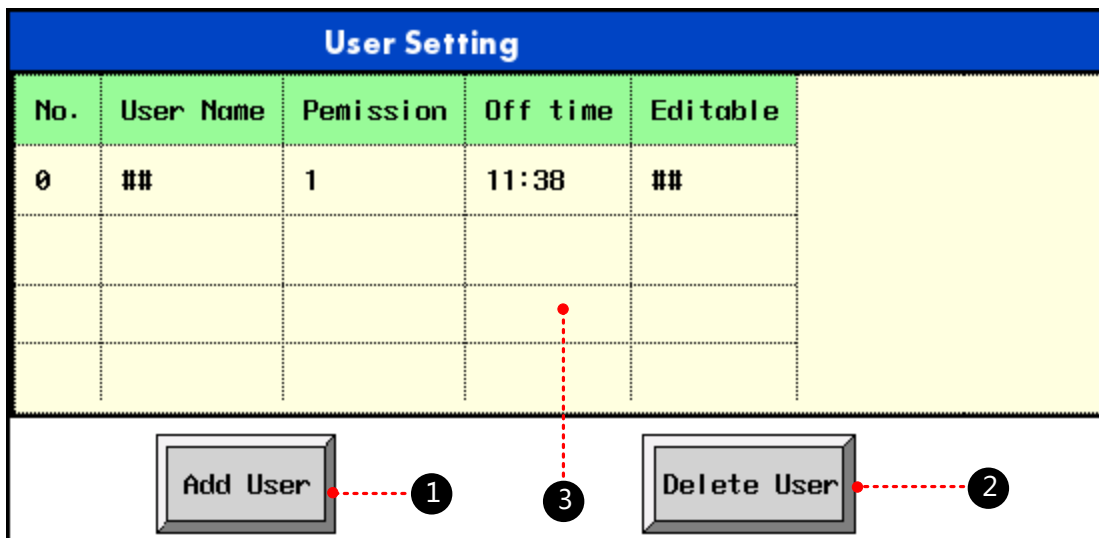

① Function key component is used to pop up window 10, and attribute settings are as follows:

Function	Switch window: popup window
Graphics	State0 State1  Use vector graphics:
Tag	Use Tag: Add user

② Function key component is used to pop up window 11, and attribute settings are as follows:

Function	Switch window: popup window
----------	-----------------------------

Graphics	<p style="text-align: center;">State0 State1</p>  <p>Use vector graphics:</p>
Tag	Use Tag: Add user

③ User info display component is used to display user' s information, and attribute settings are as follows:

Separator Setting	Color: Black; Style: -----
Background Setting	Background Color: White; Title Bar Background Color: Green; Border Color: Black
Border Width	2

(2) Window 10

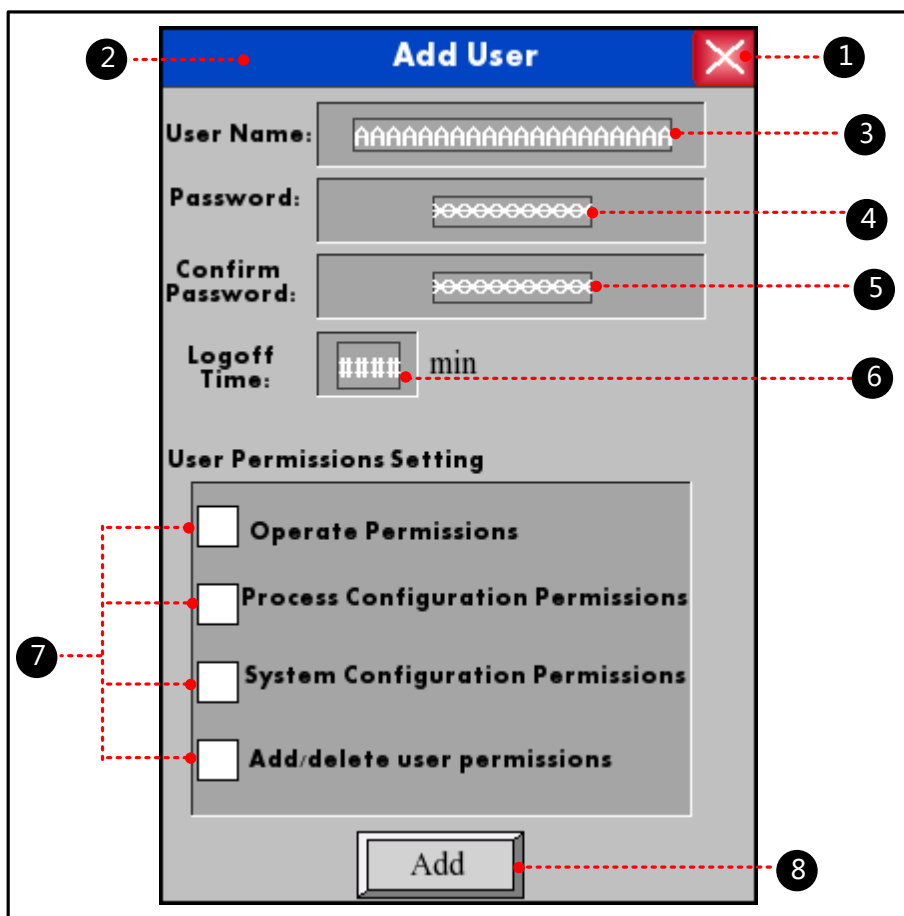

① Function key component is used to close keyboard, and attribute settings are as follows:

Function	Keyboard Function: Escape
Graphics	<p style="text-align: center;">State0 State1</p>  <p>Use vector graphics:</p>

② Function key component is used to move keyboard, and attribute settings are as follows:

Function	Switch Window: Popup window title bar
----------	---------------------------------------

Graphics	<p style="text-align: center;">State0 State1</p> <div style="display: flex; justify-content: center; gap: 20px;"> <div style="width: 20px; height: 20px; background-color: #003366; border: 1px solid black;"></div> <div style="width: 20px; height: 20px; background-color: #3399FF; border: 1px solid black;"></div> </div> <p>Use vector graphics:</p>
----------	--

③ Text input component is used to input user name, and attribute settings are as follows:

Read/Write address	LW9486
Word Length	10
Graphics	None

④ Number input component is used to input password, and attribute settings are as follows:

Read/Write address	LW9502
Numeric Data	Word Length: 2 words; Data Type: 【password】 ; Data Width 【DWORD】
Graphics	None

⑤ Number input component is used to confirm password, and attribute settings are as follows:

Read/Write address	LW9510
Numeric Data	Word Length: 2 words; Data Type: 【password】 ; Data Width 【DWORD】
Graphics	None

⑥ Number input component is used to set logout time, and attribute settings are as follows:

Read/Write address	LW9508
Numeric Data	Word Length: 2 words; Data Type 【unsigned int】 , Data Width 【DWORD】
Graphics	None

⑦ Bit state switch component is used to select user permissions, and attribute settings are as follows:

Write address	LW.B9506.0	LW.B9506.1	LW.B9506.2	LW.B9506.3
Switch Type	Toggle			
Tag	None			
Graphics	<p style="text-align: center;">State0 State1</p> <div style="display: flex; justify-content: center; gap: 20px;"> <div style="width: 20px; height: 20px; border: 1px solid black;"></div> <div style="width: 20px; height: 20px; border: 1px solid black; position: relative;"> / </div> </div> <p>Use vector graphics:</p>			

⑧ Bit state setting component is used to confirm to add users, and attribute settings are as follows:

Write address	LB9167
Switch Type	On
Tag	Use Tag, 0: Add
Graphics	<p style="text-align: center;">State0 State1</p> <div style="display: flex; justify-content: center; gap: 20px;"> <div style="width: 20px; height: 20px; background-color: #cccccc; border: 1px solid black;"></div> <div style="width: 20px; height: 20px; background-color: #cccccc; border: 1px solid black;"></div> </div> <p>Use vector graphics:</p>

(3) Window 11

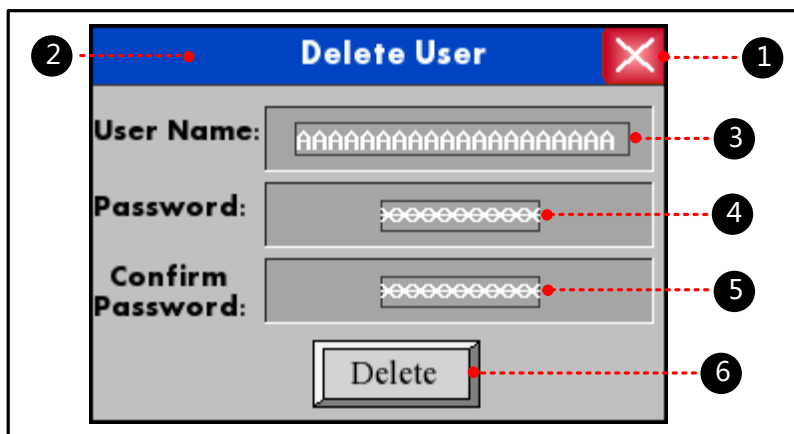

1 Function key component is used to close keyboard, and attribute settings are as follows:

Function	Keyboard Function: Escape				
Graphics	<table style="margin-left: auto; margin-right: auto;"> <tr> <td style="text-align: center;">State0</td> <td style="text-align: center;">State1</td> </tr> <tr> <td style="text-align: center;"></td> <td style="text-align: center;"></td> </tr> </table> <p>Use vector graphics:</p>	State0	State1		
State0	State1				

2 Function key component is used to move keyboard, and attribute settings are as follows:

Function	Switch Window: Popup window title bar				
Graphics	<table style="margin-left: auto; margin-right: auto;"> <tr> <td style="text-align: center;">State0</td> <td style="text-align: center;">State1</td> </tr> <tr> <td style="text-align: center;"></td> <td style="text-align: center;"></td> </tr> </table> <p>Use vector graphics:</p>	State0	State1		
State0	State1				

3 Text input component is used to input user name, and attribute settings are as follows:

Read/Write address	LW9486
Numeric Data	10
Graphics	None

4 Number input component is used to input password, and attribute settings are as follows:

Read/Write address	LW9502
Numeric Data	Word Length: 2 words; Data Type: password ; Data Width DWORD
Graphics	None

5 Number input component is used to confirm password, and attribute settings are as follows:

Read/Write address	LW9510
Numeric Data	Word Length: 2 words; Data Type: password ; Data Width DWORD
Graphics	None

6 Bit state setting component is used to confirm to delete users, and attribute settings are as follows:

Write address	LB9168
Switch Type	On
Tag	Use Tag; 0: Delete

Graphics	State0 State1  Use vector graphics:
----------	--



Delete user permission is only valid for the users added in HMI. Users set in the configuration project cannot be deleted

(4) Save, compile and offline simulation

- Touch the **【Add User】** button, add user dialog box will pop up.

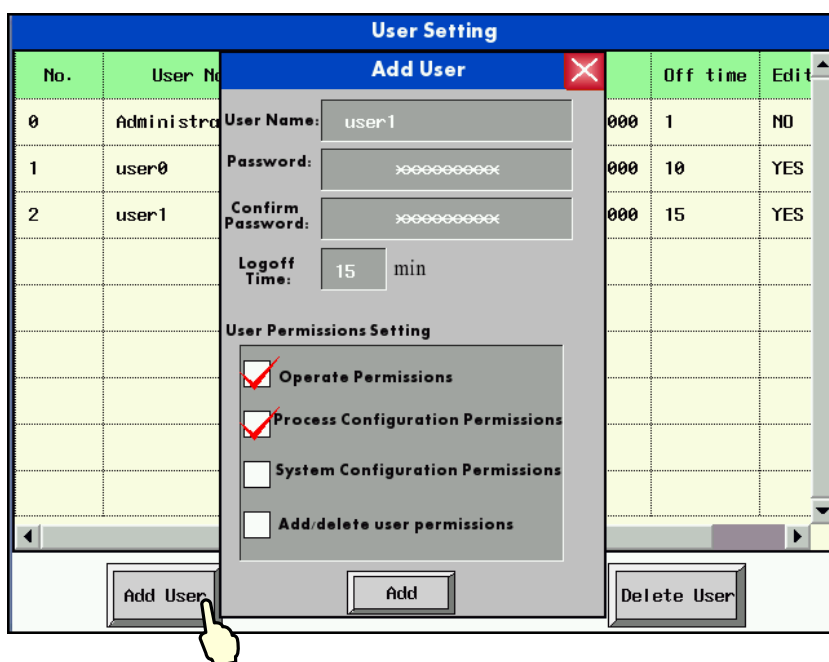

Input the user name to be added and the corresponding password, confirm it, then click “Add” to complete the operation.

- Touch the **【Delete User】** button, delete user dialog box will pop up.

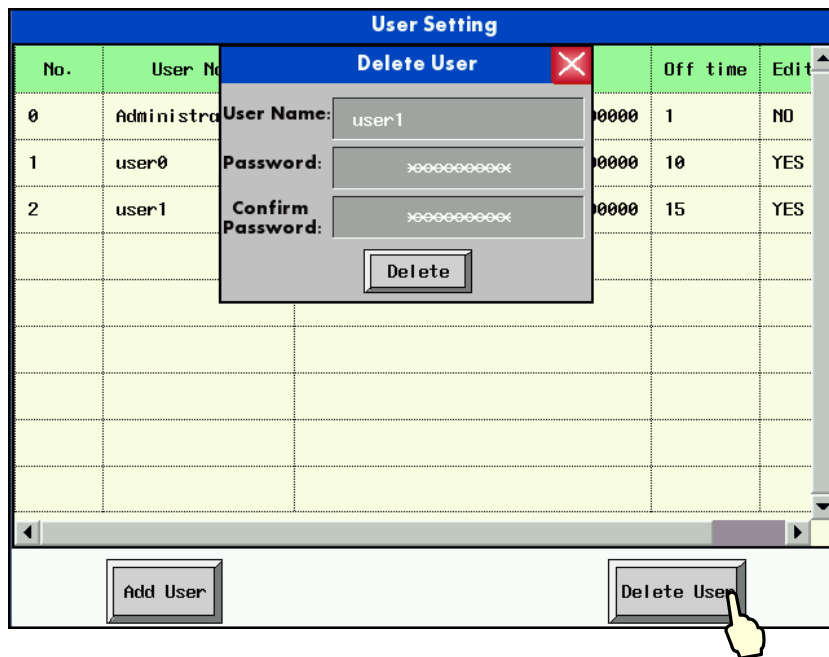

Input the user name to be deleted and the corresponding password, confirm it, and then click “Delete” to complete the operation.

【Example】 Delete user by administrator permission. There are two users in the project as follows:

	User 1	User 2
User Name	A	B
Password	111	222
Permission	1.Add/delete permission 2.Administrator permission	1.Add/delete permission

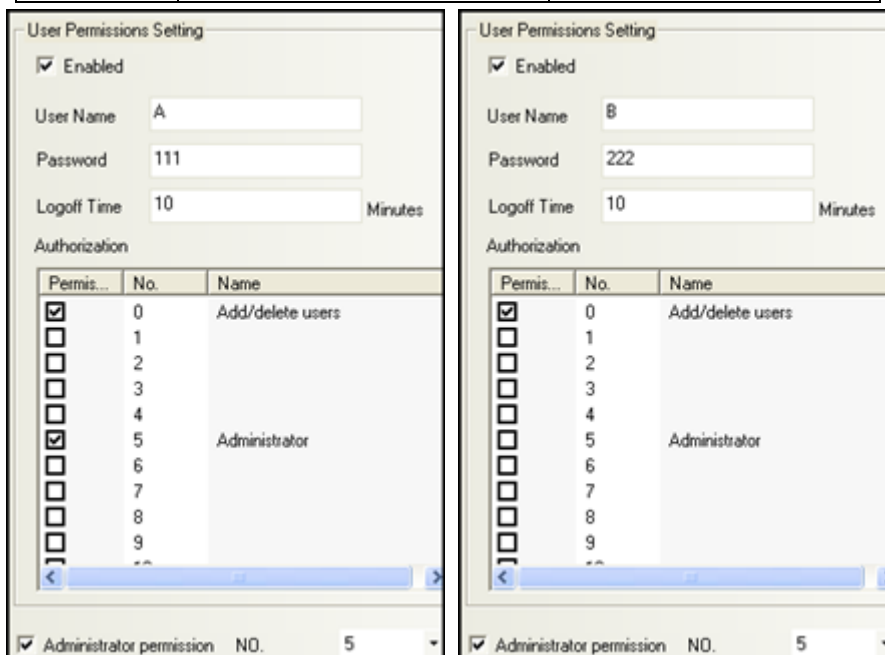

1) Add new user online, User Name: 1, Password: 123.

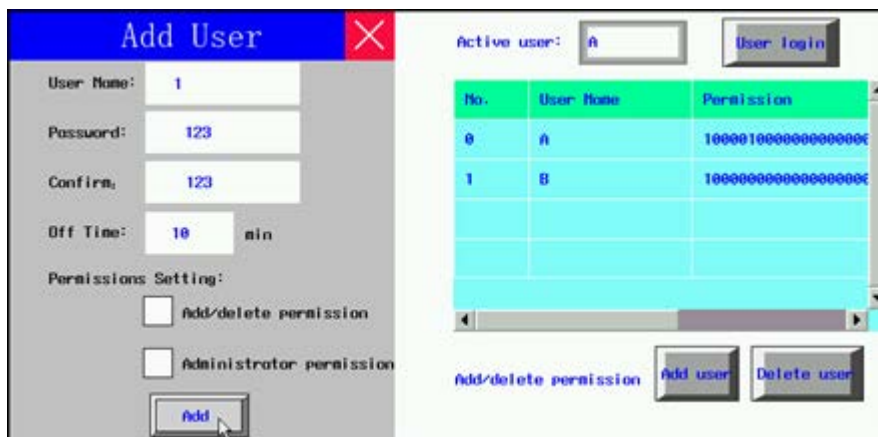

2) User B (No Administrator Permission) execute delete operation without password, it prompts “Password Error” , and delete operation is fails.

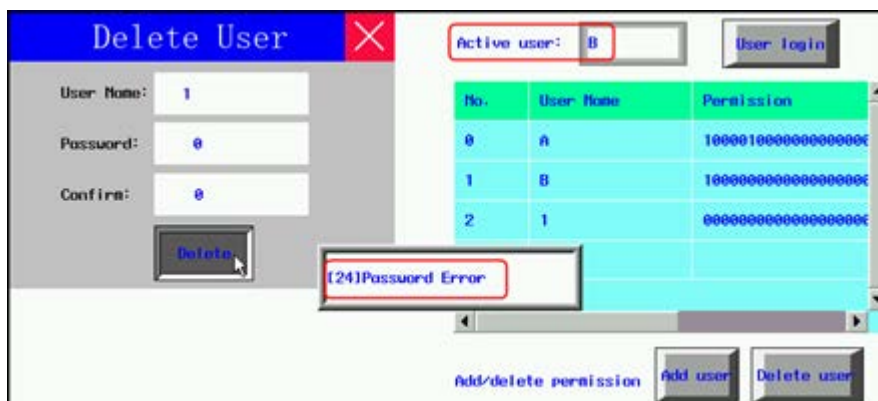

3) When User A (Check Administrator Permission) execute delete operation without password, it prompts “Operation Complete” , and delete operation is complete.

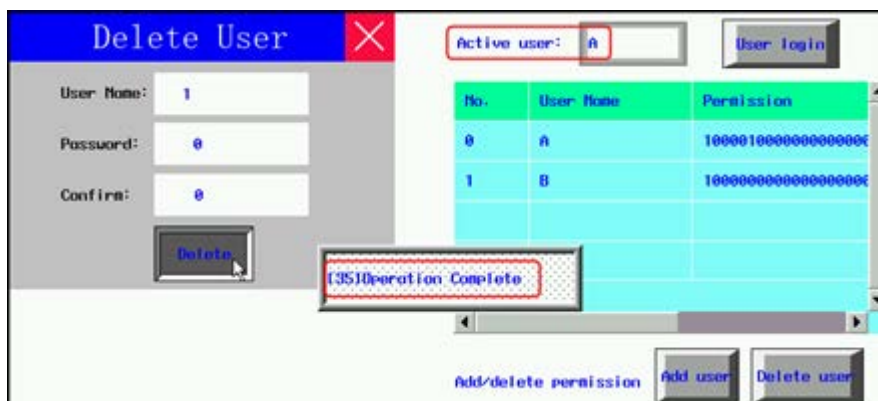

11 Recipe/ RecipeEditor

Recipe data is saved on the HMI and can be stored inside the area power down. Recipe data can be stored in the RW and FRW register. For with USB HOST interface or SD card slot on the HMI, the recipe data can also be stored in the ERW register.

RW, FRW and ERW distinction as follows:

Recipe Register	Description
RW	RW is specially designed for HMI recipe memory physical storage area that is defined by the address type. When the HMI is powered down, RW in 4000 series remains . RW in 5000 series depends on backup battery . If it is powerfui,data remains,but back-up battery power is low, or when no electricity, RW data will be lost.
FRW	FRW is dedicated to the physical storage area HMI FLASH address type definition. The data stored in FLASH FRW, not because of HMI powered off or HMI backup battery power and loss of data. But there are erasing times limit FLASH
ERW0~2	ERW0 ~ 2 is dedicated to the physical storage area defined in the external memory address type. The data stored in the ERW, not because of HMI powered off or HMI backup battery is dead and losing data

RW, FRW, ERW using methods similar, the following content mainly RW, for example, no longer on the FRW and ERW additionally described.

11. 1 Register Related to the Recipe

Register/ Component	Descriptions
RB	The absolute addresses of the recipe bit addresses saved in the HMI.
RBI	The index addresses of the recipe bit addresses saved in the HMI.
FRB	The absolute addresses of the recipe bit addresses saved in the flash.
FRBI	The index addresses of the recipe bit addresses saved in the flash.
RW	The absolute addresses of the recipe word addresses saved in the HMI.
RWI	The index addresses of the recipe word addresses saved in the HMI.
FRW	The absolute addresses of the recipe word addresses saved in the flash.
FRWI	The index addresses of the recipe word addresses saved in the flash.
ERW0~2	The absolute addresses of the recipe word addresses saved in the external memory.
ERWI0~2	The index addresses of the recipe word addresses saved in the external memory.
LW9000	The data in LW9000 is the offset of the index address
Data Transmission	Transfer the data in recipe data to the data in PLC or HMI.
Timer	

Recipe Data
General PLC Control/ General PLC Control (Extend)

11.2 Method for Checking the Recipe Size

11.2.1 Method for Checking the RW Size

The capacity (RW size) is different from different types of HMI. Through the following ways user can check the RW size.

For example: Take MT5320T for example:

- Check in Kinco HMIware software

Move the mouse to the MT5320 icon in HMI in Graph element window, the system will automatically display the relevant information of this HMI. The [Recipe Size] is the RW size. The recipe size of MT5320T is 256k words that are 512 K Bits.

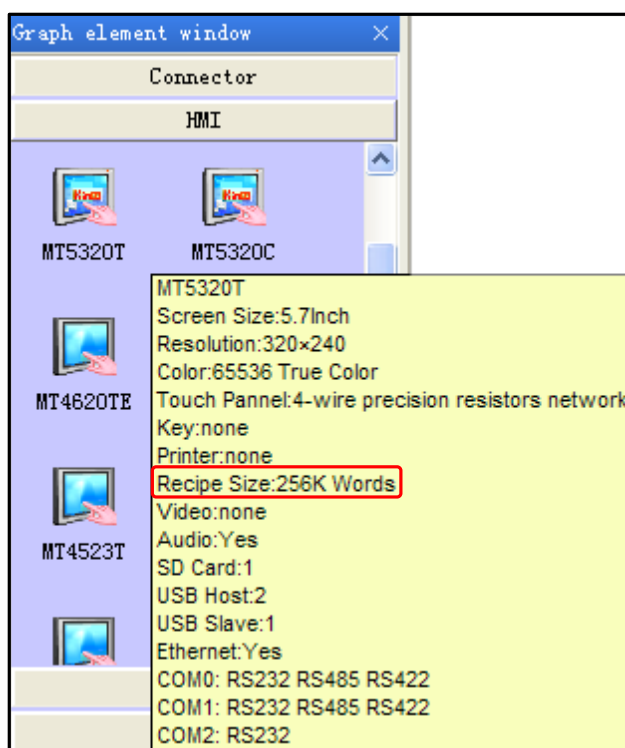

- Check in selection guide
- Check the recipe file attribute after uploading the recipe by KHManager

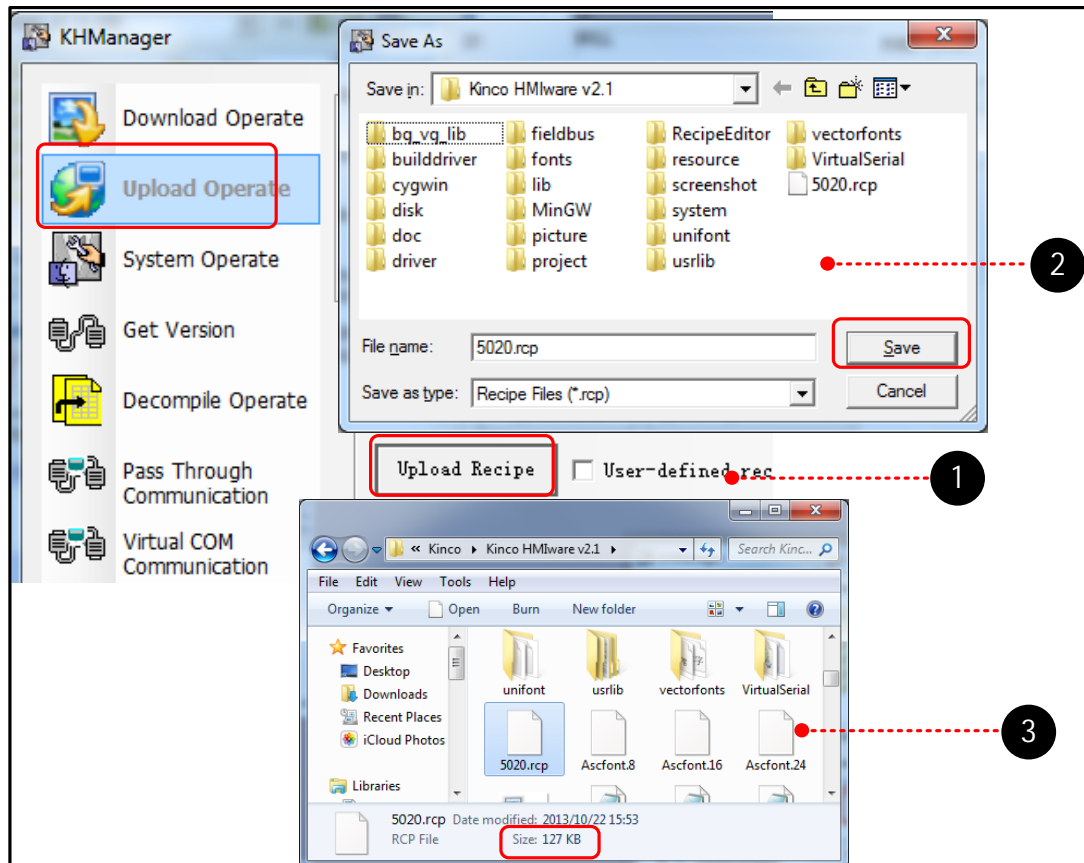

- ① Click [Upload Recipe] in [KHManager], and input [File Name], then click [Save].
- ② Recipe is uploading until the “Upload Success” dialog box pop up.
- ③ Check the size of recipe file uploaded.

11.2.2 Calculation for Recipe Address Range

There are two following ways for calculating HMI recipe address range.

- Calculation based on recipe size

[Example]: Take MT5320T for example, the recipe size is 256K words, that 256Kword= 512K Byte, and 1k byte is occupied by the system. The calculation is $(512-1) \times 1024 \text{ Byte} = 523264 \text{ Byte}$. Because Kinco HMIware are addressed in words, so bytes divided by 2 becomes the word address, and then the last three digits become 0, finally get 261000 words.

- View through the element address range

[Examples] For example create a new model for the MT5320T HMI configuration, in the Configuration Editor to create a new screen number input component, set the address type is RW, the user can view the MT5320T in the [address range], RW register address range is: 0 ~ 261000.

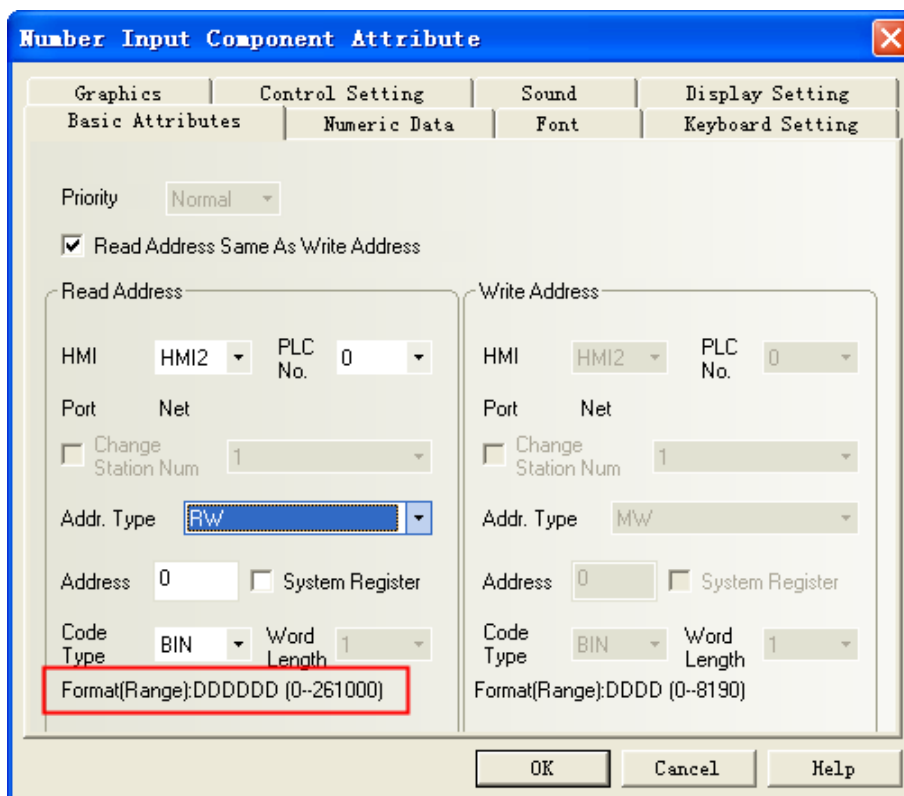

11.3 Usage of Recipe

11.3.1 Absolute Address

The recipe memory has an address corresponding recipe absolute addressing (It is assumed that the initial value of illustration only, to actually quasi) as shown:

Address	Default Value(10 decimal)
RW0	0
RW1	1
RW2	2
RW3	3
...	...
RWn	n

11.3.2 Index Address

Because absolute address too much, find it very difficult, so the index provides a virtual address of a temporary storage area RWI0, ..., RWIn and an index register LW9000 (occupies 2 words) by changing t LW9000 to find RW.

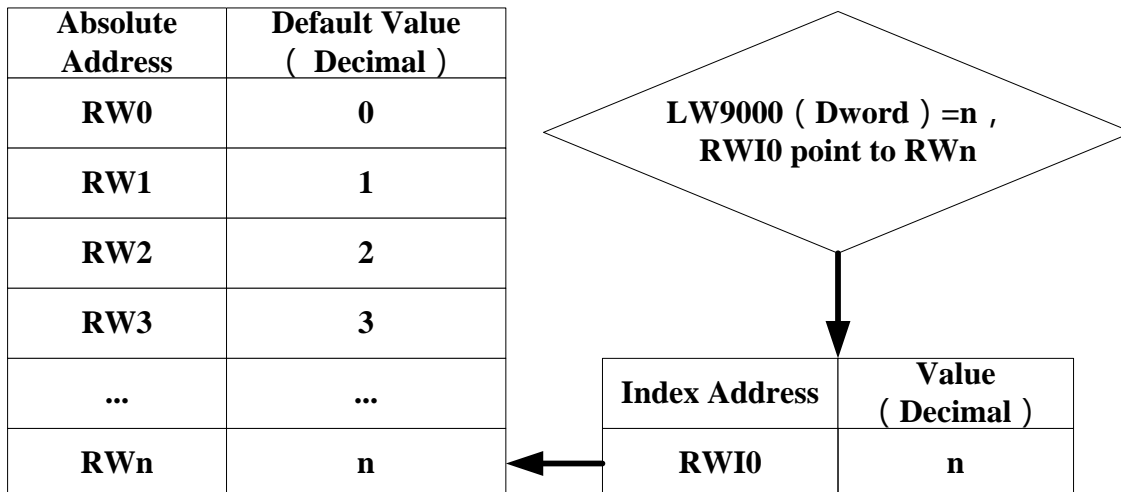

[Example] If the value of LW9000 is equal to 105, then the RWI0 will point to the data in address RW105.

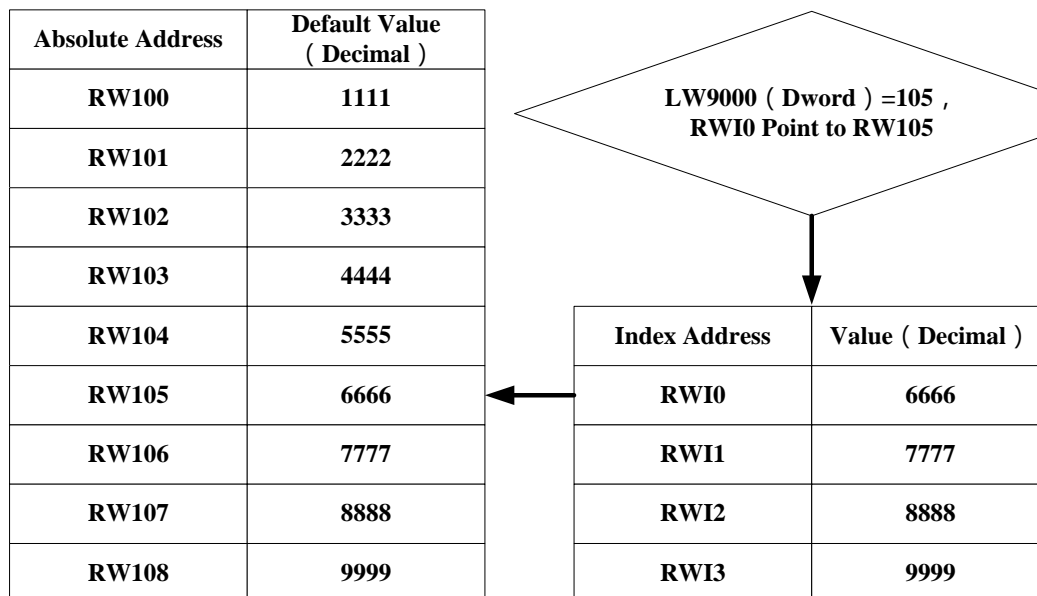

11.3.3 Application of Recipe

For example: We take the address 4x of Modbus RTU protocol for example, save the value of 4X1~4X5 to 0 recipe file and 1 recipe file. The address range of 0 recipe file is RW0~RW4, The address range of 1 recipe file is RW5~RW9.

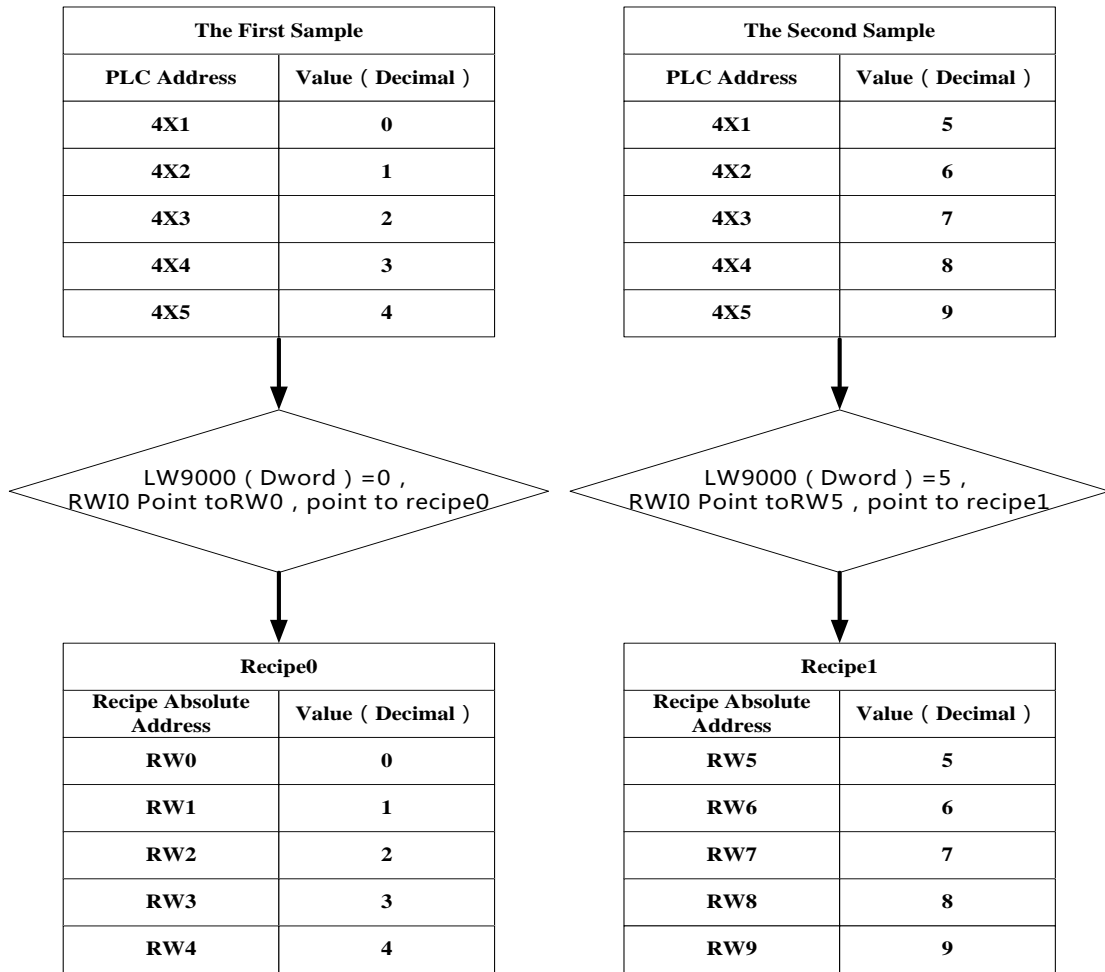

Configuration screen as shown:

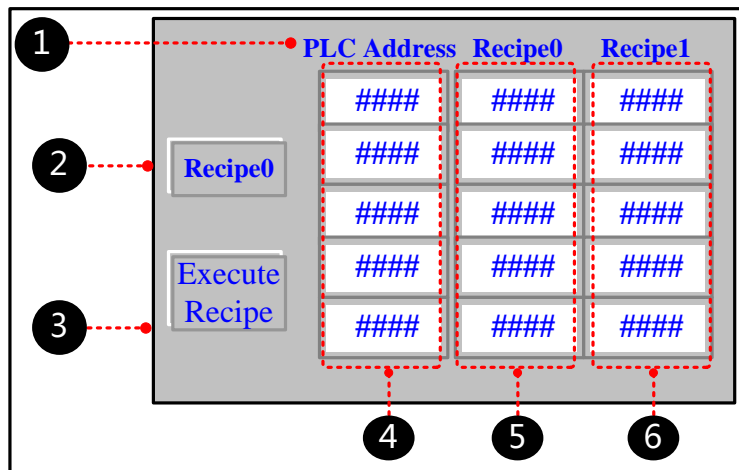

① Text: PLC address, recipe 0, recipe 1

② Multiple State Switch component used to change the value of LW9000, its attribute are:

Read/ Write address	LW9000 (HMI system special register)
Function	Control Mode: add, State Num.: 2, State No. 0 map value 0, State No. 1 map value 1

Graphics	<div style="display: flex; justify-content: space-around; align-items: center;"> State0 State1 </div> <div style="display: flex; justify-content: space-around; align-items: center;"> <input type="checkbox"/> <input type="checkbox"/> </div> <p>Use vector graphic:</p>
Tag	Use Tag: recipe 0, recipe 1

③ Recipe Data component transferring the value of PLC to RW, its attribute are:

Write Address	4X 1 (PLC register)
Function	Recipe Data: Upload from PLC to Recipe, Data Length: 5 words
Graphics	<div style="display: flex; justify-content: space-around; align-items: center;"> State0 State1 </div> <div style="display: flex; justify-content: space-around; align-items: center;"> <input type="checkbox"/> <input type="checkbox"/> </div> <p>Use vector graphic:</p>
Tag	Use Tag; 0: Execute Recipe

④ Number Input component inputting the value of the PLC register, its attribute are:

Read/ Write address	4X 1	4X 2	4X 3	4X 4	4X 5
---------------------	------	------	------	------	------

⑤ Number Display component displaying the value of RW0~4, its attribute are:

Read/ Write address	RW0	RW1	RW2	RW3	RW4
---------------------	-----	-----	-----	-----	-----

⑥ Number Display component displaying the value of RW5~9, its attribute are:

Read/ Write address	RW5	RW6	RW7	RW8	RW9
---------------------	-----	-----	-----	-----	-----

Run and input 0~4 in the PLC address 4X1~4X5, then press [Execute Recipe] button, the value of RW0~RW4 will display 0~4.

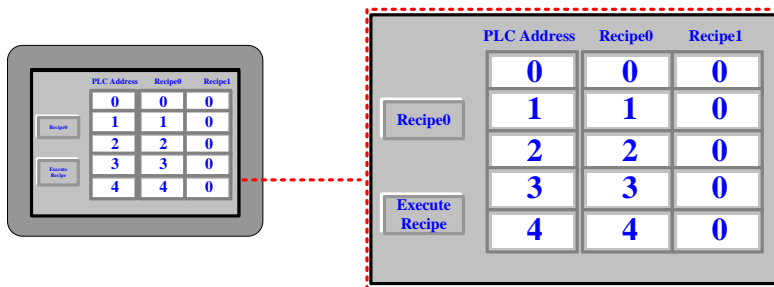

Press [recipe 0] button and switch to [recipe 1], and modify the value of PLC address 4X1~4X5 to 5~9, then press [Execute Recipe] button, the value of RW5~RW9 will display 5~9.

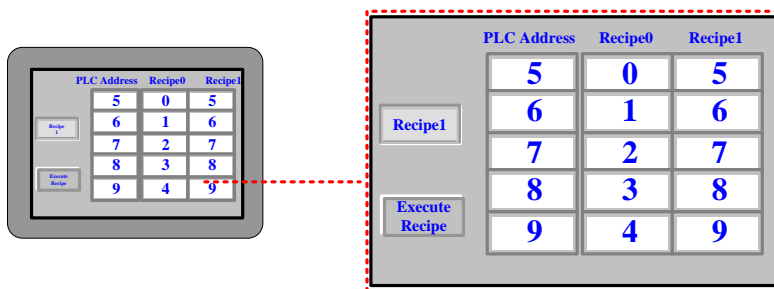

11.4 RecipeEditor

RecipeEditor is a tool in Kinco HMIware, and it is mainly used for the user to create, check, or edit the recipe file in *.rcp, *.csv, *.erp and *.frp format.



The data file in *.rcp, *.erp and *.frp format can save as *.csv file, and can open, check, edit or print by Excel.

File Format	Descriptions
rcp	HMI own the recipe memory corresponding recipe file format, using KHManager tool can upload and download files to the format of the recipe (which, file size depends on the HMI recipe memory size) It is the file format which can be identified by HMI
csv	It usually means the file format is based on the configuration settings and automatically saved to an external storage device or through the recipe editor to save. This particular binary file format, you can use Microsoft Excel software to open and can be to edit, save and print, and other related operations, but can not be freely modified template format, otherwise the recipe editor and HMI can not be resolved
erp	The file format only supported that the HMI with external memory, can be saved in USB DISK, SD card
frp	The recipe file format corresponding to the FLASH address, HMI will be only generated while used, supports a maximum address is 2G Bits, $2 \times 1024 \times 1024 \times 1024/16$ Words = 134217728 Words, when configuration, placed a number input element, the address type selection FRW, will see the range is 0-134217727. The number of FLASH recipe address using as the same as the HMI is open, when not in use will be released. Usually used to save the more important and not always erase the data, because the HMI powered off or battery power is not lost, but erasing times is limited. using KHManager tool can upload and download the recipe file format (upload FRW, download FRW)

11.4.1 Recipe Editor Start-up

- Open from the [Start] menu in the PC operation.
- Open from the [Tools] menu in Kinco HMIware.

Click [Recipe Editor] in the [Tools] menu.

- Double-click [RecipeEditor.exe] in the [RecipeEditor] file document in Kinco HMIware installation directory.

The RecipeEditor folder is copied to another location can be used alone.

- Click [Recipe Editor] button in [KHManager]-[Download Operate].

11.4.2 Recipe Editor User interface

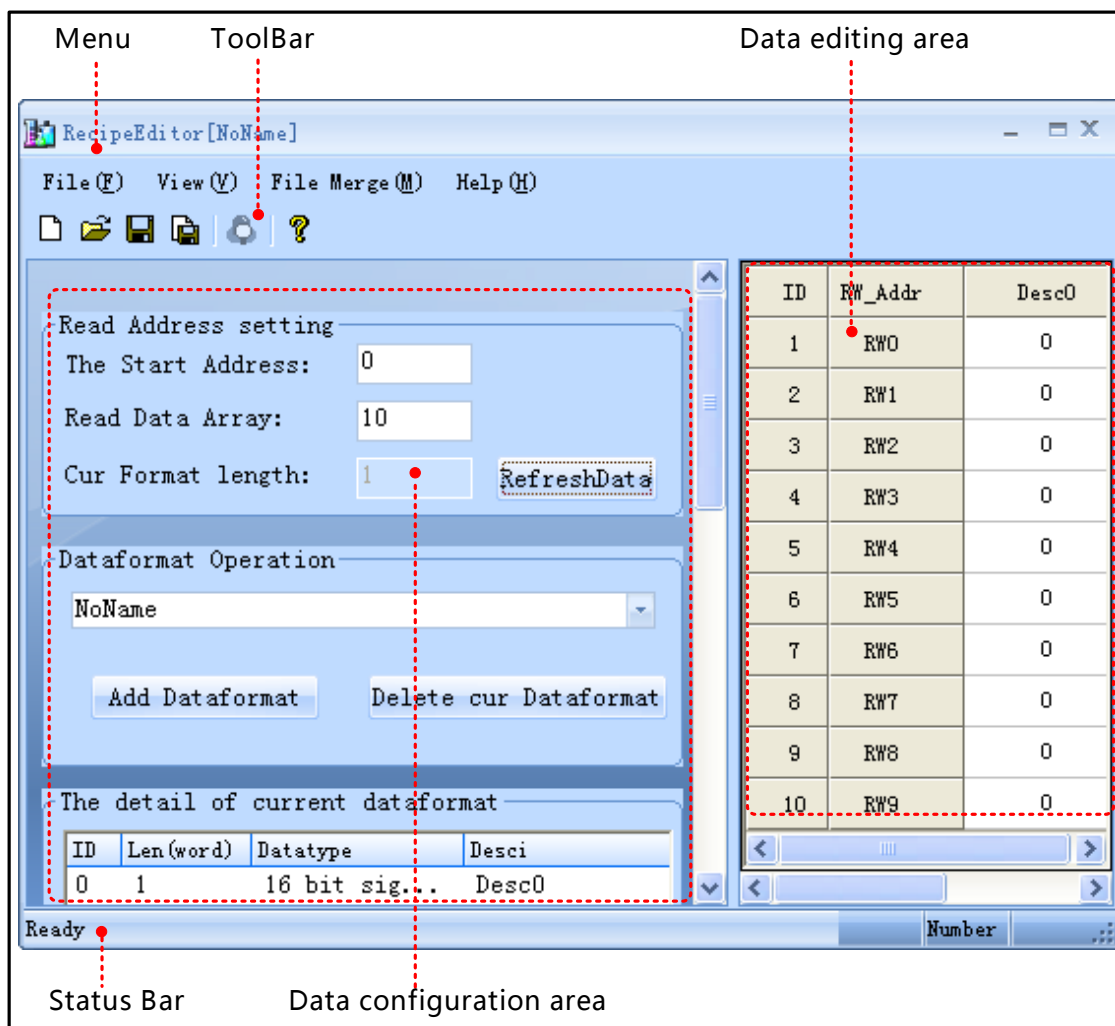

● Menu Bar/ Toolbar

Name	Icon	Toolbar name	Descriptions
File		New File	Create a new recipe file
		Open File	Open a recipe file
		Save File	Save recipe file
		Save As	Save as a recipe file
		Exit	Exit recipe editor
View		ToolBar	Start/ Close Toolbar
		Status Bar	Start/ Close Status Bar
File Merge		File Merge	HMI Merge some recipe files to a recipe file
Help		About RecipeEditor	The version of RecipeEditor
Bit Browser		Bit Browser	Display word register in bit format

● Data configuration area

There are [Read Address Setting], [Dataformat Operation], [The detail of current dataformat] and [Dataformat Operation]



Usage] in data configuration area.

Name		Descriptions
Read Address Setting	The Start Address	The start address of the reads data segment
	Read Data Array	The number of groups to read data
	Cur Format length	The sum length of each data type × the number of groups
	RefreshData	Click 【Refresh Data】 ,display data as a new setting
Dataformat Operation		Select the current data format
	Add Dataformat	Click 【Add Data format】 to add the data format
	Delete cur Dataformat	Click 【Delete cur Data format】 to delete the current data format
The detail of current dataformat	-	Select an entry, double click, pop [Data Type Editor] dialog; blank right-click menu, you can add, modify, delete data type
Dataformat Operation Usage	Auto use dataformat	After modify the data format, automatically read the current file
	Use Dataformat	With the same effect [Refresh Data]

● Data editing area

Data editing area according to [data configuration area] set the start address, the number of data and data types to display the corresponding register address, and the user can view and modify data area data corresponding to these addresses.

- Hide / Show [Data Configuration area]

Move the mouse to the control bar when the mouse is displayed as , pulling the control bar or click the left mouse button, you can hid [Data Configuration area]. At this moment move the mouse to place the control bar when the mouse is displayed as , pulling the control bar or click the left mouse button, you can restore the display [Data Configuration area].

- **【Data editing area】** to view, modify, and bit browser

Directly input data in the data field [Desc1] (eg.RW1-RW9 are input 1-9), select the data bar required to bit browser, the data bar turns blue, right-click or click  on the toolbar, can pop [bit browse] properties box.

ID	RW_Addr	Desc0
1	RW0	0
2	RW1	1
3	RW2	2
4	RW3	3
5	RW4	4
6	RW5	5
7	RW6	6
8	RW7	7
9	RW8	8
10	RW9	9

[Examples] For example RW9 value is 9, bit browser form RW9: 03,00 bit address can be seen in red: ON, decimal 9 to binary form as 0000 0000 0000 1001.

11.4.3 Usage of RecipeEditor

- (1) Add a new recipe file: If you use the RecipeEditor in the first time, you can click  icon in the toolbar and then can create a new recipe file.
- (2) Add Dataformat: Click [Add Dataformat] and input the new format name: e.g. "Mydata", then click [OK] button.

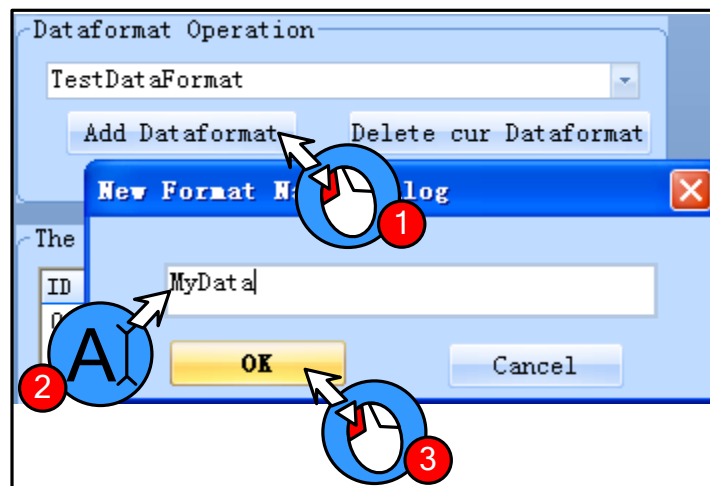

- (3) Add Data Item

- The procedure of adding data type is shown as below:

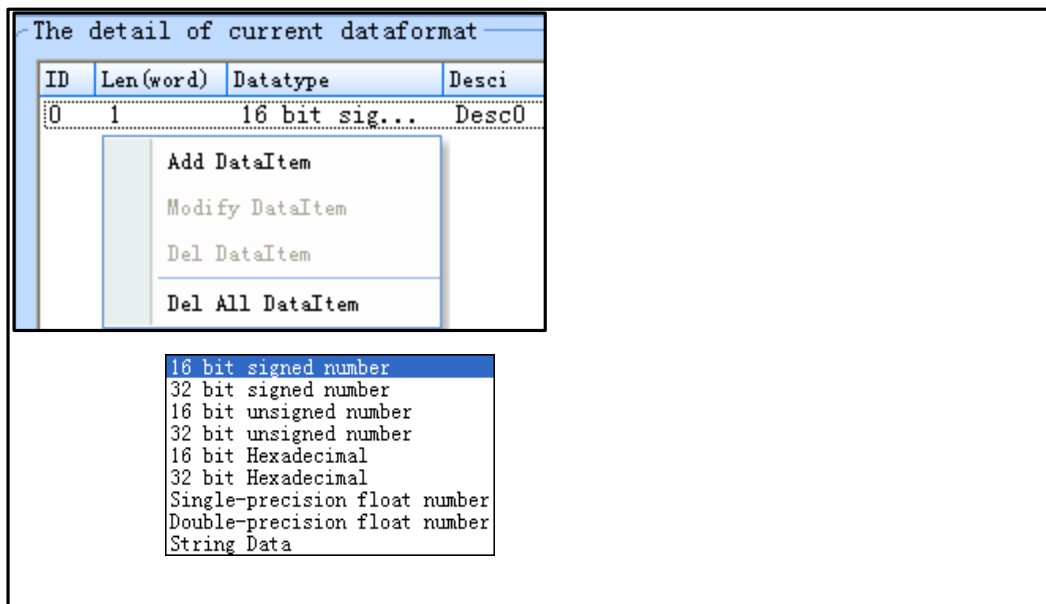

- Data Type can be [Single data] or [Array data].



In **【The detail of current dataformats】**, if each ID entry is a single data, data area address only corresponds to one column, if each ID entry is array data, and the array length is N, then the address of the data area corresponding N columns. If the [read address set area] is M, then the address of the data area corresponding to M lines. The entire data area of the format is M rows × (N0 + ... + Nx) columns, where Nx represents the x-th ID entry length of the array, if a single data, Nx = 1, if the array data, and the length of the array number N, the Nx = N

➤ Single data

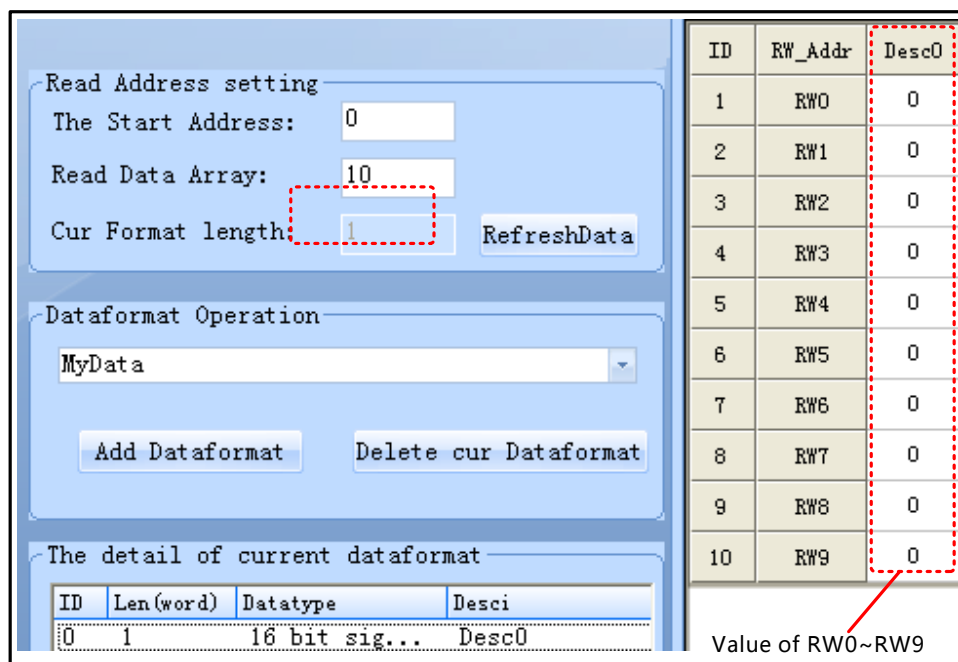

➤ Array data

Read Address setting
 The Start Address: 0
 Read Data Array: 10
 Cur Format length: 2 RefreshData

Dataformat Operation
 MyData
 Add Dataformat Delete cur Dataformat

The detail of current dataformat

ID	Len(word)	Datatype	Desci
0	1	16 bit sig...	Desc0

ID	RW_Addr	Desc0 (0)	Desc0 (1)
1	RW0	0	0
2	RW2	0	0
3	RW4	0	0
4	RW6	0	0
5	RW8	0	0
6	RW10	0	0
7	RW12	0	0
8	RW14	0	0
9	RW16	0	0
10	RW18	0	0

Value of RW0,2,4,6,8,10,12,14,16,18
 Value of RW1,3,5,7,9,11,13,15,17

- [String Data] support Unicode code type

Data Type Edit Dialog

Data Type
 Single data Array data

Description
 Desc1

DataItem type
 String Data
 Length 4 Unicode

Integer and Decimal
 Integer 1 Decimal 0

Codetype
 BIN BCD

Array len
 2

OK Cancel

(4) Adjustment of Data Start Address and Data Length

Read Address setting

The Start Address:

Read Data Array:

Cur Format length: RefreshData

(5) Save: Click  icon, and save the current data to recipe file.



After the completion of number modify, it would be click [save], otherwise the previous data will be lost after RefreshData button is pressed.

(6) Modify data item

The detail of current dataformat

ID	Len(word)	Datatype	Desci
0	1	16 bit sig...	Desc0

- Add DataItem
- Modify DataItem
- Del DataItem
- Del All DataItem

(7) File Merge

HMI can only download a recipe file every time. If you download the second recipe file will overwrite the first file. If you need to use a different recipe file, you can merge all recipe files to one file, then download the file to HMI.

- Create a 1.rcp file, default setting, and input 1~10.

Read Address setting

The Start Address:

Read Data Array:

Cur Format length: RefreshData

Dataformat Operation

MyData

Add Dataformat Delete cur Dataformat

The detail of current dataformat

ID	Len(word)	Datatype	Desci
0	1	16 bit sig...	Desc0

ID	RW_Addr	Desc0
1	RW0	0
2	RW1	0
3	RW2	0
4	RW3	0
5	RW4	0
6	RW5	0
7	RW6	0
8	RW7	0
9	RW8	0
10	RW9	0

- 20~29 Create a 2.rcp file, the start address: 20, and input 2~29.

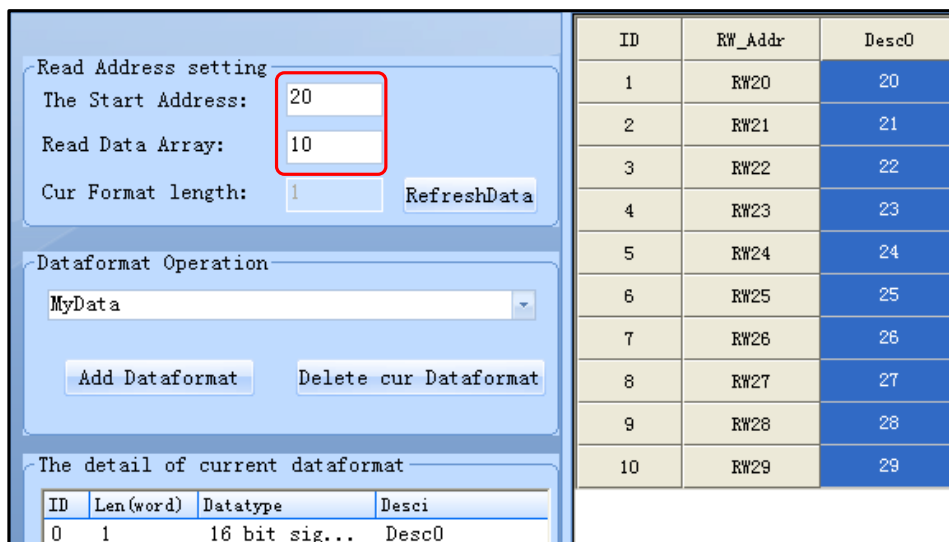

ID	RW_Addr	Desc0
1	RW20	20
2	RW21	21
3	RW22	22
4	RW23	23
5	RW24	24
6	RW25	25
7	RW26	26
8	RW27	27
9	RW28	28
10	RW29	29

- Merge 1.rcp and 2.rcp: Click [File Merge] menu-[File Merge].

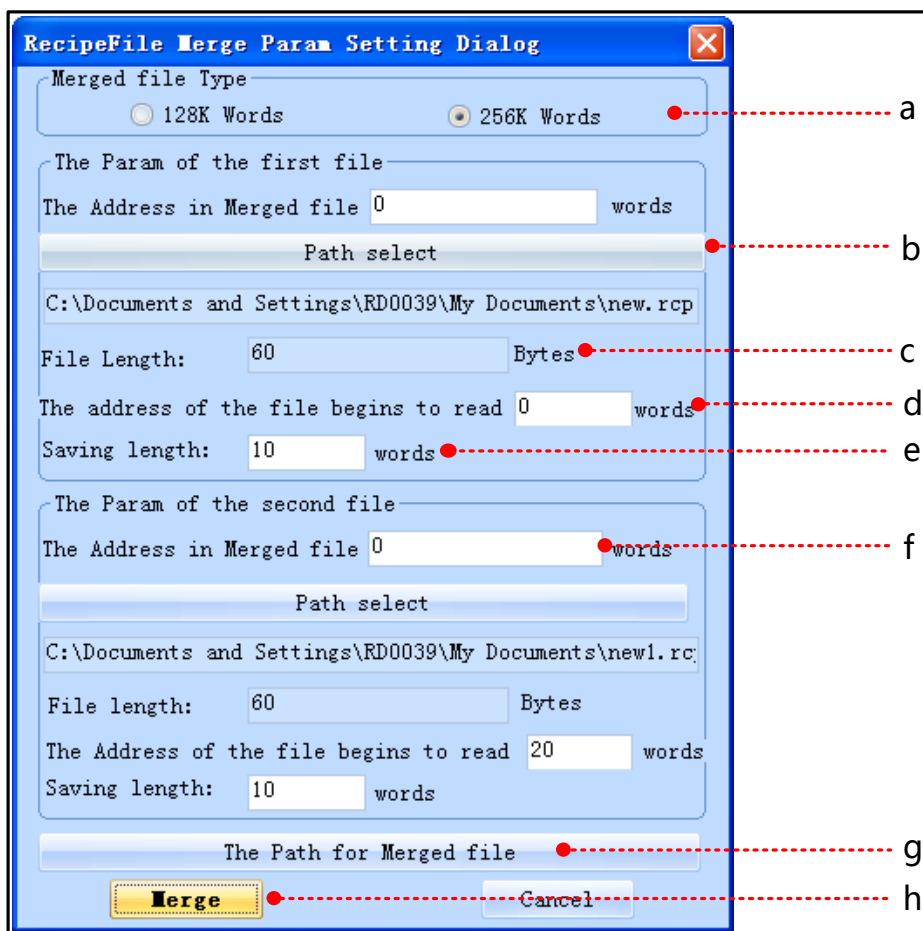

a: Select merged file type: The merged file will download to 128k words HMI or 256k words HMI.

The files size of merge depends on the file type after the merger, if it is 4000 series, then the size is 256KB, if it is 5000 series, then the size is 512KB. Note: The recipe size of MT4522T is 512KB, this time the file types after merger to choose 5000 Series.

b: Select the path: Select the file needed to merge.

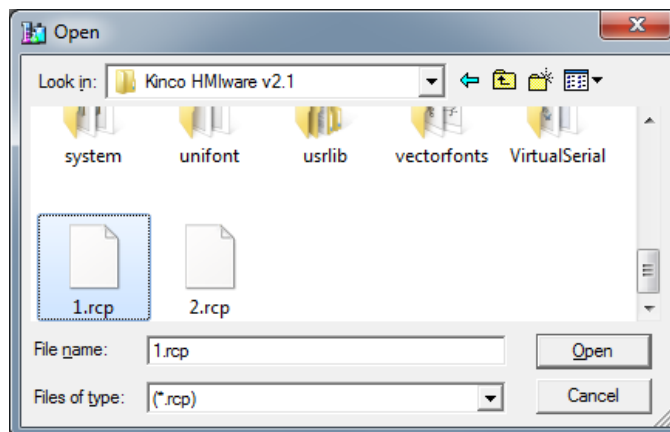

c: File Length: the size of merged file

[Example]: 1.rcp file is 20 bytes, then the file length is 20 Bytes.

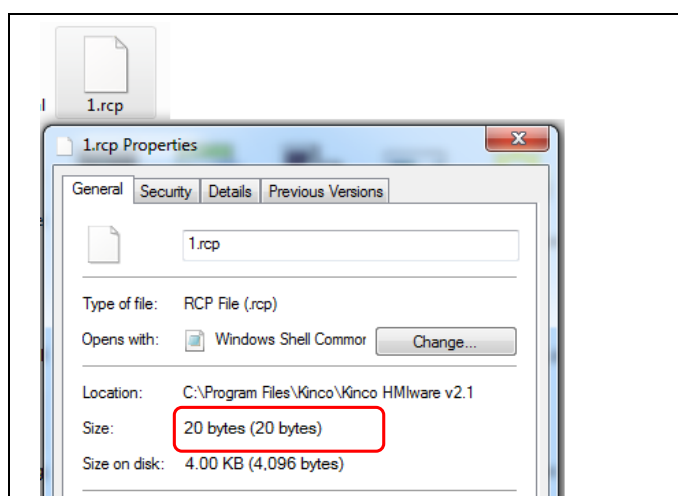

d: The address of the file begins to read: the starting address of recipe file.

[Example]: The starting address of 1.rcp file is 0, so [The Param of the first file] –[The Address in Merged file] is 0 words.

The starting address of 2.rcp file is 20, so [The Param of the second file] –[The Address in Merged file]: 20 words.

e: File length: the length of recipe file.

[Example]: the data type of 1.rcp and 2.rcp are single data, so the [The Param of the first file]/ [The Param of the second file]-[File length] is 10 words.

f: The Address of the file begins to read: The Address of the file begins to merge.

[Example]: The Starting address of the 1.rcp file is 0, so [The Param of the first file]-[The Address of the file begins to read] is 0 words. [File length] is 10 words, that is RW0~RW9.

The Starting address of the 2.rcp file is 20, so [The Param of the second file]-[The Address of the file begins to read] is 20 words. [File length] is 10 words, that is RW10~RW19.

So [The Param of the first file]-[The Address in merged file] is 0 words, [The Param of the second file]-[The Address merged file] is 10 words.



The Address merged file in the Param of the second file must be greater than the sum of the Address merged file and the Address of the file begins to read in the Param of the first file.

g: The path for merged file: Set the name and path for the merged recipe file.

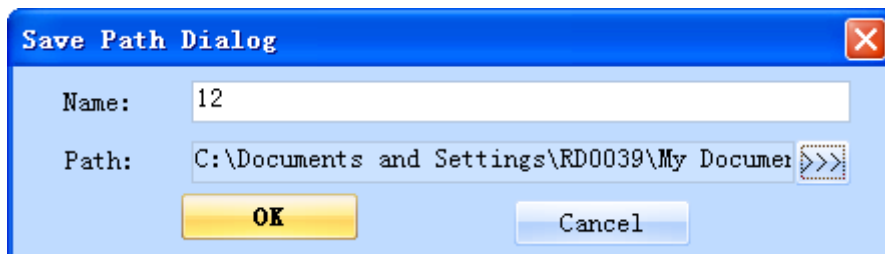

h: Merge file: Execute the [Merge file] operation.

The size of the 12.rcp merged file.

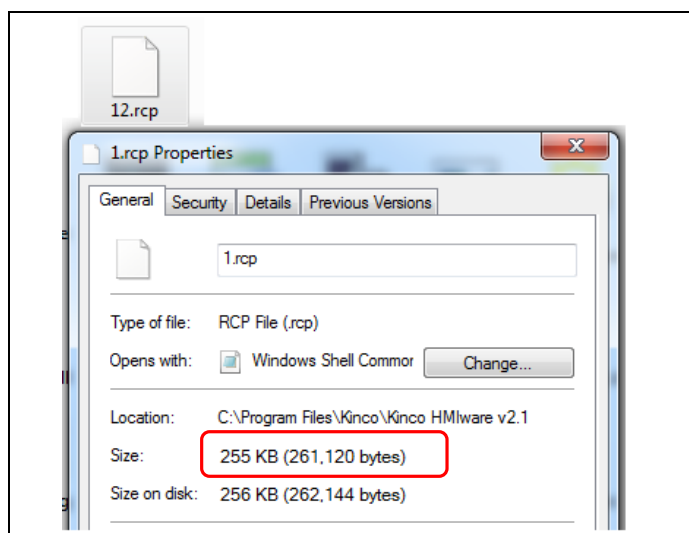

Open the 12.rcp merged file in RecipeEditor, and the data will display in [RecipeEditor] as below:

ID	RW_Addr	Desc0
1	RW0	1
2	RW1	2
3	RW2	3
4	RW3	4
5	RW4	5
6	RW5	6
7	RW6	7
8	RW7	8
9	RW8	9
10	RW9	10
11	RW10	20
12	RW11	21
13	RW12	22
14	RW13	23
15	RW14	24
16	RW15	25
17	RW16	26
18	RW17	27
19	RW18	28
20	RW19	29
21	RW20	0

11.5 Recipe Uploading/ Downloading/ Clearing

 For details about, refers to [Advanced Part 8 KHmanager]

12 KHMonitor

12.1 Descriptions of KHMonitor

KHMonitor is used to monitor the data in HMI and PLC registers through HMI.

12.2 Start KHMonitor

- Click **【Start】 - 【All Programs】 - 【Kinco】 - 【Kinco HMIware v2.1】 - 【Tools】 - 【KHMonitor】**
- In the installation directory of Kinco HMIware, double click **【KHMonitor.exe】**

12.3 KHMonitor Interface

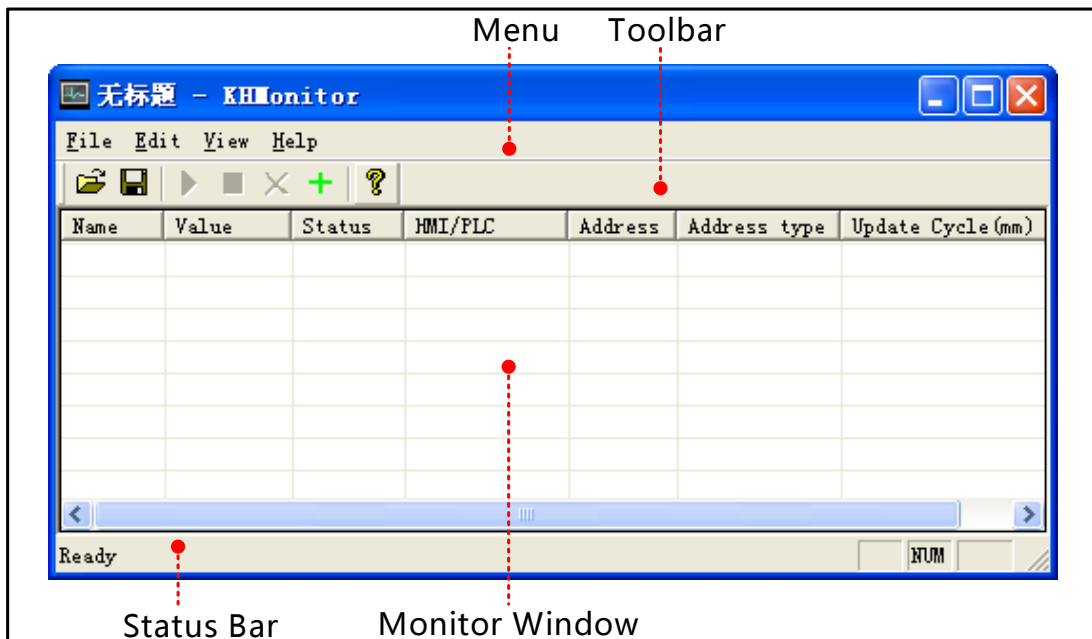

- Menu/Toolbar

Menu	Toolbar Icon	Toolbar	Description
File		Open	Open an exist monitor file
		Save	Save the monitor configuration file
		Save as	Save as another configuration file, its format is *.khm
		Exit	Close KHMonitor
Edit		Select All	Select all the monitor items in monitor window
		Add	Add a monitor item
		Del	Delete the selected monitor item
		Run	Execute selected monitor register
View		Stop	Stop the status of selected monitor register
		Toolbar	Open/Close Toolbar
		Status Bar	Open/Close status bar

Help		About KHMonitor	Version information
------	--	-----------------	---------------------

- Monitor Window
- Monitor Window is used to display information such as Name, Value, Status, HMI/PLC, Address, Address type, Update Cycle (ms).



Double click the monitor item in Monitor Window to change its setting.

12.4 How to Use KHMonitor

- 1) Create new monitor item: When it is first time to use KHMonitor, click in toolbar to create data monitor.
 - 2) Enter monitor name: Enter monitor name in the popup window when creating new monitor. Default name is New Monitor0, if create another item, the No. will increase automatically.
 - 3) Set Communication Type: Set the current connection type between HMI and PC.
- Set Communication Type as following figure:

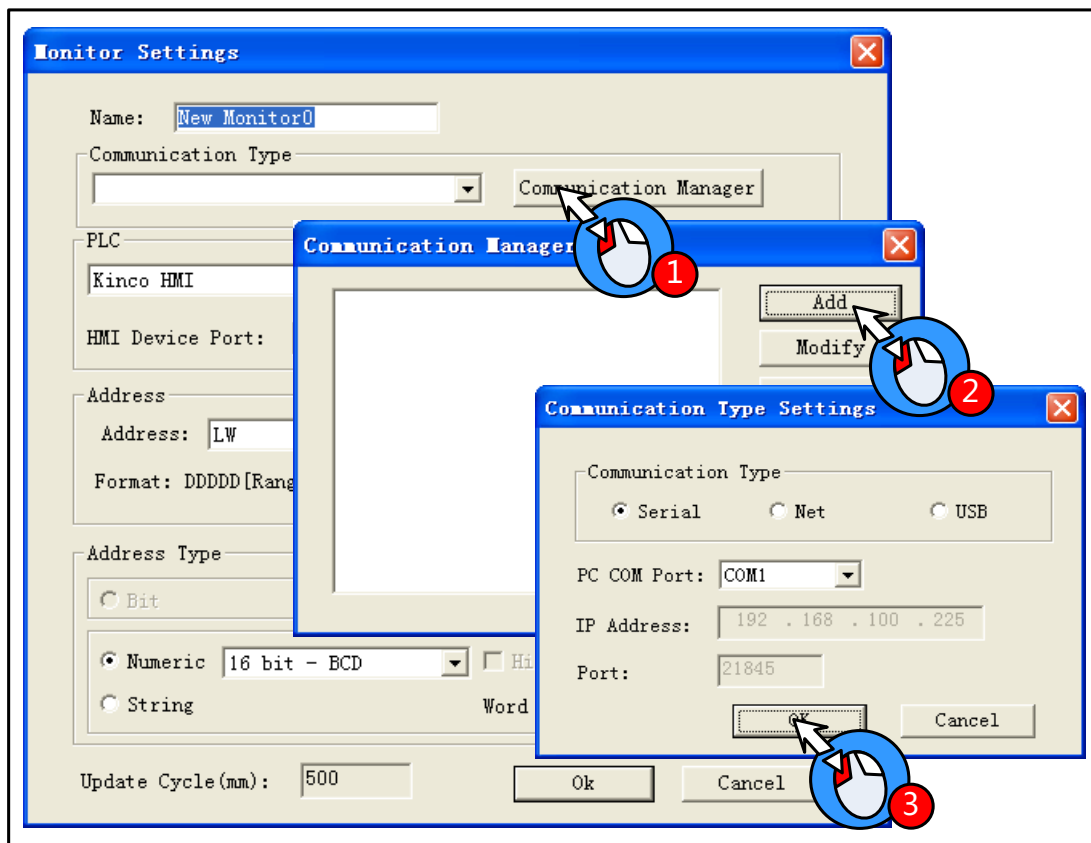

● Communication Manager include function such as **【Add】** , **【Modify】** , **【Remove】** , **【Remove all】** , **【OK】**

- Add: to add a new communication type between HMI and PLC.
- Modify: to modify the current communication type.
- Remove: to remove the selected communication type.
- Remove all: to remove all the communication

● Descriptions of Communication Type Settings.

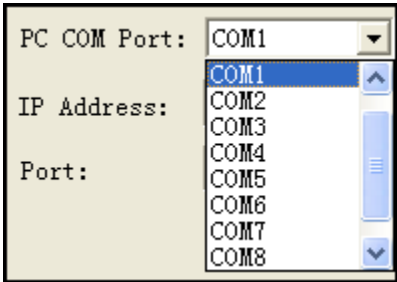
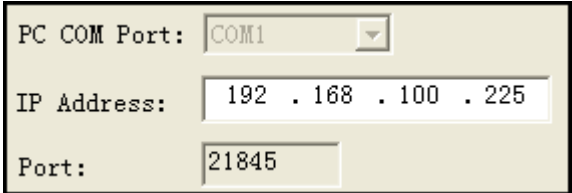
Communication Type		Parameters Setting
Serial	<input checked="" type="radio"/> Serial	Select current HMI COM port. 
Ethernet	<input checked="" type="radio"/> Net	Set current HMI IP. 
USB	<input checked="" type="radio"/> USB	No need to set parameters.

4) PLC: to select the communication protocol between HMI and PLC.

Descriptions of 【PLC】	
Drop down menu for PLC	Select the corresponding communication protocol between HMI and PLC.
Station	PLC's station No.
HMI Device Port	Select the HMI port which is used to communicate with PLC

5) Address: to set the address which needs to be monitored

Descriptions of 【Address】		
Address	Set the address of HMI/PLC which needs to be monitored	
Batch	Batch Count	Set the number of address which will be copied, its range is 1~1000
	Address Auto Change Mode	Copy by address increment/decrement.
	Forward Address Auto Change	Increment/decrement for the address of the register
	After Address Auto Change	Increment/decrement for the address of the register in accordance with the decimal point
Note: Batch is only valid in the first time to add monitor items.		

6) Address Type: to select the data type of the address, including bit, number and string. It will display the data according to selected data type when monitoring.

7) Run/Stop monitor

【Run】: Select monitor item and click  icon in toolbar to run it. Press ctrl/shift icon to select more items. The data will display in “Value” after run the item.

【Stop】 : Select monitor item and click  icon in toolbar to stop it. Press ctrl/shift to select more items.

13 Print

Kinco HMIware support 2 type of printing method :

- Local print: Printing via serial or USB interface, HMI is connected directly to the printer to print the HMI screen.



- Network print (remote print): Through network printer to print HMI screen.

Network printing needs hardware configuration: HMI with Ethernet port and connect to the LAN, the LAN with a PC, printer, and the printer is no direct link between the HMI, and HMI does not need any drivers.



13.1 Type of Printer supports local printing

Kinco HMIware supported printer models as follows:

Kinco HMIware Printer Driver	Printer Models	Printer Interface	Printer method	Dot Matrix	Manufacturer information
WH4008A31-0 53	WH-A52Z20-30E125	Serial	Pin micro-printing	240 pixels / line	
	WH-A52Z20-40E125	Serial	Pin micro-printing	240 pixels / line	
WH-A62R10	WH-A62R10-41E725	Serial	Thermal micro-printing	192 pixels / line	
	WH-A93RG0-00E725	Serial	Thermal micro-printing	192 pixels / line	
	WH-E173R90-00E11720 GA	Serial	Thermal micro-printing	192 pixels / line	
WH-A93RG0-0 0E825	WH-A93RG0-00E825	Serial	Thermal micro-printing	384 pixels / line	
	WH-T2AR10-30E82B	Serial	Thermal POS	384 pixels / line	
WH-E191RB0- 00E1182055	WH-E191RB0-00E11820 55	Serial	Thermal micro-printing	576 pixels / line	
Siupo SP-M, D, E, F	SP-E4004SK	Serial	Impact dot matrix	240 pixels / line	
MY-POS80K	MY-POS80K	Serial	Thermal POS	240 pixels / line	

13.2 Printing-related Components

In Kinco HMIware, you can use the print function of specific components as follows:

Components name	Trigger Register	Print Content	Support	Support Network
			Local Print	Print
Function Key	—	Print Current Screen	<input type="radio"/>	<input type="radio"/>
PLC Control (Report Printout)	Word	Print the specified screen	<input type="radio"/>	<input type="radio"/>
PLC Control (Screen Hard Copy)	Bit	Print Current Screen	<input type="radio"/>	<input type="radio"/>
Event Information Logon	Word / Bit	Print the contents of trigger event	<input type="radio"/>	<input type="radio"/>
Trend Curve	Word / Bit	Print trend curve	<input type="radio"/>	<input type="radio"/>

 [For more details about the print-related elements settings, please refer to \[Advanced Part 4 Component\]](#)

- Report Printout

You control the specified window screen printout by changing the value of the specified word registers. When the value of the specified register word changed, and is a valid window number, the window number corresponding window contents will be printed. Printing is completed; the value of the specified register address automatically changes to 0.

Example: Set as shown below, when the value of LW0 is equal to 10, print the contents of the window 10. Printing is completed, the value of LW0 automatically change to 0. When the value of LW0 is equal to 11, print the contents of the window 11. [Report] function using output only execute print function does not perform the function of switching window, will not switch to the print window. Using the [Report Printout] function performs only print function and will not switch to the printed window.

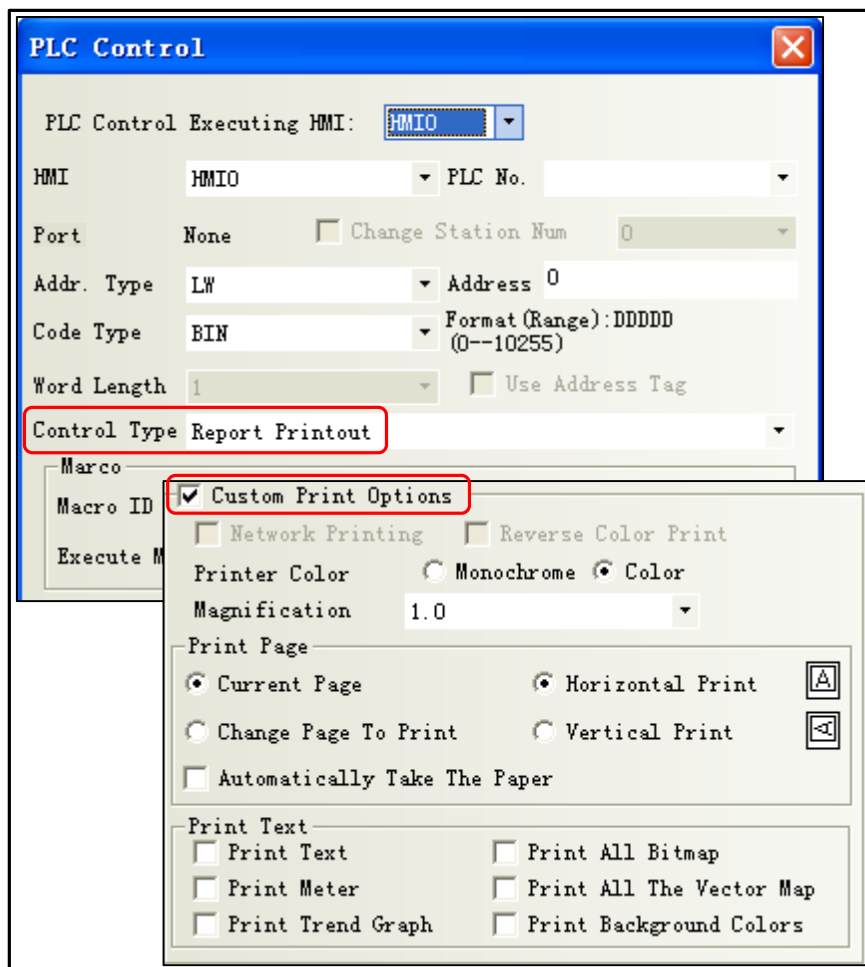

- Event Print

In the [Event Information Logon], set the print log events, when the set condition is triggered, it will print out the event contents.

Example: Set as shown below, selecting [On Trigger] and [Return to Normal]: when LBO is ON, print "temperature is too high!" When LBO returns to OFF, print "Temperature is too high!".

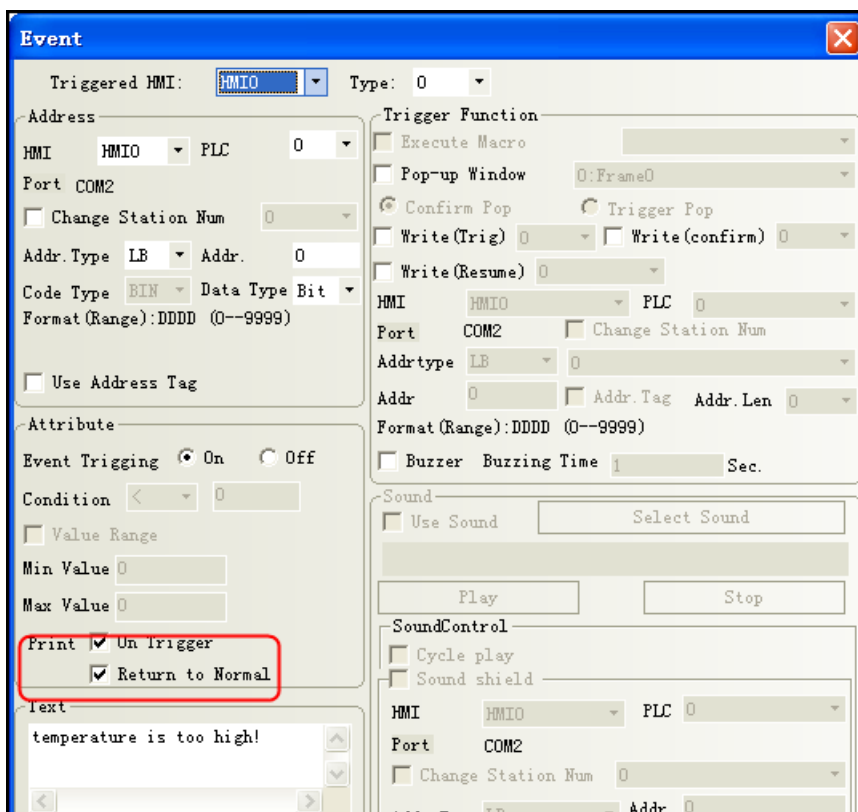

If you need to print the time, check the contents in [HMI Attribute] - [Print Settings] - [Print Settings of Event Display].

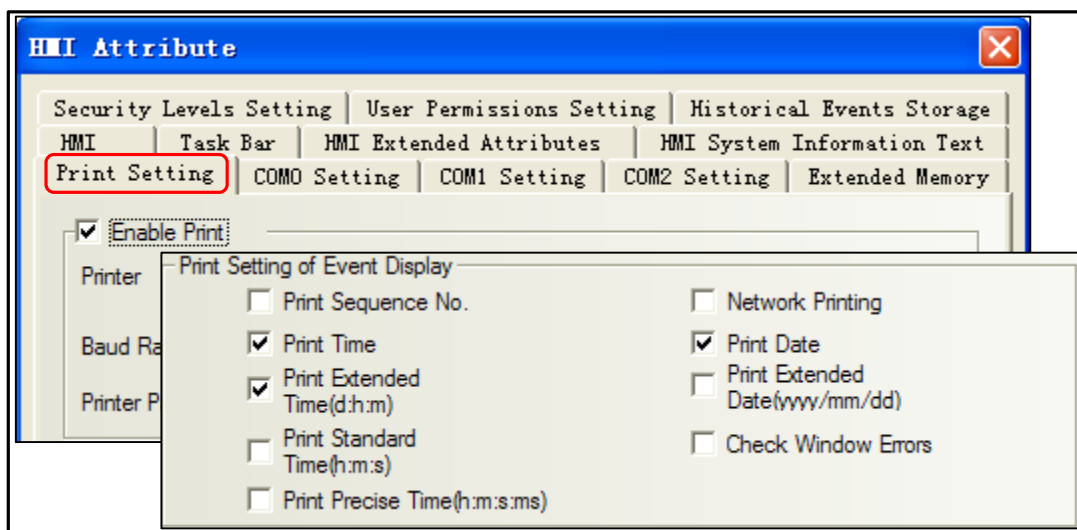

[For more details about Print Settings of Event Display, please refer to \[Advanced part 6.1.8 Print Setting\]](#)



[Print] - check the [Print Relative Time], if no printer is connected, HMI will be prompted to an error message "Print Error"

[For more details about \[Trend Print\], please refer to \[Advanced Part 4.6.1 Trend Curve\]](#)

13.3 Pictbridge Print

Pictbridge is a direct connection and picture printing standard, the devices which support this protocol can be connected

together and print pictures directly. In Kinco HMIware V2.2, customer can use Pictbridge to connect HMI directly with printer and print the screen directly. This standard supports connecting devices to printer directly but do not need to connect the device to PC to print, it is very convenient for different applications.

MT4000 serial HMI supports all the printers which support PictBridge protocol, user can connect HMI and this printer with USB cable on HMI USB slave port. Then they can print HMI screen and data on this printer.



1. MT4210T、MT4220TE、MT4310C、MT4300C、MT4300CE、MT4403T\TE、MT4512T\TE、MT4523T\TE、MT4404T、MT4424TE、MT4522T\TE、MT4620TE, MT4414T\TE, MT4513T\TE. The HMI which are produced after Dec 2013 support Pictbridge printing.
2. MT4210T、MT4220TE、MT4310C、MT4300C、MT4300CE、MT4403T\TE、MT4512T\TE、MT4523T\TE, MT4404T, MT4424TE、MT4522T\TE、MT4620TE, MT4414T\TE ,MT4513T\TE. The HMI which are produced before Dec 2013 will support Pictbridge printing after updated the kernel and rootfs in Kinco HMIware v2.2 (build131108) .
3. Kinco HMIware v2.2 (build131108) or higher version supports Pictbridge printing

When user downloads program from Kinco HMIware or U disk to HMI, if there is information of “Please update Kernel and Rootfs”, which means user needs to update the Kernel and Rootfs.

Version Information:

Kinco HMIware Version	Kernel	Roots	Need to update or not	Enable PictBridge
V2.1(build130805)	1828	1895	Yes	Do not support
V2.2(build131108)	1958	1971	No	Support

If customer does not need the print function in Kinco HMIware V2.2, please disable the “Enable Pint” in HMI Print

Setting and then compile the program again before downloading

Flow chart of update printing function

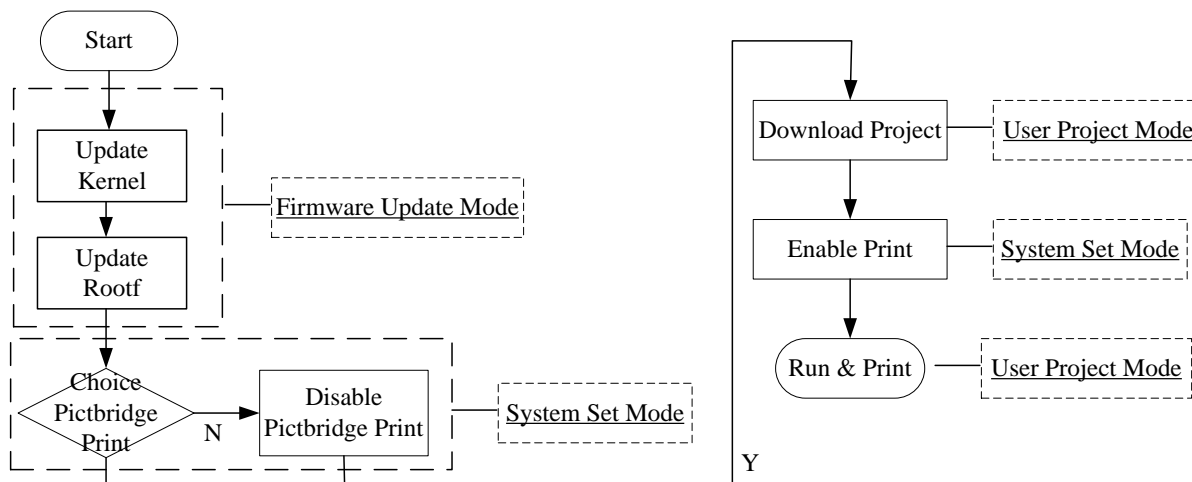

Different modes of HMI USB slave port.

Setting Items		Enable Print in HMI Attribute in Kinco HMIware	
		Checked	Unchecked
Enable Printer Function in HMI Setup Window	Checked	Print Mode, can print from USB slave port, but cannot download program.	Print Mode, but cannot print from USB slave port, because there is no compiled files for printing.
	Unchecked	Download Mode, cannot print	Download Mode, cannot print

To sum up, user must check the Enable Printer Function in setup window and Enable Print in Kinco HMIware to enable the print function in HMI.

13.4 Print Function Setting Method

13.4.1 Local Print: HMI serial is connected directly to the Printer

[Example 1] MT5320T connect to WH-A93RG0-00E825 printer, print the current screen by function key. First create a new project.

- 1 Enable Print and select Printer driver: [HMI Attribute]-[Print Setting]-[Enable Print]

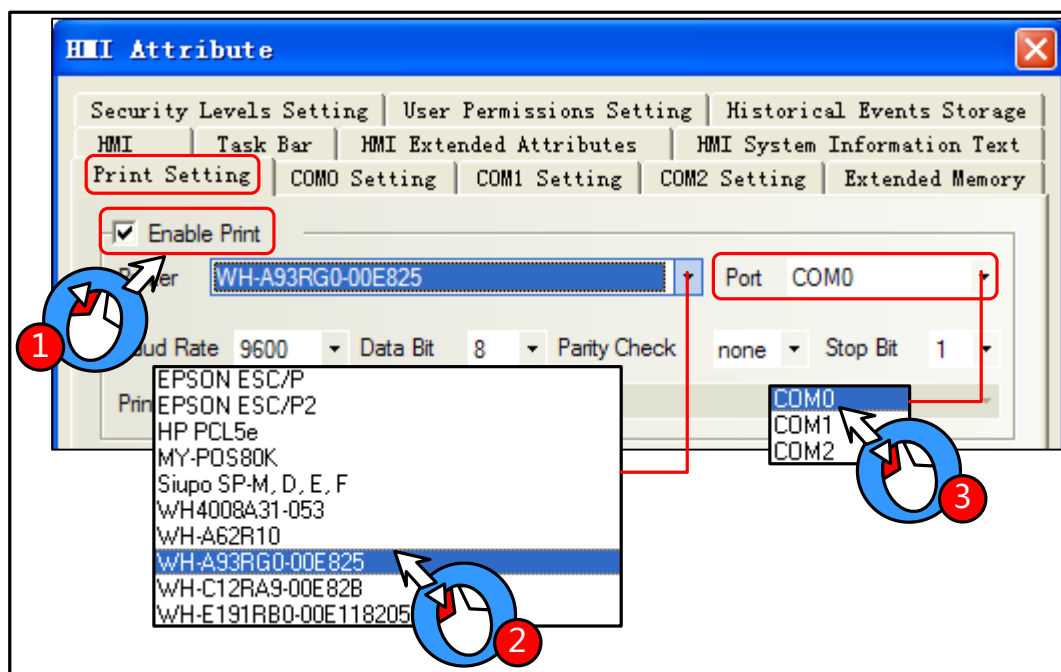

- 2 Select the printer driver "WH-A93RG0-00E825" from the [Printer] list.
- 3 Select the printer port connected with HMI, in this case choose "COM0".



Same port cannot be set to print port and communication port

- 4 [Baud rate / data bits / parity / stop bits] recommend using the default settings, and printer parameters must be consistent. In this case [baud] / [data bits] / [Parity] / [stop bits] are the default.
- 5 You place a function key on screen0, and select [Print] - select All [Print Text]. Compile and download to HMI.

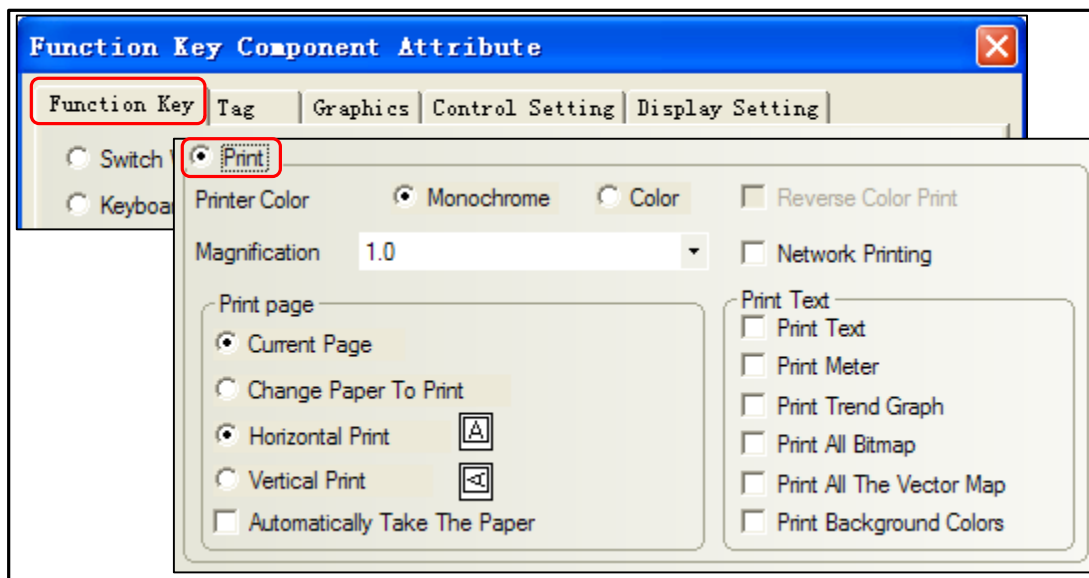

The COM0 wiring connection instructions about WH-A93RG0-00E825 printer and MT5320T, please refer to [Communication Manual]

- ⑥ Through press the function key to print current screen.



Because micro-printer are monochrome printers, when editing HMI configuration project, recommended window fill color is white, the text color is black, try not to use the color pictures, so as to avoid the printing effect is not clear

13.4.2 Local Print: HMI USB Slave is connected directly to the Printer

Example of how to use PictBridge function:

1. Enable the “Enable Print” in Print Setting of HMI Attributes. Choose the PictBridge as the Printer.。

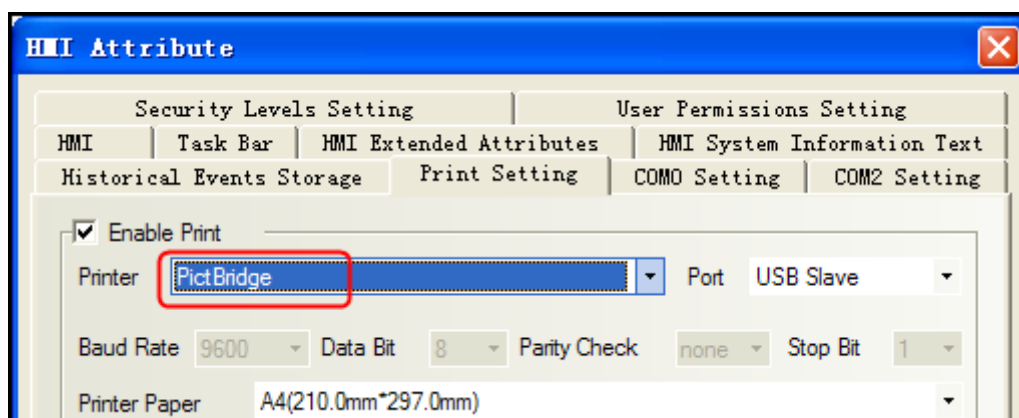

2. Set the small dip switches SW1 and SW2 to ON then restart, HMI will display the set up screen, check the “Enable Printer Function” to enable the printing protocol

Enable Printer Function in set up screen:

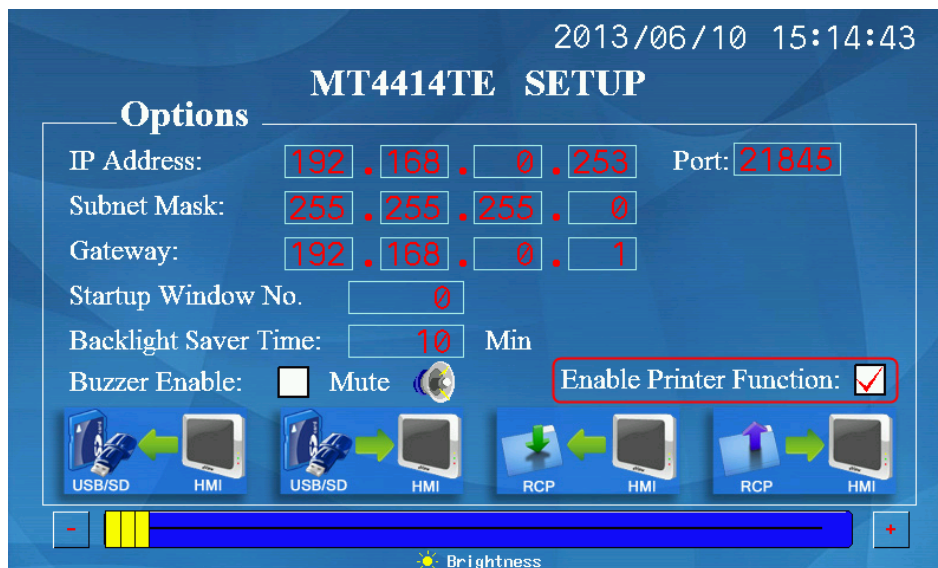

3. Set the DIP switches SW1 and SW2 to OFF then restart, HMI display the normal operation screen.
4. Use USB cable to connect HMI (USB Slave) to printer to print HMI screen and data.



- a) The USB slave port on HMI is used to download/upload program in default setting, if click the “**Enable Printer Function**” in HMI setup screen, the USB port is configured as printing port, It does not support program download/upload or other functions in this mode.
- b) In rewrite Kernel and Rootfs mode (SW1 ON, SW2 OFF and restart), the USB slave port is always configured as download mode, the above setting can not affect this function in this mode.
- c) The printer may not work normally after HMI is repowered or restarted, please restart the printer if this problem happens.

13.4.3 Network Print (remote print): Through Network Printer to Print HMI Screen.

Element to enable network printing setup method as follows:

Components name	Trigger Register	Print Content	Enable Network print
Function Key	—	Print Current Screen	
PLC Control (Report Printout)	Word	Print the specified screen	
PLC Control (Screen Hard Copy)	Bit	Print Current Screen	

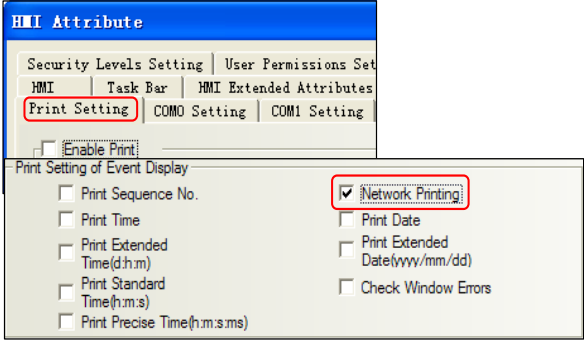
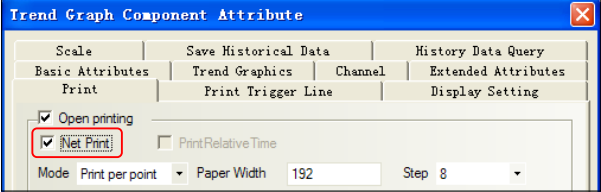
<p>Event Information Logon</p>	<p>Word/ Bit</p>	<p>Print the contents of trigger event</p>	
<p>rend Curve</p>	<p>Word</p>	<p>Print trend curve</p>	

[Example]: requirements through remote printer to print the HMI Screens.

Preparation before printing: a PC, a HMI with network interface, a printer can be directly connected to the PC

This example uses the HP USB printer which model is HP LaserJet P2014, HMI model is MT5320T, and use the [PLC Control] - [Report Printout] function to print the specified screen.

- 1 Installed printer driver on the PC, then in the operating system [Control Panel] - [Printers and Faxes] to find the appropriate printer, and through the right-click menu to set as the default printer



- 2 Run the print program on PC **【NetPrint.exe】**

[NetPrint.exe] program is stored in Kinco HMIware software installation directory, if the user did not change the installation directory, the default installation path is **【D:\Program Files\Kinco\Kinco HMIware】**.

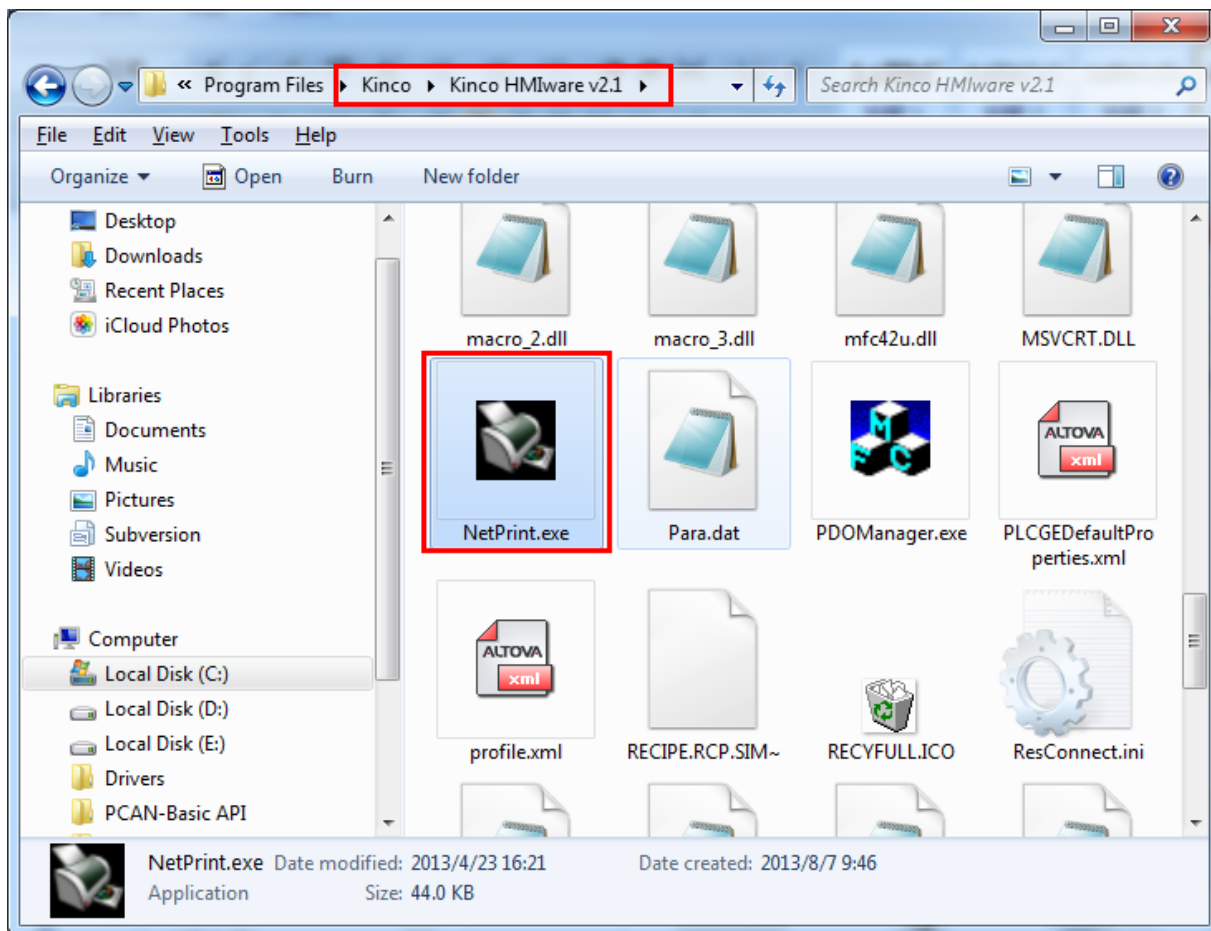

Double click to run [NetPrint.exe], if the firewall prompts [you want to keep this process?], Select [Unblock].



When printing, [NetPrint.exe] need to keep running, [NetPrint.exe] during operation will be minimized to the tray

3 In the [HMI Attribute] - [Print Settings], set the PC IP address and port which run [NetPrint.exe]:

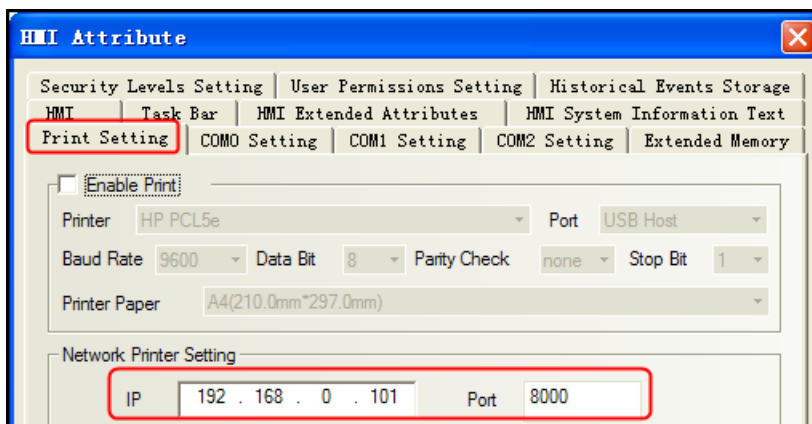

4 In the [HMI Attribute]-[HMI], set the HMI IP address

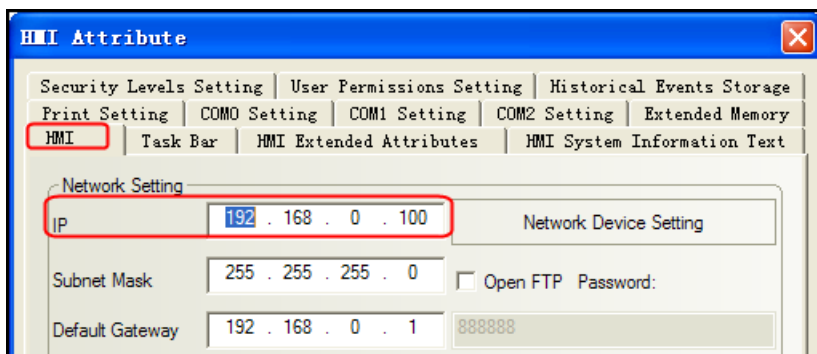

1. The PC which connect to the printer and the PC which run the [NetPrint.exe] program can be the same, and it can also be any PC within the LAN
2. The PC which connect the printer, the PC which run the [NetPrint.exe] program and HMI are connected to the same LAN, IP address must be on the same subnet, IP address must be the same in front of three, the last one is not the same

⑤ Enable network printing

PLC Control] property in the [[control type] is set to "Report Output" to specify the address of the register LW0; then check [custom printing options]] and [network printing and check all the options] [print content.

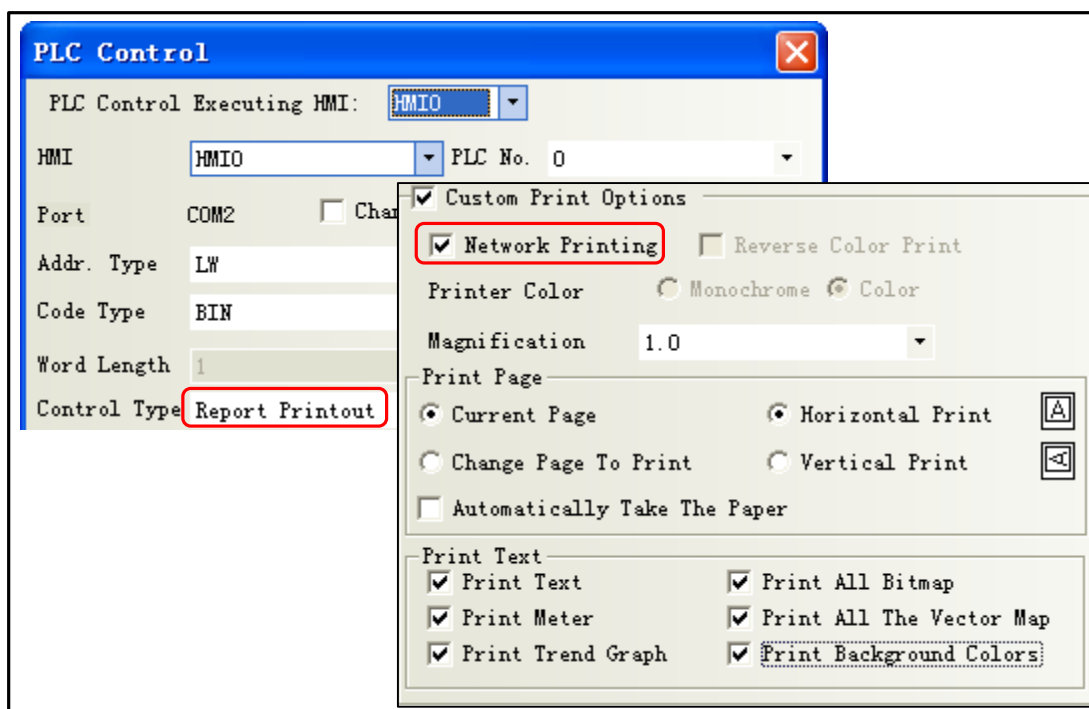

And then you place a "Numeric Input" component on screen 0. [Read / Write Address] is set LW0. Save and compiled, then downloaded to HMI.



1. Use [network printing] function, you need to enable the print function in related components, while local print only need to enable print function in [HMI attribute]-[Print setting]
2. Select the [Network Printing], printer color cannot be modified, the default is monochrome

6 Cable

The HMI through cross or direct network cable access network.

7 Setting print properties

Click [NetPrint.exe] icon to pop up the properties window. As shown:

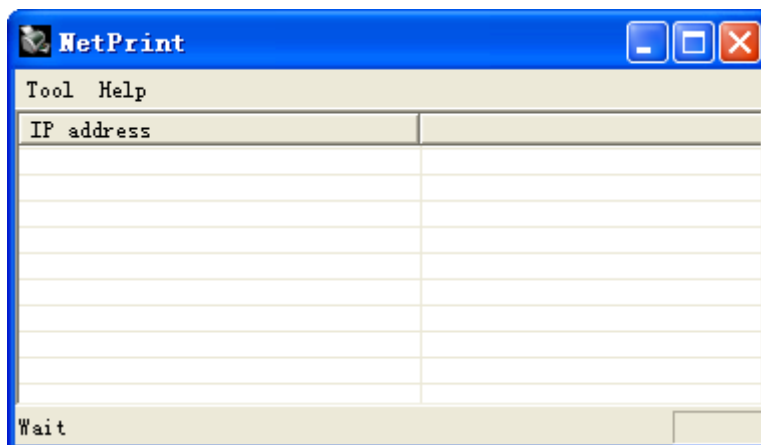

Property described as follows:

NetPrint property descriptions			
Tool	Print Setup		
		Paper Direction	set portrait/landscape
		Print Position	set align left/mediate
		Print Method	[alone]:Printers print in real time, immediately upon receiving the print job Print [merge]: After receiving the print job is not printed immediately, but covered with a total content of paper to print the print job again, this function is mainly used to save paper

	Save to local	Checked, and choose the path, upon receiving the print job, you can save the screen pictures on your PC instead of printing. Picture format. JPG, picture naming names is the time, yyyyymmdd-hhmmss, such as 20120903-110552.jpg
	Printer Setup	
Print Preview	View print effect	
Exit	Exit [NetPrint.exe]	
Help	About [NetPrint.exe] version information	
IP address	HMI IP address. If the HMI with the PC connected to the same LAN, NetPrint will automatically detect	

⑧ Change on the value of LW0, it will print the contents of the corresponding window

13.4 Print Page Application Skills

When the HMI window larger or smaller than the actual width of print paper, you can set the current window to **【Print Page】**, by changing the HMI window width and height to achieve print paper more or less than the actual width of the HMI window. This feature is only available for [Report printout]



1. Select [Print page], the window maximum width and height can be set to 1024 x 1024 pixels / line.
2. Once the height of the window is set to exceed the actual height of the HMI window, if the HMI runs the window, over the part will not show up. Recommended to use [Report printout], that only need to print this window, no view on the HMI. If you want to view, you can do a normal screen identical to the user.

[Example] HMI model: MT5320T, the width of window is 320 pixels / line.

WH-A62R10-41E725 printer support 192 pixels / line.

If MT5320T connect to WH-A62R10-41E725, the HMI is wider than the width of the paper, so the window to the right of HMI 128 pixels printed out.

① Create a new project of MT5320T

② [HMI Attribute]—[Print Setting]—select[Enable Print].

[Printer]: WH-A62R10

[Port]:COM0

[Baud Rate]/ [Data Bit]/ [Parity Check]/ [Stop Bit] are default.

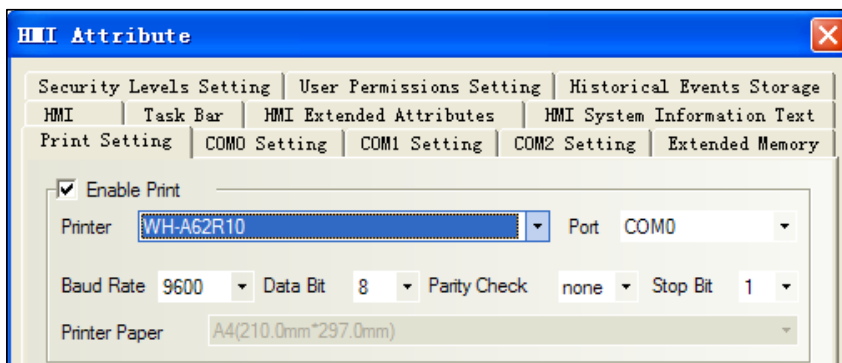

③ Double-click screen0 , [Window Attribute]-choose [special attribute]-[print page], and set the width is 192, height is 1024.

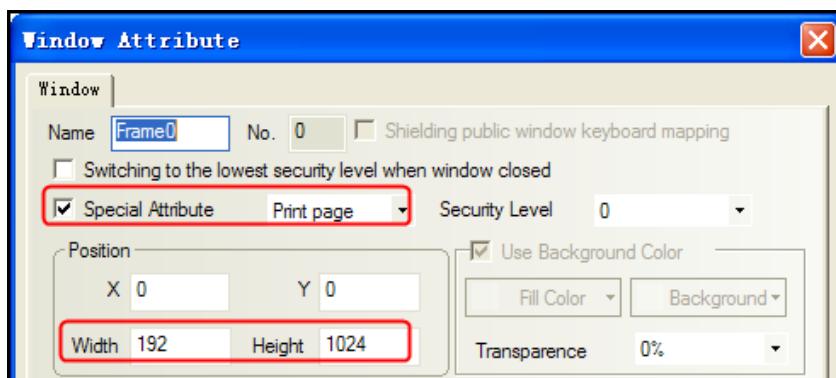

④ Set control type: [Report printout]

[For more detail about \[Report printout\], please refer to \[Advanced part 4.15.5 PLC Control\]](#)

⑤ Cable



For more details about the printer connection cable, refer to [communication connection Manual]

13.5 Print Error

The following dialog box will be displayed when the printer error:



When this error occurs, please check the printer power, cable, printer port, etc. are normal.

[For more details about shielding print error messages and modify the print error information content, please refer to \[Advanced part 6.1.4 HMI System Information Text\]](#)

14 HMI Communication

This chapter introduces the HMI supports communication and various communication configurations.

14.1 Serial Communication

Serial interface that is referred to is a bit of data sent in the order. Serial communication is common in industrial control communication, which is characterized by a communication line as simple as a pair of transmission line can be two-way communication, thereby reducing costs, especially for long-distance communication, the communication distance can be from a few meters to several thousand m, the transfer speed is slow.

HMI supports RS-232C, RS-485, and RS-422A three kinds of serial communication connection.

14.1.1 HMI and PC Serial Communication

HMI via RS-232C serial cable to connect the PC side serial interface for user projects, recipes and other data upload / download and HMI firmware update.

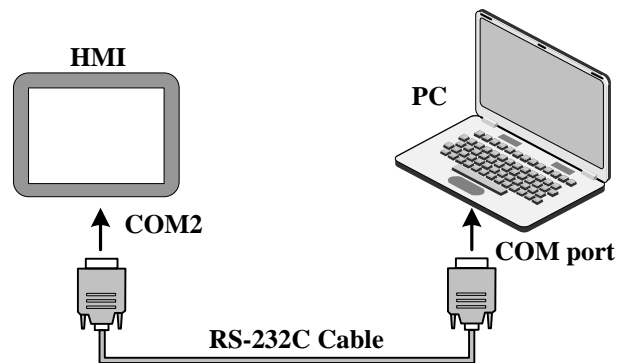

[For more details about uploading and downloading via the serial port on the HMI, please refer to \[Advanced Part 8 KHManager\]](#)

14.1.2 HMI and PLC /Controller Serial Communication

Single HMI via the serial port with single PLC communication, but also support multiple serial communication protocol to use the same or a different serial communication protocols PLC / controller communication.

In the same COM port, can connect multiple serial communication protocol and uses the same multi-point communication PLC / controller can connect up to 255 devices. The serial communication protocols using different PLC / controller needs were connected to the HMI different COM port, and can simultaneously and use three different serial communication protocols PLC / controller communications, depending on the hardware configuration of the actual HMI decision.



COM0 and COM1 port supports RS485 interface mode, respectively simultaneously with multiple serial communication protocol to use the same PLC / controller communication; The RS232 interface COM2 port supports only way, it does not support multiple PLC / controller communication

- single HMI with a single PLC / controller communication

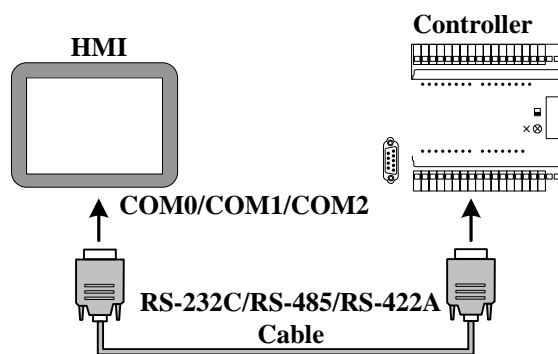

[Example] Below a MT5320T with a SIEMENS S7-200 communication, for example, requires the HMI monitor PLC M0.0 output state. (This example uses the HMI COM0 port to connect PLC communication)

- 1 Configure the device in the topology window and set the communication parameters

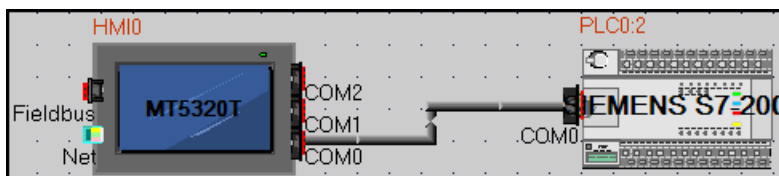

Configuring HMI COM0 client communications parameters: [HMI Attribute]-[COM0 Setting] set the serial communication parameters

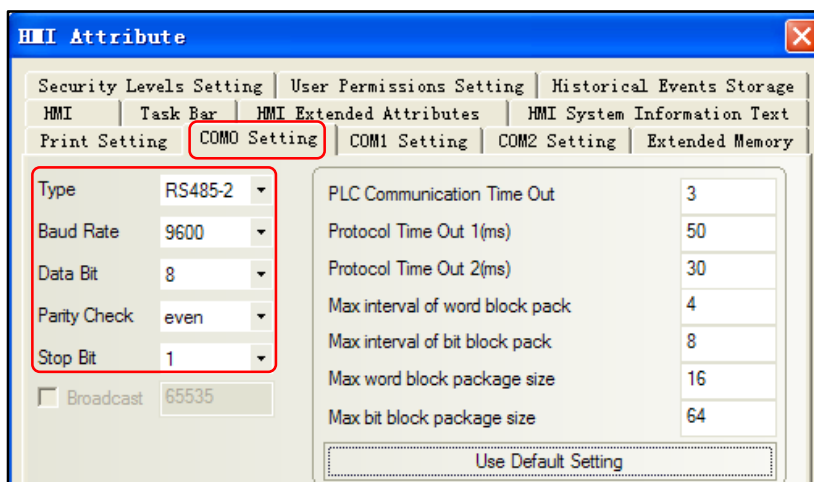

HMI serial communication parameters with the actual PLC communication port parameters consistent

Configure the PLC station number: [PLC Attribute] – [station NO.] setting 2

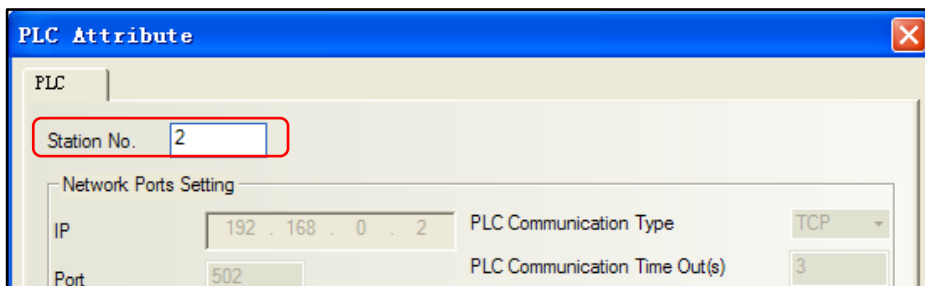

[PLC Attribute] – [station NO.] consistent with the actual PLC station number

2 Edit the configuration screen

Double-click the HMI in the topology window icon to open the Configuration Editor window, From the [Graph Element window] - [PLC Parts], select "Bit State Lamp" component added to the Configuration Editor window, and set the component Attribute are:

Read Address	M.B 0.0 (PLC Register)
Graph	<div style="display: flex; justify-content: space-around; align-items: center;"> State0 State1 </div> <div style="display: flex; justify-content: center; align-items: center; gap: 20px;"> </div> <p>Using vector graphics,</p>

After setting, save the project, compile and download.

3 Using RS-485 communication cable for connecting the HMI and the PLC, After successful communication can be established on the HMI monitor the state of M0.0

- single HMI with multiple PLC / controller communication
 - Single HMI with multiple PLC / controller (different communication protocols) communication

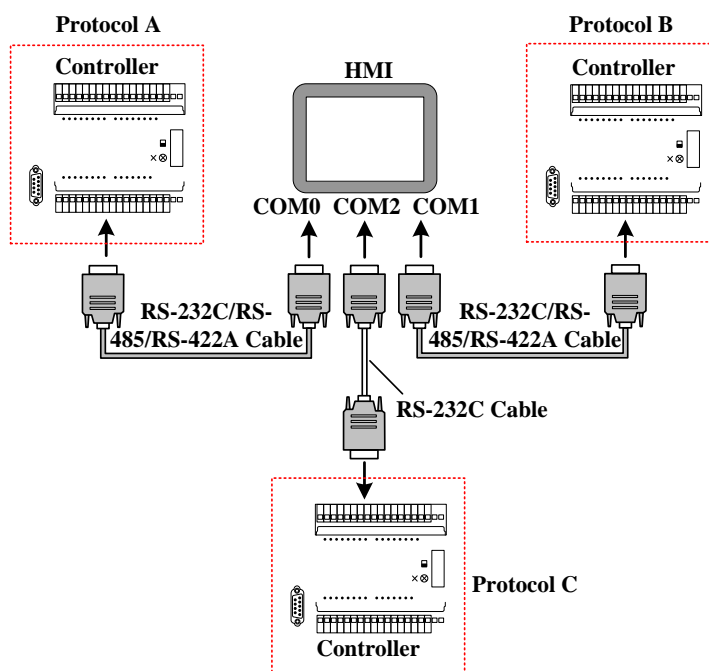

[Example] Below a MT5320T with a SIEMENS S7-200 (hereinafter referred to as PLC 0), a MITSUBISHI FX2N (hereinafter referred to as PLC 1), a OMRON CP1H (hereinafter referred to as PLC 2) communication, for example, Requirements were monitored on the HMI PLC 0 of VW 100, PLC 1 of D100 data and PLC 2 in Q 0.0 outputs.

(This example uses the HMI COM0 port to connect PLC 0, COM1 connected PLC 1, COM2 communication connection PLC 2)

- 1 Configure the device in the topology window and set the communication parameters

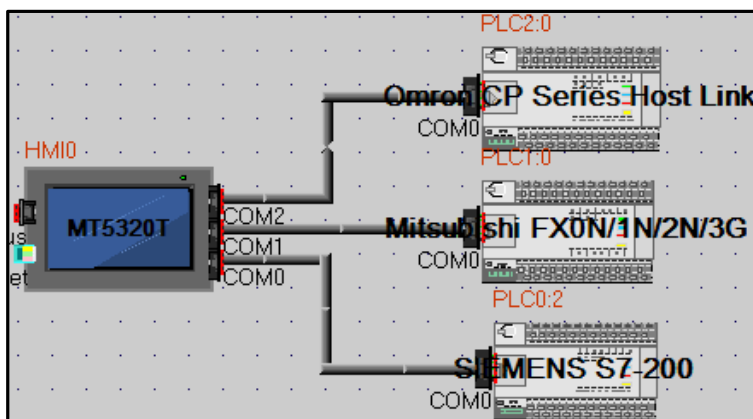

In the [HMI Attribute] - [COM0/COM1/COM2 Setting] According to the serial communications port of the connected PLC actual parameters were set to HMI serial communication parameters, Parameters are set as follows:

HMI serial	Serial communication parameters
COM0	RS485-2, 9600, 8, Even parity, 1
COM1	RS485-4, 9600, 7, Even parity, 1
COM2	RS232, 9600, 7, Even parity, 2

In the PLC 0, PLC 1, and PLC 2 [PLC Attribute], in accordance with the actual [PLC station number] to each station number setting:

PLC Number	Station number
PLC 0	2
PLC 1	0
PLC 2	0



Connected to the serial port on a different HMI PLC / controller can be set to the same or a different station number, setting the station number to be connected with the actual PLC / controller station number the same.

- 2 Edit the configuration screen

Double-click the HMI in the topology window icon to open the Configuration Editor window, Respectively, from the [Graph

Element window] - [PLC Parts] select two "Number Display" and a "Bit State Lamp" component added to the Configuration Editor window, Component Attribute are set to:

Number display element _1

PLC Number*	0
Read Address	VW 100 (PLC Register)
Graph	<p style="text-align: center;">State0</p>  <p>Using vector graphics ,</p>

Number display element _2

PLC Number*	1
Read Address	D 100 (PLC Register)
Graph	<p style="text-align: center;">State0</p>  <p>Using vector graphics ,</p>

Bit State Lamp

PLC Number *	2
Read Address	CIO _bit 100.00 (PLC Register)
Graph	<p style="text-align: center;">State0 State1</p>  <p>Using vector graphics ,</p>

※A multi-machine HMI by changing the components Attribute required of the [PLC number] to distinguish PLC control object.

After setting, save the project, compile and download.

③ Use the appropriate communication cable are connected HMI and PLC 0, PLC 1, PLC 2, after the success of communication is established on the HMI monitor VW 100, D100 data as well as the state of Q 0.0

- Single HMI with multiple PLC / controller (the same communication protocol) communication

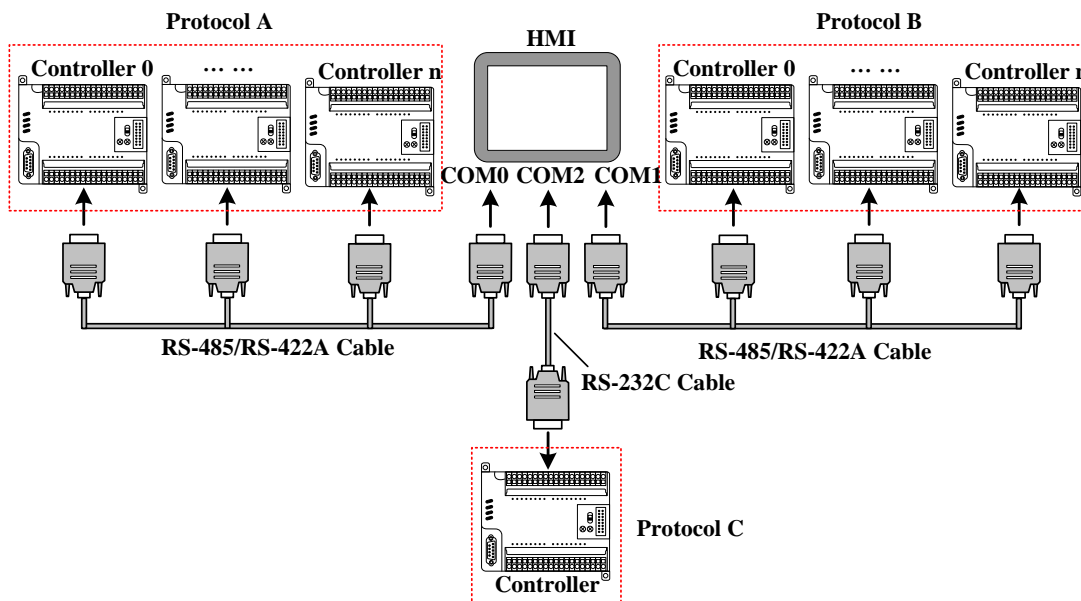

[Example] Below a MT5320T with three MODBUS device (hereinafter referred to as PLC 0, PLC 1, PLC 2), a MITSUBISHI FX2N (hereinafter referred to as PLC 3), a OMRON CP1H (hereinafter referred to as PLC 4) communication is cases, Requirements were monitored on the HMI PLC 0, PLC 1, PLC 2 of 4X 100, PLC 3 of D100 data and PLC 4 of Q 0.0 outputs.

(This example uses the HMI COM0 port to connect PLC 0, PLC 1, PLC 2, COM1 connected PLC 3, COM2 communication connection PLC 4)

- 1 Configure the device in the topology window and set the communication parameters

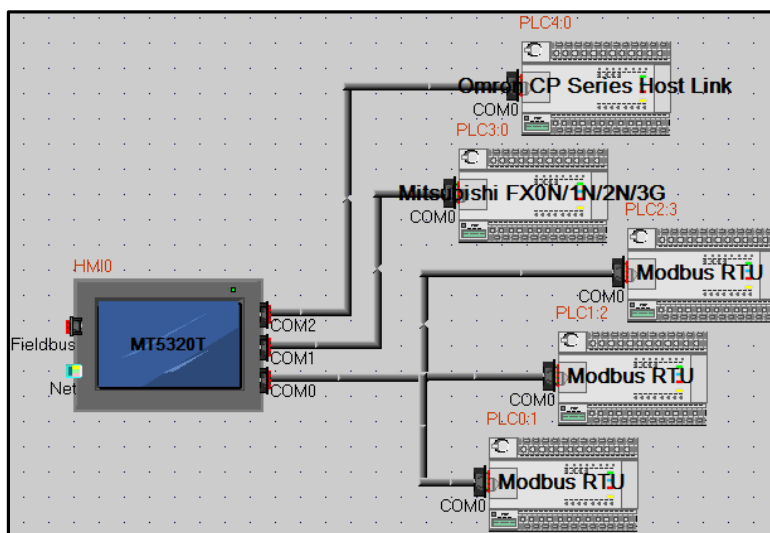

In the [HMI Attribute] - [Serial 0/1/2 setup] According to the serial communications port of the connected PLC actual parameters were set to HMI serial communication parameters, the parameters are set as follows :

HMI Serial ports	Serial communication parameters
COM0	RS485-2, 9600, 8, Even parity, 1
COM1	RS485-4, 9600, 7, Even parity, 1

COM2	RS232, 9600, 7, Even parity, 2
------	--------------------------------

In the PLC 0, PLC 1, PLC 2 [PLC Attribute] , in accordance with the actual [PLC station number] to each station number setting :

PLC Number	Station number
PLC 0	1
PLC 1	2
PLC 2	3
PLC 3	0
PLC 4	0



Connected to a serial port on the HMI with PLC / controller must be set to a different station number and station number set to be connected with the actual PLC / controller station number consistent

2 Edit the configuration screen

Double-click the HMI in the topology window icon to open the Configuration Editor window, respectively, from the [Graph Element window] - [PLC Parts] selected four "Number Display" and a "bit status indicator" component added to the Configuration Editor window, element attributes are set as follows:

Number display element _1/2/3

PLC Number*	0	1	2
Read Address	4X 100 (PLC Register)		
Graph	State0 Using vector graphics, 		

Number display element _4

PLC Number*	4
Read Address	D 100 (PLC Register)
Graph	State0 Using vector graphics, 

Bit Lamp

PLC Number*	5
Read Address	CIO_bit 100.00 (PLC Register)
Graph	State0 State1 Using vector graphics, 

※A multi-machine screen by changing the components required Attribute of the [number] to distinguish PLC control object.

After setting, save the project, compile and download.

③ Use the appropriate communication cable are connected HMI and PLC 0, PLC 1, PLC 2, PLC 3, PLC 4, after the success of communication is established on the HMI monitor VW 100, D100 data and Q 0.0 state.

14.1.3 Serial Communication Related Settings

(1) Kinco HMIware allowed through "Exchange serial 0 and serial 1 " option will COM0 and COM1 serial port communication parameters and settings in these two serial ports to connect devices on the exchange.

 [For details about serial to exchange, refer to \[Advanced Part 2.9 Exchange Serial\]](#)

(2) Users in making redundant communication, it can provide a system through Kinco HMIware special register to mask the corresponding fault site communications.

 [For details about the Station No. Shield, refer to \[Advanced Part 15 Register\]](#)

(3) When the HMI and PLC / controller serial communication failure occurs, the system will automatically prompt the corresponding fault error message. Fault error message contains information about the PLC station number in hexadecimal data display.

Meanwhile, the user can customize the system to provide fault error message content or special registers through the system to mask the corresponding fault error message.

 [For details about the System Information screen, refer to \[Advanced Part 15 Register\]](#)

 [For details about the system customization, refer to \[Advanced Part 6.1.4 HMI System Information Text\]](#)

14.2 Network Port Communication

Ethernet has a high transmission speed, low power, easy to install and good compatibility and other advantages, it is widely used in industrial automation control system.

HMI via Ethernet communication mainly in the following two ways:

One is through the ends of the Straight through Cable RJ45 connector or Crossover Cable, via a hub or switch communications;

Another is through the RJ45 connectors at both ends of the Crossover Cable, not through a hub or switch communications, this approach only applies to one pair of a communication.

14.2.1 HMI and PC Network Port Communication

HMI via RJ45 connectors at both ends of the Crossover Cable and PC-side network interface connector for user projects, recipes and other data upload / download and HMI firmware update.

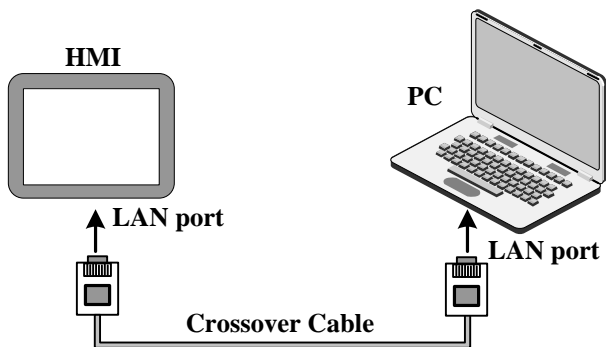

[For more details about HMI via Ethernet port on uploading and downloading, refer to \[Advanced part 7 Compile / Simulate / Download / Upload\]](#)

14.2.2 HMI and HMI Port Communication Network

HMI and HMI port communication network are the following two ways:

- Single HMI and single HMI communication

Single HMI and single HMI via a network port communication, through both ends of the cross UTP RJ45 connector is connected directly communicate.

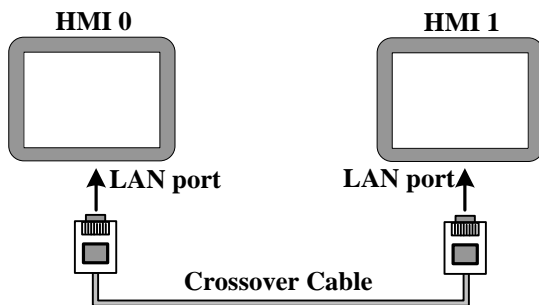

- Multiple (two or more) HMI group network communication

Multiple HMI via the network port communication, need to communicate through the Hub or Switch connection.

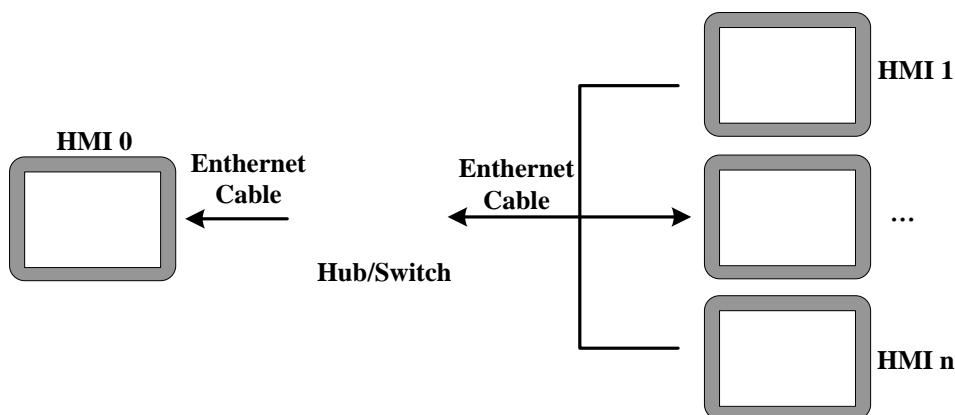

[Example] Below two MT5320T communication, for example, requires HMI0 screen control HMI1 of LB100 status output to ON.

- 1 Configure the device in the topology window and set the communication parameters

In the [HMI Attribute] - [HMI] - [Network Configuration Settings], click [Add] Configuring the HMI network port

communication parameters :

HMI Number	Communication protocol	IP Address
HMI0	Kinco	192.168.100.240
HMI1	Kinco	192.168.100.241

Once configured, the topology diagram and bus configurations are listed below :

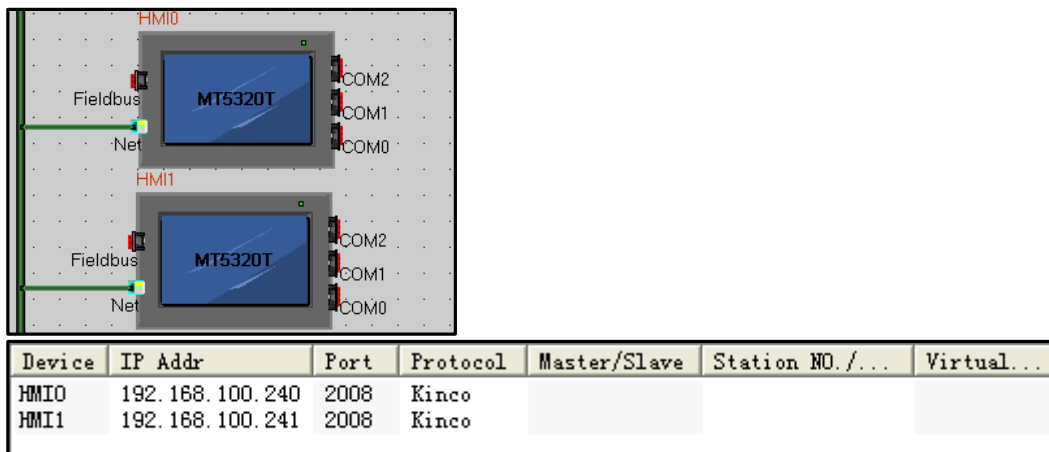

② Edit the configuration screen

In the topology window, double HMI0 icon to open HMI0 Configuration Editor window, from the [Graph Element window]

- [PLC Parts], select “ Bit State Setting” added to the Configuration Editor window, the component property is set to :

HMI*	1
Write Address	LB 100 (HMI Local register)
Switch Type	toggle
Graphics	<div style="display: flex; justify-content: space-around; align-items: center;"> State0 State1 </div> <div style="display: flex; justify-content: space-around; align-items: center;"> <input type="checkbox"/> <input type="checkbox"/> </div> <p>Using vector graphics,</p>

※In Multi-screen network, elements required by changing the properties of the [number] to distinguish between the touch screen control object.

After setting, save the project, compile and download

③ Use a crossover cable to connect HMI0 and HMI1, after the communication is established successfully, you can touch on the HMI0 Bit State Setting Part, Can be HMI1 LB100 state turns ON.

14.2.3 HMI and PLC/Controller Network Port Communication

HMI and PLC communications network ports are the following ways :

- Single HMI and single PLC communication network port

Single HMI and single PLC communication via Ethernet port, through the ends of the cross UTP RJ45 connector is connected directly communicate.

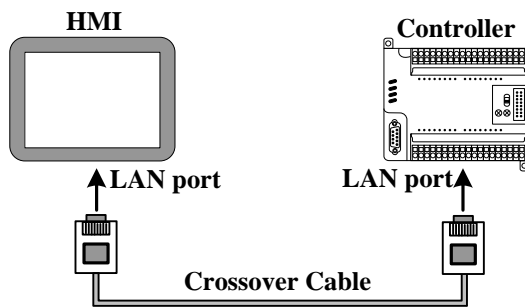

- Single HMI and multiple PLC network port communication

Single HMI and multiple PLC communication via Ethernet port, need to communicate through the Hub or Switch connection.

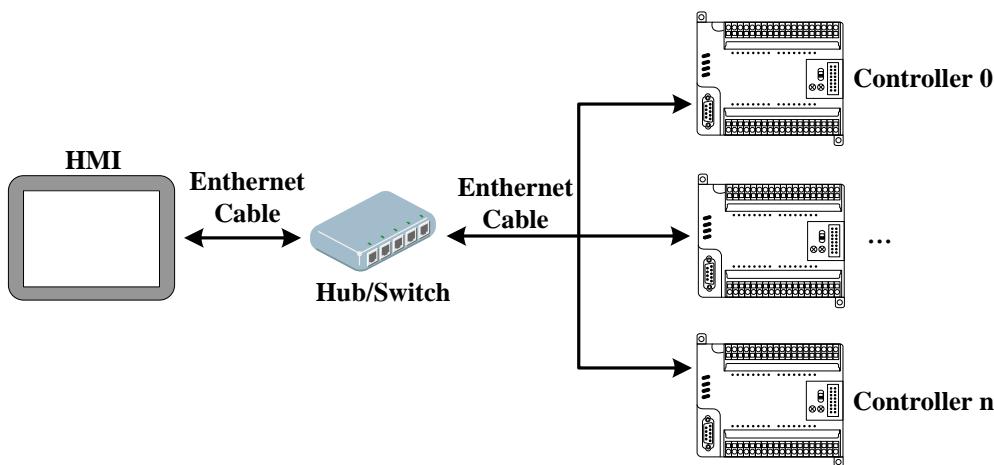

- Multiple HMI and multiple PLC communication network port
- Multiple HMI and multiple PLC communication via Ethernet port need to communicate through the Hub or Switch connection.

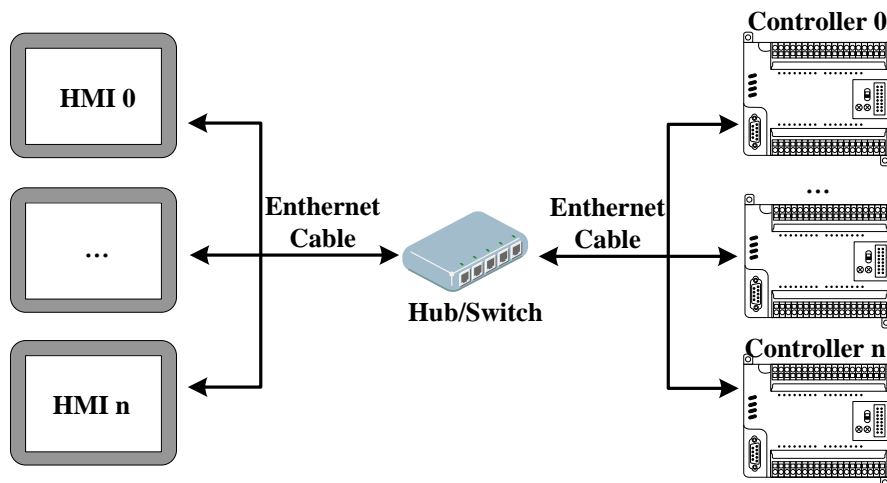

[Examples] Below two MT5320T (hereinafter referred HMI0 and HMI1) and one MODBUS TCP device (hereinafter referred to PLC0), and one OMRON CJ series PLC (hereinafter referred to PLC1) communications as an example. Require to monitor the data of PLC0 4x100 in the HMI0, and to monitor the data of PLC1 D100 in HMI1.

- 1 Configure the device in the topology window and set the communication parameters

In **[HMI Attribute]** — **[HMI]** — **[Network Device Settings]**, Click **[Add]** configuring the HMI network port communication parameters.

Setting HMI:

HMI NO.	IP Address	Communication protocol
HMI0	192.168.100.240	Kinco
		Modbus TCP
		Omron CJ Series Ethernet(TCP)
HMI1	192.168.100.241	Kinco
		Modbus TCP
		Omron CJ Series Ethernet(TCP)

Setting PLC: The IP address set here with the actual IP address of the PLC consistent

PLC NO.	IP Address	Communication protocol
PLC0	192.168.100.2	Modbus TCP Slave
PLC1	192.168.100.201	Omron CJ Series Ethernet(TCP Slave)

After configuration, the topology diagram and field bus setting are listed below :

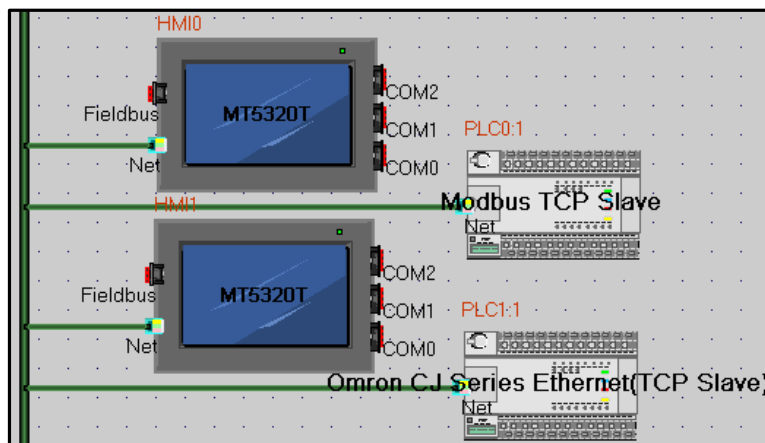

Device	IP Addr	Port	Protocol	Mast...	Stati.
HMI0	192.168.100.240	502	Modbus TCP	M	
HMI0	192.168.100.240	2008	Kinco		
HMI1	192.168.100.241	9600	Omron CJ Series Ethernet(TCP)	M	
HMI1	192.168.100.241	2008	Kinco		
PLC0	192.168.100.2	502	Modbus TCP Slave	S	1
PLC1	192.168.100.201	9600	Omron CJ Series Ethernet(TCP Slave)	S	1

② Edit the configuration screen

In the topology window, double HMI0 icon, opens HMI0 configuration Editor window, from **[Graph element window]** —

[PLC Parts] choose “Number Display” element add to Configuration Editor window, Element attribute is set to:

HMI*	1
Read Address	4x 100 (PLC Register)

Graphics	State0  Using vector graphics,
----------	---

Then opens the Configuration Editor window of HMI1, from **【Graph element window】** — **【PLC Parts】** choose “Number Display” element add to Configuration Editor window, Element attribute is set to:

HMI*	0
Read Address	D 100 (PLC Register)
Graphics	State0  Using vector graphics,

※Multi-screen network elements required by changing the properties of the [number] to distinguish between the touch screen control object.

After setting, save the project, compile and download.

③ Using crossover or straight-through cable through the Hub or Switch are connected HMI0, HMI1, PLC0, PLC1, after successful communication can be established to monitor the PLC0's 4x100 data in HMI0 and to monitor the PLC1 D100 data in HMI1

14.2.4 FTP Function

Kinco HMIware open the FTP functions, can transport files of external storage device to the PC via the LAN, or transport files of PC to external storage device.



FTP function is only available with USB HOST or SD card interface and an HMI with Ethernet port.

【Examples】 Through the LAN to access MT5320T U disk file, HMI's IP address is 192.168.100.241.

① In **【HMI Attributes】** — **【HMI】** open the property page FTP function.

Select **【open FTP】**, setting password: 123456.

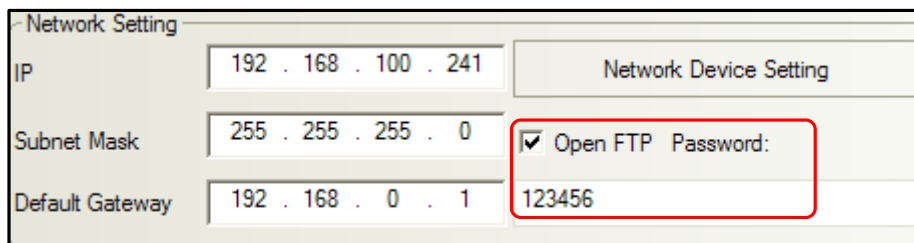

1. FTP default password is 888888.
2. FTP password are not supported characters, cannot be empty, only digits.

② In **【HMI Attributes】** — **【HMI】** configure the HMI network parameters. Set the IP address of the current HMI: 192.168.100.241,, Not to modify the subnet mask and default gateway.

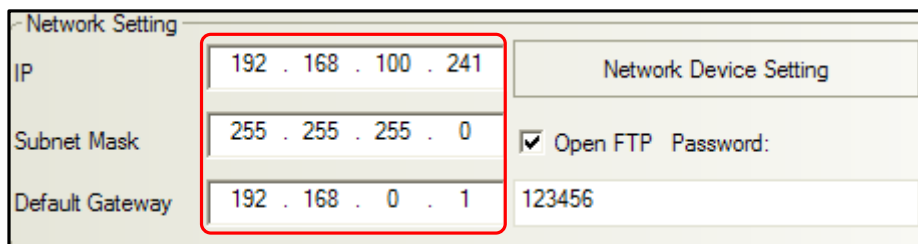

③ Save, compile, then downloading the project.

Use cross or straight-through cable via Hub or Switch to access the HMI LAN. Open the IE browser or Explorer, in the address bar, enter the IP address of the HMI: ftp://192.168.100.241, Enter the system will automatically pop-up dialog [Login identity], Enter the user name: root, Password: 123456, you can log into the FTP server.

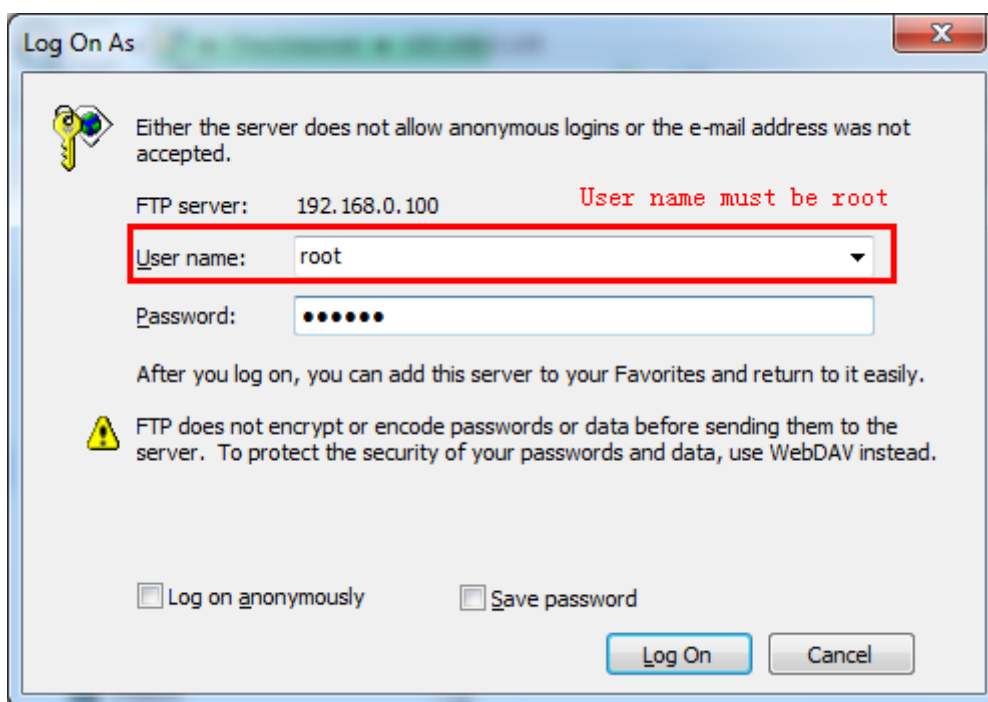

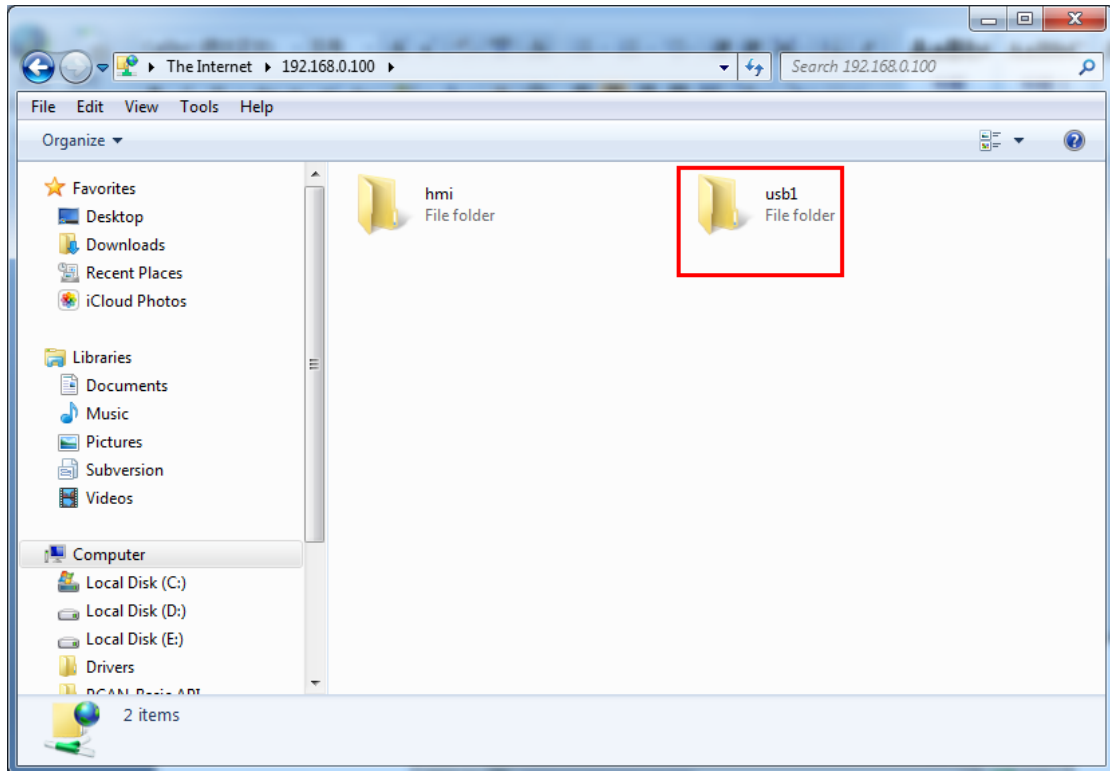

- 5 Open usb1 folder, internal documents can browse. But also can be copy their files to a PC or copy files from the PC to the U disk.

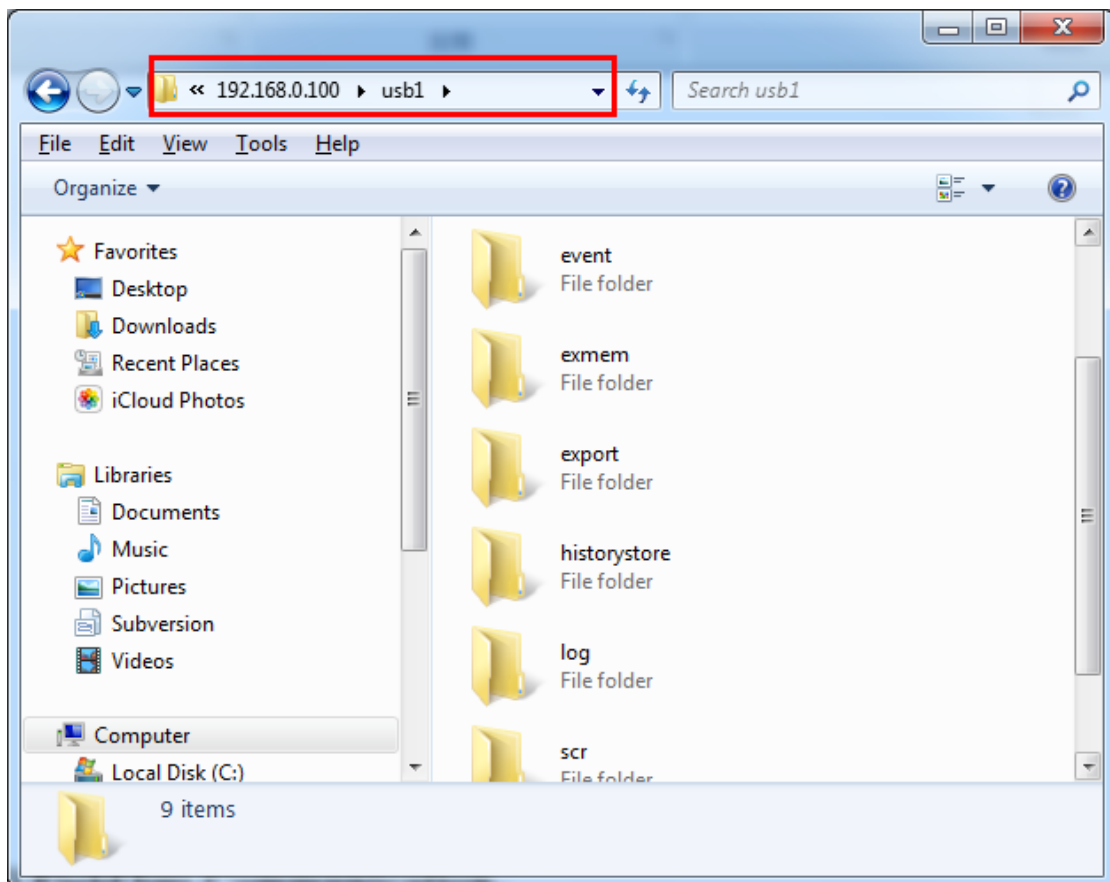

14.3 Field Bus Communication

Fieldbus is a kind used in the production site, between devices in the field, between field devices and control devices implement two-way, string-shaped, multi-node digital communication technology. Kinco HMIware Supports field bus communication with CAN and Profibus-DP.

14.3.1 CAN Communicate

Kinco HMIware provided CANOpen Node Slave HMI communication protocol can be realized as a slave device with CANOpen communication between the master devices.

[Examples] Take one MT5320T-CAN screen and one CAN communications equipment for example.

① In Kinco HMIware topology window to configure the device and set the communication parameters
 Double-click the HMI icon in the topology window, in **【HMI Attribute】** — **【HMI】** — **【Field bus setting】**, Click **【Add】** configuring the HMI communication parameters.

Setting **【Protocol】** for "CANOpen Node Slave"; The remaining parameter settings and the connected CAN device communication parameters are consistent.

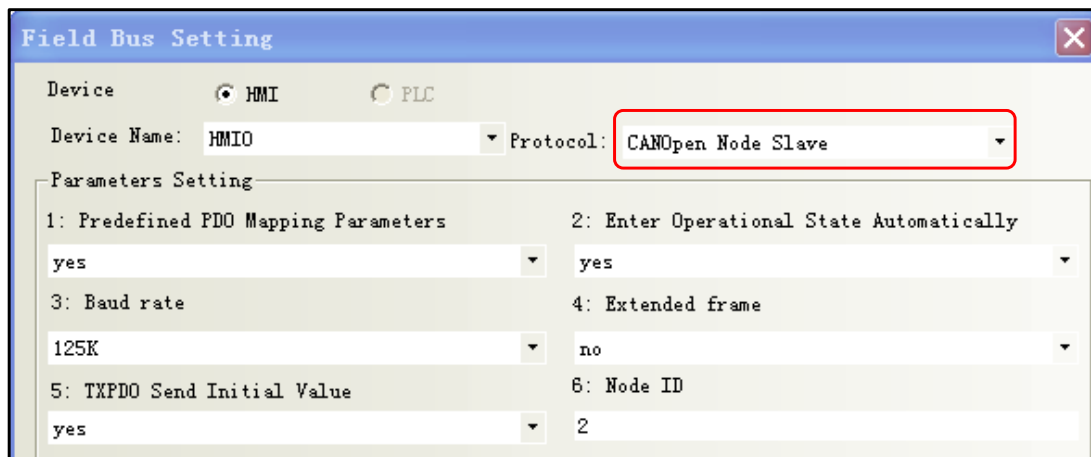

After configuration, the topology diagram and bus configurations are listed below:



Device	Protocol	Master/Slave	Station NO./Node ID	Virtual PLC No.
HMIO	CANOpen Node Slave	S	2	

② Edit the configuration screen

Place the “number input/display” in configuration screen, Address Range LW8000~8031. Save and compile and download the project.

③ Configuration of the CAN device



For more information on the CAN device configuration, see [Communication connection instructions]CanOpen Node Slave(CANOpenSlave protocol) related content

④ Communications configuration and communication cables are set up, after successfully established communication, HMI can read and write operations on the CAN devices.

14.3.2 DP Communicate

The DP of PROFIBUS-DP is Decentralized Periphery, is a field bus. It has the characteristics of high-speed low-cost, Used for device-level control systems and distributed I / O communications.

In Kinco HMIware , HMI software provided by the communication protocol Profibus Slave ,HMI as a slave device and supports Profibus-DP communication protocol PLC / controller communications.

HMI as a slave device, HMI local address LW is mapped to PIW(D)/PQW(D), Written to or read from the PLC.

The correspondence relation table of registers below:

PLC Register Address	Local address range corresponding HMI
PIW(D)	LW8500~8615
PQW(D)	LW8000~8115



With PLC / controller communication via Profibus DP HMI must be extended with Fieldbus interfaces and the DP model

[Examples] Below a MT5320T-DP and a SIEMENS S7-300 communication, for example, requires the HMI monitor PLC PQW256 data.

① Installing the GSD file by STEP7 software

Slave devices need to have a device description file, is used to describe the characteristics of DP the device, This file is called GSD file, This file usually contains device-specific parameters: Such as baud rate, the input / output data length, IO data definition. It is an ASCII text file format, Usually provided by the device manufacturer.



Kinco provided "kinco.gsd" File can find In Kinco HMIware installation directory fieldbus folder or

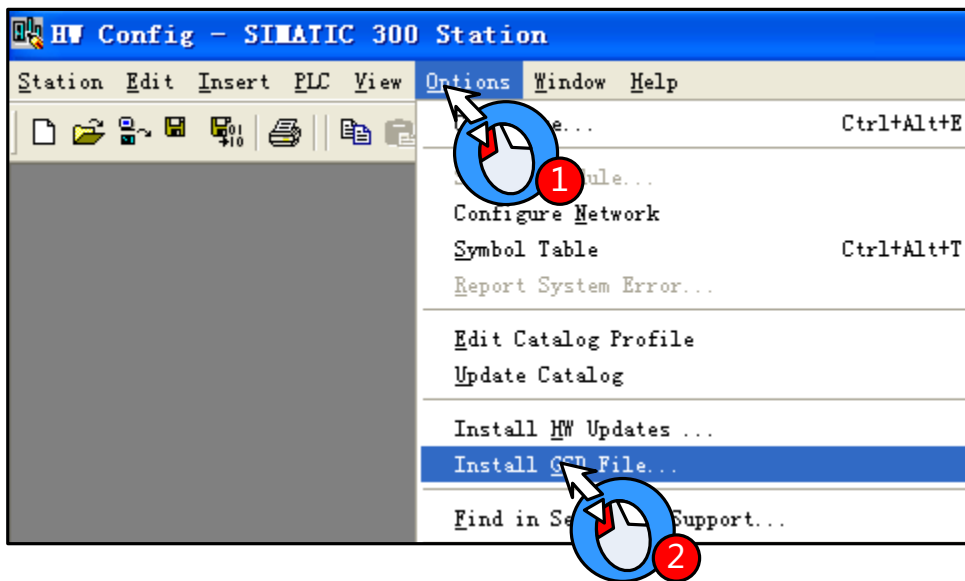

GSD file installed, Right in the HW Config directory PROFIBUS DP / Additional Field Devices / MMI find the appropriate configuration file:

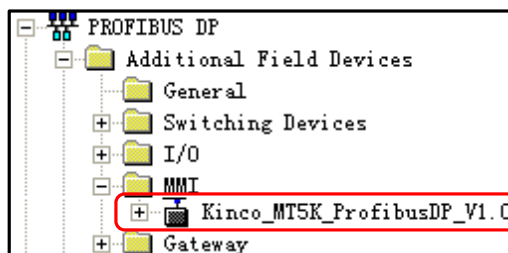

2 PLC hardware configuration

Open SIMATIC Manager, in the block configuration Insert included OB1、OB82、OB86、OB100、OB121、OB122 tissue blocks:

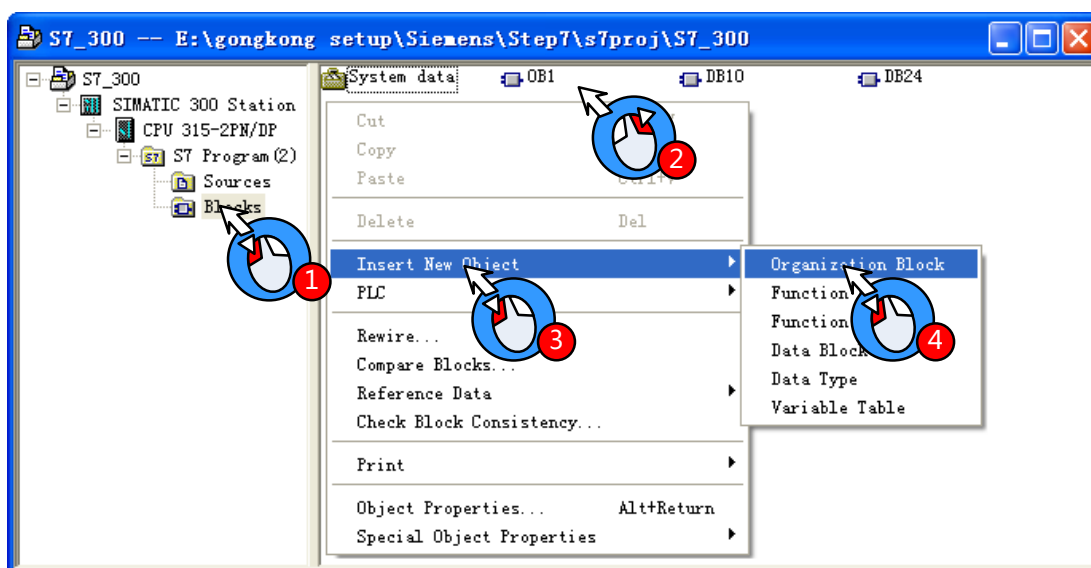

Open HW Config, add Master System:

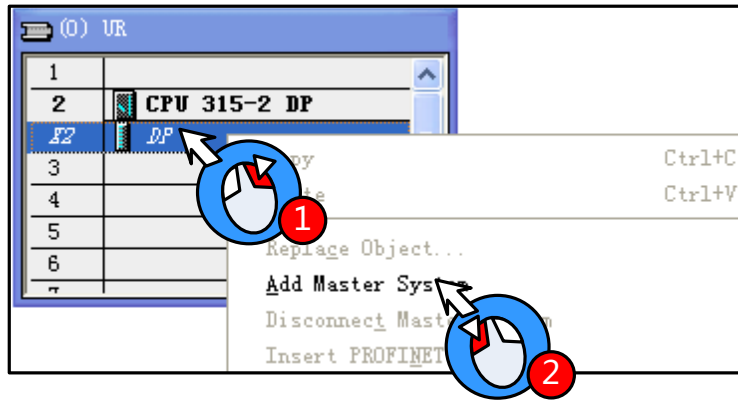

After appears the main rail station system, Configure the master system

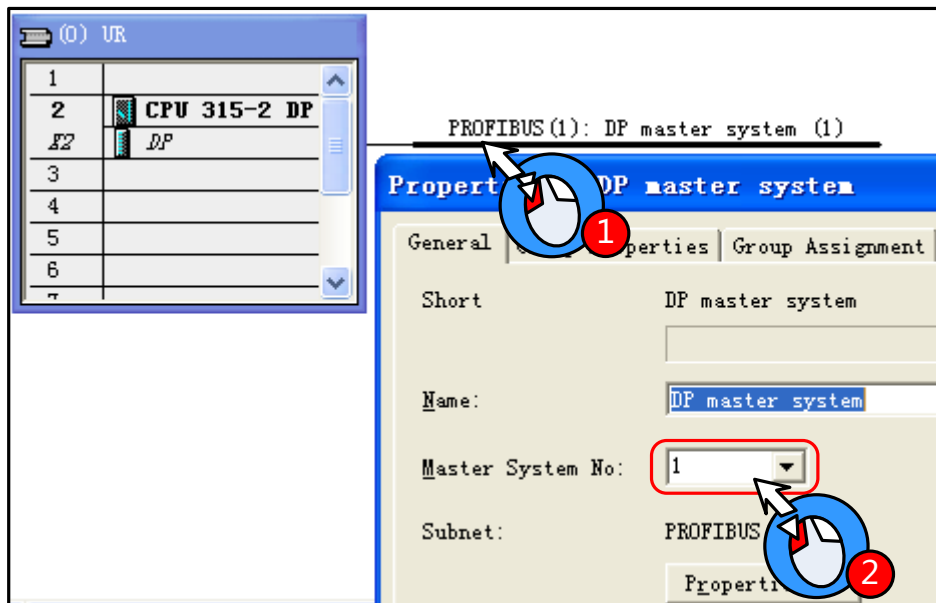

Add a slave:

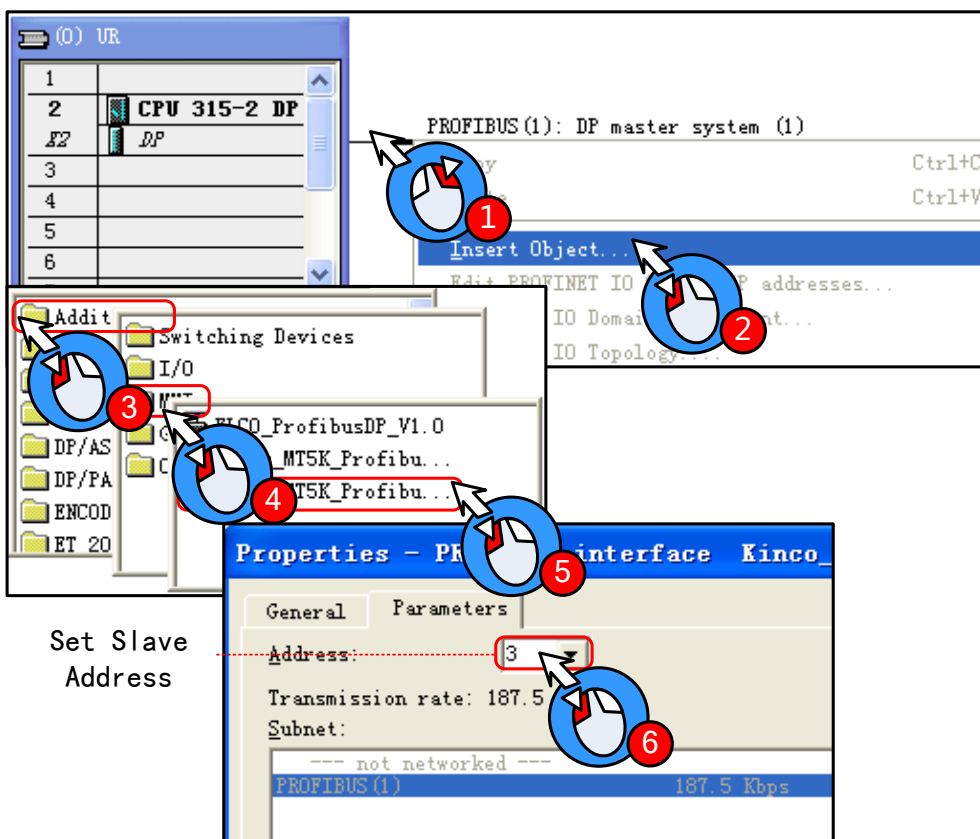

Set Slave Address



DP master system and the slave device address number cannot be the same; In addition slave device transfer rate adaptation, without setting

Configuring the slave input and output resources: This example configure 16 Words Input , 16 Words Output , PIW address from 256~287 , PQW address from 256~287

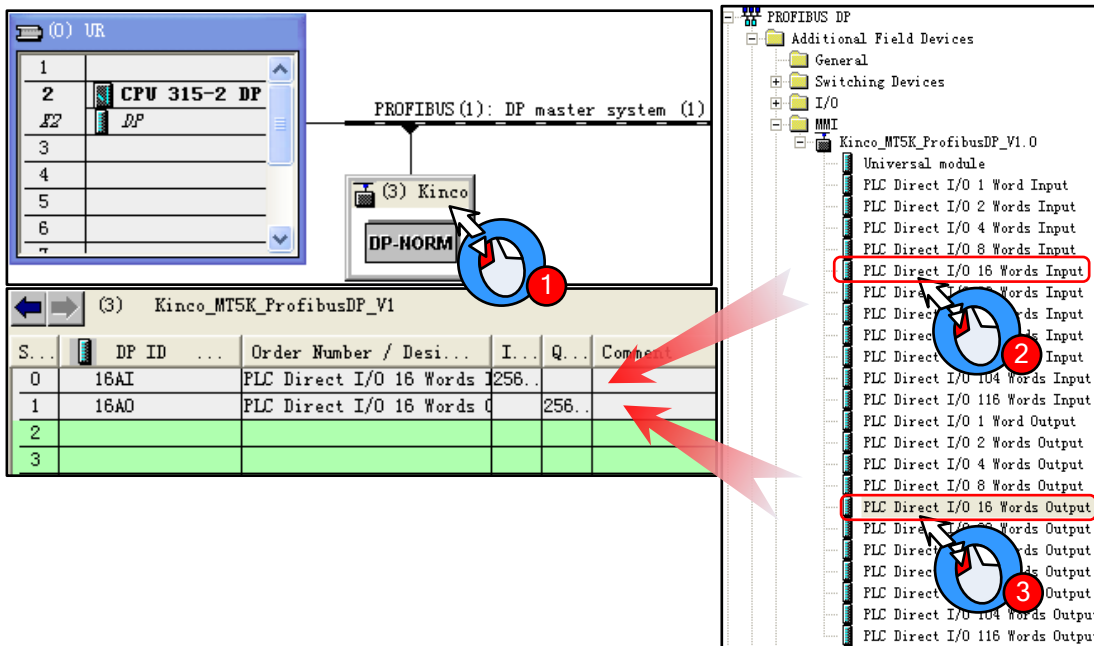

Setting User_Prm_Data(0): Double-click the slave station device icon, in **DP slave** — **Parameter assignment** set User_Prm_Data(0)为 1

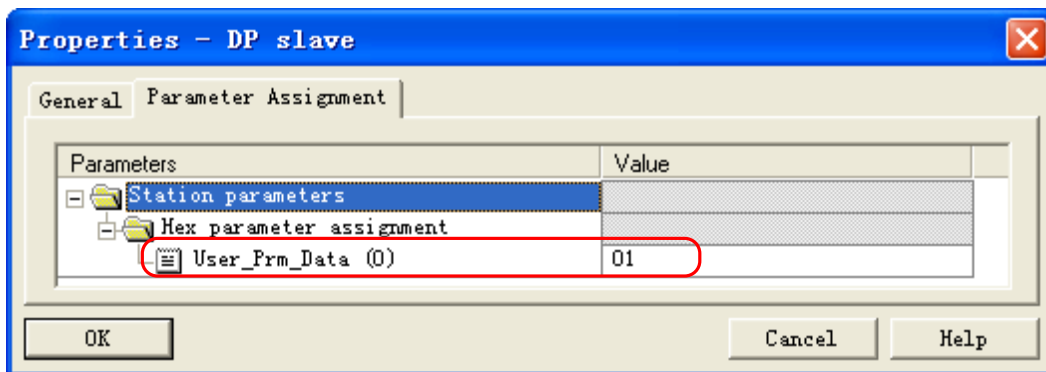

When LW using double word, only with SIEMENS products through DP communication, only need to User_Prm_Data (0) is set to 1; If communicate with a master device support other DP protocol, User_Prm_Data (0) defaults to 0.

- ③ In Kinco HMIware topology window to configure the device and set the communication parameters
 Double-click the HMI icon in the topology window, in **HMI Attribute** — **HMI** — **Field bus setting**, Click **Add** configuring the HMI communication parameters.
 Setting **Protocol** for “Profibus Slave”; **Input/output Modules** Are set to 16 Words, should match with HW Config Slave device input and output resources; Slave address should match with HW Config.

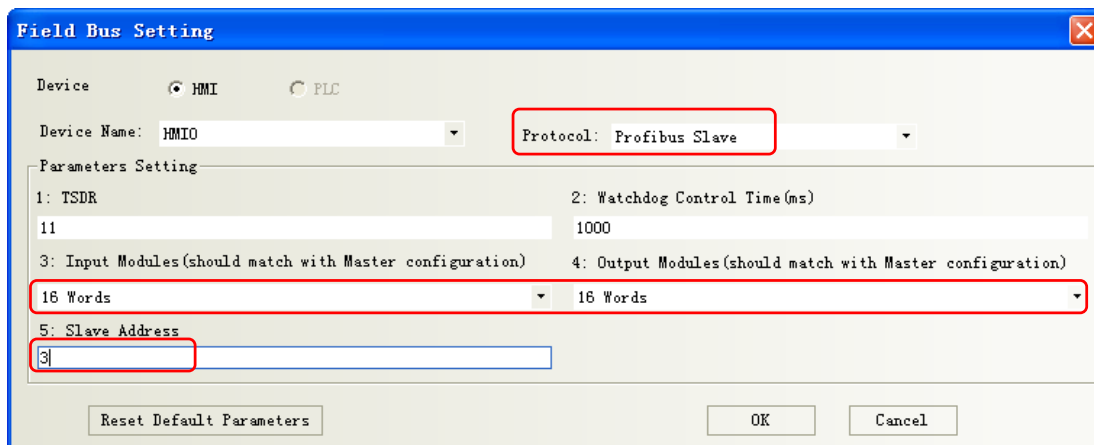

Input/ Output Modules should match with Master configuration, The max length are 116 words.

After configuration, the topology diagram and bus configurations are listed below:

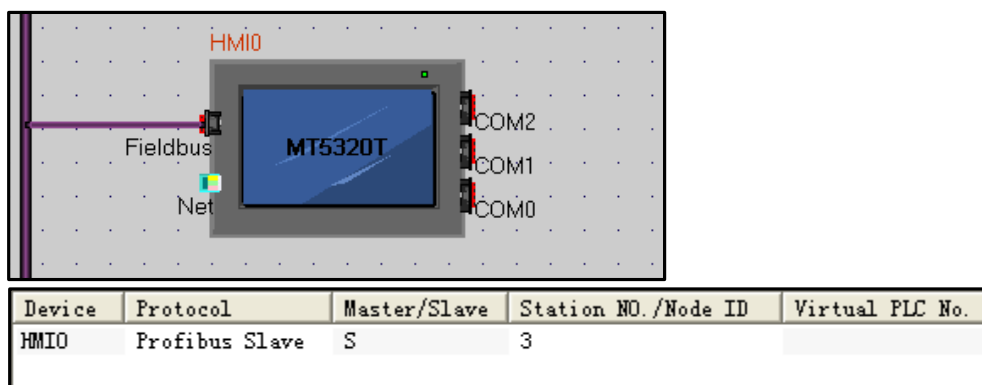

4 Edit the configuration screen

Double-click the HMI icon in the topology window, and open the Configuration Editor window, in【Graph element window】— 【PLC Parts】 Select "Number Display" component added to the Configuration Editor window, Element attribute is set to:

Read Address	LW 8000(HMI Local address)
Graphics	<p>State0</p> <p>Using vector graphics,,</p>

After setting, save the project, compile and download.

Using DP communication cables are connected the HMI and PLC, After successful communication established, can monitor PQW256 data on the HM.

14.4 MPI Communicate

MPI is the multi-point interface (Multi Point Interface) for short, is developed for PLC communication by Siemens. MPI communication when the communication rate is less demanding, communication data is not used when a cheap and easy means of communication. The main advantage of MPI communication CPU can establish communications with multiple

devices, Such as PG / PC programming, HMI device (PC) and the other PLC can be connected together to run simultaneously. MPI interface using RS-485 physical interface mode, the transmission rate can be 19.2kbit / s or 187.5kbit / s.

In Kinco HMI ware in, HMI software provided by SIEMENS S7-300/400 (MPI Direct) communications protocol, as the master station and HMI MPI communication protocol support PLC / controller communications.



With PLC / HMI controller via MPI communication must be extended with Fieldbus Interface and is-MPI model.

[Examples] Below two MT5320T-MPI (hereinafter referred HMI0 and HMI1) and two SIEMENS S7-300 (hereinafter referred to PLC0 and PLC1) communications, for example, requires HMI0 monitoring PLC0 data on data block variables DB10.DBW 10.

1 In STEP7 Software Configure PLC side communication parameters

Create a New Project , Under this project insert two PLC stations , are STATION1(CPU315-2DP) and STATION2(CPU315-2DP), Respectively, to complete the hardware configuration into the CPU , Establish MPI network and configure the MPI station address and baud rate , In this example, the MPI station addresses are set to No. 2 and No. 3, and communication rate 187.5kbit / s.



1. Throughout the MPI network communication rate must be consistent and MPI station addresses cannot conflict.

2. When the PLC with 4 or 4 above HMI communication, Need to set the [attributes] - [Communications] to change the parameters of PG communication.

For example , CPU 315-2DP , CPU default PG communication number is 1 , OP communication for the 1, S7 standard communication is 12, while the maximum number of connection resources 16; The number of the previous three together is always more than the maximum number of connection resources 16 less two, that means there are two shared an office for the first three, So S7 300 CPU is always maximum and three HMI communication, cannot be even the first four, If you need to increase the number of connecting HMI, just to reduce the number of S7 standard communication to further increase the number of PG communication and keep three of the total does not exceed the maximum number of 16 connection resources can be. To increase communication between the PLC, will have to increase the number of OP communication.

2 Configure DB data block

In the SIMATIC Manager to add the data block DB10, in this case the data required to monitor DB10.DBW 10, the definition of a variable data block DB10, the need to define DB10.DBW 0 ~ DB10.DBW 14 or more variables.



1. Define data block variables, note: the variable data type to be set in the HMI data type. Such as data type REAL, then the values in the HMI device data types required to single-precision floating-point
 2. Ensure that the data defined in the PLC HMI block variable than the actual use of the data block variables and more.
- For example, used in the HMI DB5.DBW32, the PLC cannot be defined only to DB5.DBW32, but defined to DB5.DBW34 or DB5.DBW36 or more

3 In Kinco HMIware topology window to configure the device and set the communication parameters. Double-click the HMI icon in the topology window, in **【HMI Attribute】 — 【HMI】 — 【Field bus setting】**, Click **【Add】** configuring the HMI communication parameters. Setting HMI: in **【Device Name】**select the appropriate configuration object, and set **【protocol】** “MPI”, **【Baud Rate】** should be match with the actual PLC communication port consistent.

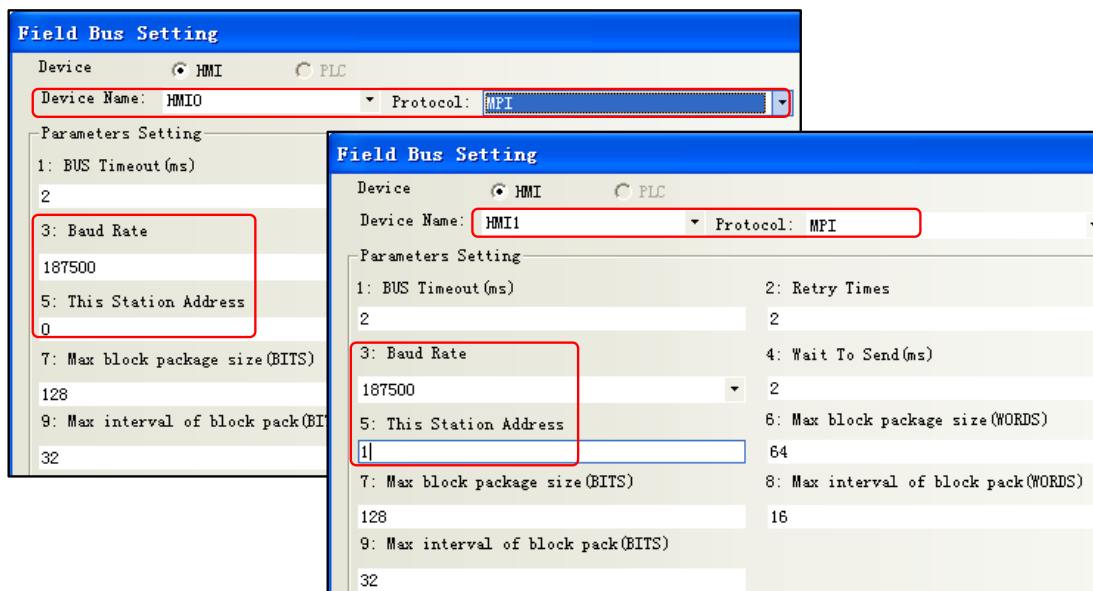

MPI network connecting multiple master devices, pay attention to the **【master station number】** setting and cannot be the same.

Setting PLC: in **【Device Name】**select the appropriate configuration object, **【Target Address】** should be match with the actual PLC station number consistent.

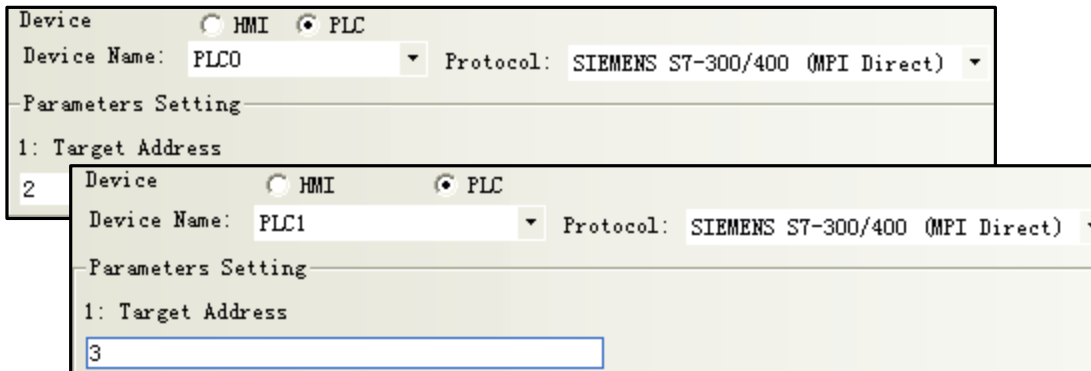

After configuration, the topology diagram and bus configurations are listed below:

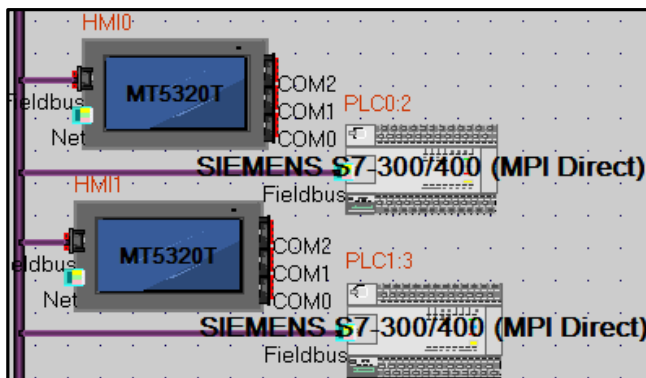

Device	Protocol	Master/Slave	Station NO./...	Virtual PLC
HMI0	MPI	M		
HMI1	MPI	M		
PLC0	SIEMENS S7-300/400 (MPI Direct)	S	2	
PLC1	SIEMENS S7-300/400 (MPI Direct)	S	3	

④ Edit the configuration screen

Double-click the HMI icon in the topology window, and open the Configuration Editor window, in【Graph element window】

— 【PLC Parts】 Select "Number Display" component added to the Configuration Editor window, Element attribute is set to:

PLC No.*1	0
Read Address	DBn_DBW 1000010 (PLC Register) *2
Graphics	<p style="text-align: center;">State0</p>  <p>Using vector graphics,</p>

※1. A multi-screen or multi-screen multi-machine, Need to change element attributes 【PLC No.】 to distinguish control object.

2. In the HMI, the address type DBn_ DBX, DBn_DBW, DBn_DBD as custom data block address. The first three data formats for the data block number, later five for the address, address less than five to the previous zero padding.

After setting, save the project, compile and download.

Using MPI communication cables are connected HMI0, HMI1, PLC 0, PLC 1, after the success of communication is established to monitor DB10.DBW10 in HMI0.

14.5 MODBUS Protocol Applications (Master-slave mode)

MODBUS protocol is a common language applied on the electronic controller. Over this protocol, between the controller, the controller through the network (such as Ethernet), and other devices can communicate. Today, MODBUS protocol has become a common industry standard by which different manufacturers of industrial control equipment can be connected into the network, thereby performing centralized monitoring.

14.5.1 MODBUS Protocol Overview

Modbus is a request / response protocol, and provide services required by the function code.

Modbus protocol including ASCII, RTU, TCP, etc., does not require the physical layer. Protocol defines the controller can recognize and use the message structure, regardless of what network they are communicating. The Modbus ASCII, RTU protocol provides news, data structures, commands, and fluent manner , Data communication using Maser / Slave mode , Master station data request message, the slave receives the correct data can be sent after a message to the master station in response to the request ; master can also be directly send message modify the data from a slave, two-way read and write.

MODBUS stipulates that only master station has the initiative, only a passive response from the slave, including answering error message.

MT Series HMI Modbus protocol communications to achieve, follow the standard Modbus communication process:

Common data frame format is as follows :

Address Code	Function Code	Data Area	Error Correction Code
8Bits	8Bits	N×8Bits	16Bits

- Address code

Address field of a message frame contains two characters (ASCII) or 8Bit (RTU). Possible from the device address is 0 ... 247 (decimal). Single device address range is 1 ... 247. To contact master device through the slave device address into the address field of the message to select from the device. When a message is sent from the device to respond, he put his address in response to the address field in order to know which device is the master device to respond. Address 0 is used as the broadcast address and all slave devices will recognize.

- Function code

In the HMI system, commonly used function codes are as follows :

Modbus Function code	Name	Function	Corresponding address type
01	Read Coil Status	Read bit (Read N Bits)	0x
02	Read input discrete	Read bit	1x
03	Read multiple registers	Reading integer, character, status word, float (Read N Words)	4x
04	Read Input Registers	Reading integer, status word, float	3x
05	Write Single Coil	Write bit (Write a Bit)	0x
06	Write Single Register	Write integer, character, status word, float (Write a Word)	4x

15	Write multiple coils	Write bit (Write N Bits)	0x
16	Write Multiple Registers	Write integer, character, status word, float (Write N Words)	4x

- Data Area

Data area contains the specific function of the terminal data needed to respond to queries or the terminal to collect data. These data may be numeric, reference address or set values. For example: Function code tells terminal reads a register the data area from which you need to specify the beginning and read the number of register data, the embedded addresses and data types according to the contents of the slave varies.

- Error correction code

Modbus protocol data needs to checksum, in addition to the serial protocol parity outside, ASCII mode uses the LRC parity, RTU mode uses a 16-bit CRC checksum, TCP checksum mode without additional requirements.

- Parity

Users can configure the controller is an odd or even parity, or no parity. This will determine the character of each parity bit is how to set up.

If you specify an odd or even parity, "1" digit will count to the number of bits in each character (ASCII Mode 7 data bits, RTU, 8 data bits). For example RTU character frame contains the following eight data bits: 1 1 0 0 0 1 0 1; The whole "1", the number is four. Such as the use even parity, the parity frame bit will be 0, so that the entire "1" bits remain is four. If the odd parity, the parity frame bit will be 1, so that the entire "1" bits is 5. If no parity bit, no parity bit is transmitted, nor checksum testing. Additional padding instead of stop bits to be transmitted character frame.

- LRC Detect

Using ASCII mode, messages include methods based LRC error detection domains. LRC field testing except the beginning of the message field colon and end carriage return line numbers outside content.

LRC field is a binary value that contains an 8-bit byte. LRC value calculated by the transmission device and into the message frame, the receiving device receiving the message in the process of calculating LRC, and place it in the message received LRC field value, and if the two values are unequal, there is an error.

LRC is the message of the continuous accumulation of bytes 8Bit, discarding the carry bit.

LRC Simple function as follows:

```
static unsigned char LRC(auchMsg,usDataLen)
unsigned char *auchMsg ; /* Message to be calculated */
unsigned short usDataLen ; /* LRC number of bytes to be processed */
{
    unsigned char uchLRC = 0 ; /* LRC Byte Initialization */
    while (usDataLen--) /* Send Message */
        uchLRC += *auchMsg++ ; /* Cumulative */
    return ((unsigned char)(~((char_uchLRC))) ;
```

}

➤ CRC Detect

Use RTU mode, the message including the method based on the CRC error detection fields. CRC field test the entire contents of the message.

The CRC field is two bytes that contains a 16 bit binary value. Calculated by the transmission equipment was added to the message. Receives the message receiving device recalculates the CRC, and with the received CRC value in the field, and if the two values are different, then an error.

CRC added to messages, the low byte of the first to join, and then the high byte. CRC simple function as follows:

```

unsigned short CRC16(puchMsg, usDataLen)
unsigned char *puchMsg ; /* the message to be CRC checksum */
unsigned short usDataLen ; /* The number of bytes in the message */
{
    unsigned char uchCRCHi = 0xFF ; /* High CRC byte initialization */
    unsigned char uchCRCLo = 0xFF ; /* Low CRC byte initialization */
    unsigned uIndex ; /* CRC cycle index */
    while (usDataLen-- /* Transmitted message buffer */
    {
        uIndex = uchCRCHi ^ *puchMsg++ ; /* Calculate the CRC */
        uchCRCHi = uchCRCLo ^ uchCRCHi[uIndex] ;
        uchCRCLo = uchCRCLo[uIndex] ;
    }
    return (uchCRCHi << 8 | uchCRCLo) ;
}

```

14.5.2 MODBUS Protocol Communication Format

Following through several examples, and use the serial debugging tools to send and receive data frames HMI listen to learn more about the Modbus protocol communication format.

The following examples are primary device HMI, PLC done from the device, and use the RTU transmission mode is described:

Topology diagram is shown below:

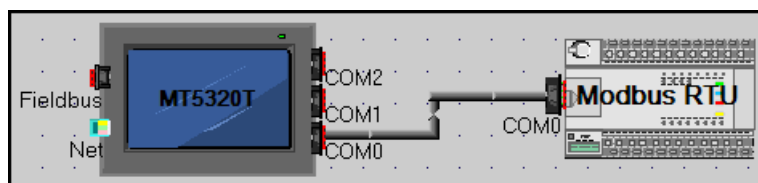

(1) 01 Function Code Application

Function Code 01 reads 0x10, 0x11, 0x12, 0x13, 0x14, 0x15 Bit of these six states.

Placed six "bit state lamp" parts in the HMI configuration, the read address are set to 0x10 ~ 0x15.

Running, the host (HMI) Request

Station no.	Function code	First address (High byte)	First address (Low byte)	Read Bit Number (high byte)	Read Bit Number (low byte)	CRC High byte	CRC low byte
01	01	00	09	00	06	6C	0A

Slave (PLC) response

Station no.	Function code	Byte count	Single byte of data	CRC High byte	CRC low byte
01	01	01	3A	D1	9B

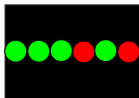
HMI debugging tools from the serial port to send data packets	HMI display
01H 01H 01H 3AH D1H 9BH	

0x15 HMI reads as ON, 0x14 is ON, 0x13 is ON, 0x12 is OFF, 0x11 is ON, 0x10 is OFF. 3A hexadecimal number is converted into binary to 111,010, corresponding exactly.

(2) 02 Function Code Application

Function Code 02 reads 1x999 this Bit state.

In the HMI configuration to place a "bit state lamp" part, the read address is set to 1x999.

Running, the host (HMI) Request

Station no.	Function code	First address (High byte)	First address (Low byte)	Read Bit Number (high byte)	Read Bit Number (low byte)	CRC high byte	CRC low byte
01	02	03	E6	00	01	58	79

Slave (PLC) response

Station no.	Function code	Byte count	Data (single-byte)	CRC high byte	CRC low byte
01	02	01	00	A1	88
01	02	01	01	60	48

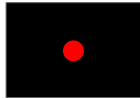
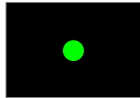
HMI debugging tools from the serial port to send data packets	HMI display
01H 02H 01H 00H A1H 88H	
01H 02H 01H 01H 60H 48H	

(3) 03 Function Code Application

Function Code 03 reads 4x 208 ~ 215 this 8 Words value.

Placed on the HMI configuration 8 "Number Display" component, the read address are set to 4x 208 ~ 215.

Running, the host (HMI) Request

Station no.	Function code	First address (High byte)	First address (Low byte)	Read Word Number (high byte)	Read Word Number (low byte)	CRC high byte	CRC low byte
01	03	00	CF	00	08	74	33

Slave (PLC) response

Station no.	Function code	Byte count	Data(1) High Byte	Data(1) low Byte	Data(2) High Byte	Data(2) low Byte	Data(3) High Byte	Data(3) low Byte	Data(4) High Byte	Data(4) low Byte
01	03	10	00	01	00	02	00	03	00	04

Data(5) High Byte	Data(5) low Byte	Data(6) High Byte	Data(6) low Byte	Data(7) High Byte	Data(7) low Byte	Data(8) High Byte	Data(8) low Byte	CRC high byte	CRC low byte
00	05	00	06	00	07	00	08	72	98

HMI debugging tools from the serial port to send data packets	HMI display
01H 03H 10H 00H 01H 00H 02H 00H 03H 00H 04H 00H 05H 00H 06H 00H 07H 00H 08H 72H 98H	

(4) 04 Function Code Application

Function Code 04 reads 3x 1023 the value of the Word.

Placed on the HMI configuration 8 "Number Display" component, the read address are set to 3x 1023.

Running, the host (HMI) Request

Station no.	Function code	First address (High byte)	First address (Low byte)	Read Word Number (high byte)	Read Word Number (low byte)	CRC high byte	CRC low byte
01	04	03	FE	00	01	50	7E

Slave (PLC) response

Station no.	Function code	Byte count	Data High Byte	Data low Byte	CRC high byte	CRC low byte
01	04	02	04	D2	3B	AD

HMI debugging tools from the serial port to send data packets	HMI display
01H 04H 02H 04H D2H 3BH ADH	

(5) 05 Function Code Application

Use 05 Function code to modify 0x 1 Bit state.

Place a "Bit State Setting" component in HMI, the write address is set to 0x 1, switch type is set to "Toggle."



Runtime on the HMI click "Bit State Setting" component to switch to the ON state, the serial debugging tools for the data received 01 05 00 00 FF 00 8C 3A; Be switched to the OFF state, the serial debugging tools for the data received 01 05 00 00 00 00 CD CA; (Among them, the hexadecimal value 0XFF00 requests coil to ON. Hexadecimal value 0X0000 request coil is OFF) Meanwhile, the serial debugging tools to reply to the same data.

The host (HMI) Request

Station no.	Function code	First address (High byte)	First address (Low byte)	Write Bit Number (high byte)	Write Bit Number (low byte)	CRC high byte	CRC low byte
01	05	00	00	FF	00	8C	CA
01	05	00	00	00	00	CD	CA

Slave (PLC) response

Station no.	Function code	First address (High byte)	First address (Low byte)	Write Bit Number (high byte)	Write Bit Number (low byte)	CRC high byte	CRC low byte
01	05	00	00	FF	00	8C	CA
01	05	00	00	00	00	CD	CA

HMI debugging tools from the serial port to send data packets	HMI display
01H 05H 00H 00H FFH 00H 8CH 3AH	
01H 05H 00H 00H 00H 00H CDH CAH	

(6) 06 Function Code Application

Use 06 Function code writes 4x 1 this Word value.

In the HMI configuration to place a "multiple state setting" component, the write address is set to 4x 1, set the mode to "set constant", set the value to 88.

Runtime on the HMI click on the " multiple state setting " component, the serial debugging tools received data to 01 06 00 00 00 58 88 30; while serial debugging tools To reply to the same data.

the host (HMI) Request

Station no.	Function code	First address (High byte)	First address (Low byte)	Write Word Number (high byte)	Write Word Number (low byte)	CRC high byte	CRC low byte
01	06	00	00	00	58	88	30

Slave (PLC) response

Station no.	Function code	First address (High byte)	First address (Low byte)	Write Word Number (high byte)	Write Word Number (low byte)	CRC high byte	CRC low byte
01	06	00	00	00	58	88	30

HMI debugging tools from the serial port to send data packets	HMI display
01H 06H 00H 00H 00H 58H 88H 30H	

(7) 15 Function Code Application

Use 15 Function code modify the 0x 10 ~ 25 this 16 Bit state.

In the HMI configuration to create a macro code: 15 function code. C, variables are defined as follows:

Data Type	Param name	PLC No.	PLC Address type	Address	WordNum	OptMode	Array	Array Length
bit	data	0	0X	10	1	Write	Yes	16

Code is as follows:

```

24 int MacroEntry()
25 {
26     short i;
27     for(i=0;i<16;i++)
28         data[i]=1;
29     return 0;
30 }
31
    
```

And then placed on a configuration screen "function key" component, the function is set to "execute macro code: 15 function code. C".

Running, click on the function keys on the HMI, the serial data received on debugging tools for the 01H 0FH 00H 09H 00H 10H 02H FFH FFH E3H 09H, while serial debugging tools, the reply data 01H 0FH 00H 09H 00H 10H 84H 05H.

The host (HMI) Request

Station no.	Function code	First address (High byte)	First address (Low byte)	Write Bit Number (high byte)	Write Bit Number (low byte)	Write Bit Byte count	Bit Data High Byte	Bit Data low Byte	CRC High Byte	CRC low Byte
01	0F	00	09	00	10	02	FF	FF	E3	09

Slave (PLC) response

Station no.	Function code	First address (High byte)	First address (Low byte)	Write Bit Number (high byte)	Write Bit Number (low byte)	CRC High Byte	CRC low Byte
01	0F	00	09	00	10	84	05

(8) 16 Function Code Application

Use 16 Function code writes 4x 10 ~ 25 these 16 Words value.

In the HMI configuration to create a macro code: 16 function code. C, variables are defined as follows:

Data Type	Param name	PLC...	PLC Address type	Address	WordNum	OptMode	Array	Array Length
signed short	data	0	4X	10	1	Write	Yes	16

Code is as follows:

```

24 int MacroEntry()
25 {
26     short i;
27     for(i=0;i<16;i++)
28         data[i]=i+1;
29     return 0;
30 }
31
    
```

And then placed on a configuration screen "function key" component, the function is set to "execute macro code: 16 function code. C".

Running, click on the function keys on the HMI, the serial data received on debugging tools for the 01H 10H 00H 09H 00H 10H 20H 00H 01H 00H 02H 00H 03H 00H 04H 00H 05H 00H 06H 00H 07H 00H 08H 00H 09H 00H 0AH 00H 0BH 00H 0CH 00H 0DH 00H 0EH 00H 0FH 00H 10H 88H 37H.while serial debugging tools, the reply data 01H 10H 00H 09H 00H 10H 11H C7H.

The host (HMI) Request

Station no.	Function code	First address (High)	First address (Low)	Write Word Number (high byte)	Write Word Number (low byte)	Write Word Byte count	Data(1) High Byte	Data(1) low Byte
-------------	---------------	----------------------	---------------------	-------------------------------	------------------------------	-----------------------	-------------------	------------------

		byte)	byte)					
01	10	00	09	00	10	20	00	01

Data(3) High Byte	Data(3) low Byte	Data(4) High Byte	Data(4) low Byte	Data(5) High Byte	Data(5) low Byte	Data(6) High Byte	Data(6) low Byte	Data(7) High Byte	Data(7) low Byte
00	03	00	04	00	05	00	06	00	07

Data(8) High Byte	Data(8) low Byte	Data(9) High Byte	Data(9) low Byte	Data(10) High Byte	Data(10) low Byte	Data(11) High Byte	Data(11) low Byte	Data(12) High Byte	Data(12) low Byte
00	08	00	09	00	0A	00	0B	00	0C

Data(13) High Byte	Data(13) low Byte	Data(14) High Byte	Data(14) low Byte	Data(15) High Byte	Data(15) low Byte	Data(16) High Byte	Data(16) low Byte	CRC High Byte	CRC low Byte
00	0D	00	0E	00	0F	00	10	88	37

Slave (PLC) response

Station no.	Function code	First address (High byte)	First address (Low byte)	Write Word Number (high byte)	Write Word Number (low byte)	CRC High Byte	CRC low Byte
01	10	00	09	00	10	11	C7

14.5.3 MODBUS Protocol in the HMI Application

In the HMI interface design applications, often encountered need to design their own microcontroller control board communication situation. In this application environment, the MCU control system designers want a simple, stable and reliable means of communication with the HMI to exchange data. The MODBUS protocol is achieved between the HMI and the equipment master-slave communication mode most commonly used way.

Below microcontroller (hereinafter referred to as MCU) and HMI through MODBUS protocol (RTU transmission mode in case) communication, for example, explains how to use MODBUS protocol communication between the HMI and the MCU. Between the HMI and the MCU communication through MODBUS protocol mainly have the following two Master-slave ways:

Master / Slave	Using protocol	Advantage	Disadvantages
HMI as Master device MCU as Slave device	Modbus RTU	HMI direct access to the MCU mapped out 0X, 1X, 3X, 4X	MCU as a slave device must constantly respond to queries the HMI, CPU

		registers.	occupancy rate is high; MCU interrupt response shall be used, programming is relatively difficult.
HMI as Master device MCU as Slave device	Modbus RTU Slave	MCU as the master device can initiate communication; do not take up too much CPU time. HMI local address LW, LB is mapped to 4X, 0 X register, write or read by the MCU.	LW on the HMI configuration data is modified, you must regularly check the MCU can be read out to achieve them inconvenient. MCU can only access the HMI local word (LW), the position (LB)

(1) HMI as Master, MCU as Slave (using the Modbus RTU protocol)

MCU and HMI using standard Modbus RTU protocol for communication, HMI as master, MCU for the slave side, the MCU, you need to write the interrupt service routine to handle communication requests from HMI. MCU must support the standard Modbus RTU protocol, while MCU must map out 0X, 1X, 3X, 4X registers (where 0X, 1X is bit register; 3X, 4X for the word register)

The recommended communication parameter is 19200, data bits, 1 stop bit, no parity. In addition to seven data bits protocol support all settings other than combinations. Baud rate range from 1200-115200, with the flexibility to choose.

- Communication processes

First, HMI sends a request to the MCU, MCU accepts the request, a response back to the HMI. MCU can access the HMI, 4X, 3X, 0X, 1X register; the address range is 1 to 65535.



1. MODBUS protocol is relatively complex, demanding overtime
2. In the communication process, HMI continuously sends request packets to MCU; MCU accepts the request, the need to continue to give a response to the HMI. MCU's response is given using interrupt mode; therefore, MCU's CPU usage is high. Most of the MCU's CPU resources consumed during the communication response. Therefore, in practical applications need to be taken into account, if the MCU is used in addition to doing communication functions, there are other response functions, HMI (Master) MCU (Slave) using Modbus RTU protocol solution is not recommended, it is recommended to use HMI (Slave) MCU (Master), using Modbus RTU Slave protocol solutions

- HMI Power communication processes

When the HMI after power

(1) If the configuration page does not place any project component, the HMI will not send any communication packets External

(2) If the configuration page placed engineering components and these components address types are local types (LW, RW, RWI, LB, RB, RBI, LW.B), the HMI will not send any communication packets External

(3) If the configuration page to place the component works, and these elements are not the local address type for 0X, 1X, 3X, 4X, the HMI constantly scanning configuration page of these registers, and constantly sends communication data packets

(4) When using the timer device batch write bit components (consecutive addresses transmission number greater than one) when, HMI will be issued by the packet encapsulation function code: 0x0F

(5) When using the timer components word element bulk write (consecutive address transfer number greater than one) when, HMI will be issued by the packet encapsulation function code: 0x10

(6) Using recipes components download operation (that is, the local word register in HMI RW data downloaded to the MCU in the appropriate register, such as 4X).

When the download operation data length is greater than 1, HMI will be issued by the packet encapsulation function code: 0x10

- Data communications package

Assuming HMI configuration screen is placed 25 0X register address type, starting address: 20, HMI station number is 1.

HMI send packets: ("H" indicates hexadecimal form)

01H 01H 00H 13H 00H 25H XXH XXH (Wherein: "XX" indicates LRC / CRC)

MCU Return packets:

01H 01H 05H CDH 6BH B2H 0EH 1BH XXH XXH (Wherein: "XX" indicates LRC / CRC)

- HMI Communication parameter configuration

HMI Port parameter settings:

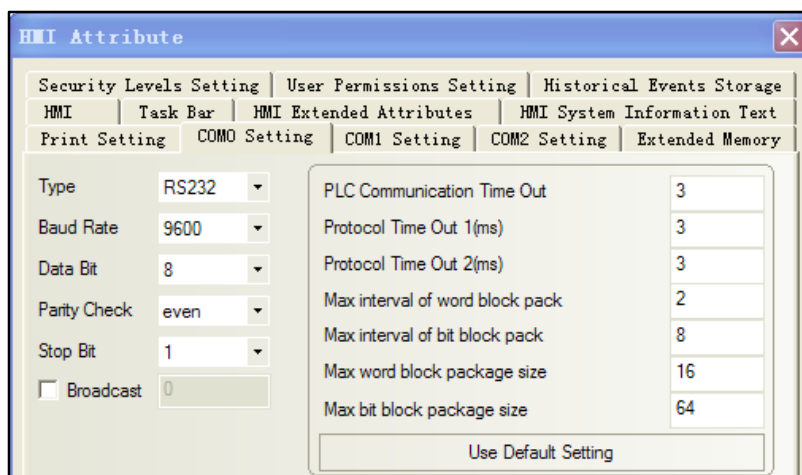

According to the actual physical connection mode selection set [Communication type].

Baud rate, data bits, parity, stop bits setting must be connected to the MCU and the corresponding parameters consistent.

Other parameters are described below:

Parameter	Explanation
PLC Communication timeout	HMI wait MCU response, if the MCU to set the time interval in which the response is not given, the HMI that communication timeout, and then continue to send request packet, continue to wait

Protocol timeout 1	<p>Inter-character timeout. HMI communication with the MCU in the process, if the communication frame characters and the time interval between characters exceeds the set time interval, the HMI think this communication process is completed, then, to deal with the communication data frame, parse packets.</p> <p>For Modbus protocol, baud rate calculation within the program should be based on an estimate. As follows:</p> $\text{Protocol timeout 1} = 1.5 * 1000000 * (1 + \text{data bits} + \text{parity} + \text{stop bits}) / \text{baud} + \text{set adjust time bps (baud rate)};$ <p>Sample code (standard C language):</p> <pre> int speed_arr[] = { B115200, B57600, B38400, B19200, B9600, B4800, B2400, B1200, B300, B150, B134, B110, B75 }; int name_arr[] = { 115200, 57600, 38400, 19200, 9600, 4800, 2400, 1200, 300, 150, 134, 110, 75 }; int adjust_time_bps_arr[] = { 1000, 4000, 10000, 11000, 25000, 40000, 70000, 140000, 600000, 0, 0, 0, 0 }; </pre> <p>Function: Set a baud rate adjustment values check time</p> <p>Parameter: baud_rate</p> <p>Returns: the current baud rate of the checksum time adjustment value</p> <pre> int set_adjust_time_bps(int baud_rate) { int adjust_time; int i; for(i=0; i<sizeof(speed_arr)/sizeof(int); i++) { if(baud_rate==name_arr[i]) { adjust_time=adjust_time_bps_arr[i]; break; } } return adjust_time; } </pre>
Protocol timeout 2	Reserved (users do not set)
Max interval of word (bit) block pack	Occurs mainly in the HMI read data phase, in order to improve communication efficiency, relatively tight group of registers connected to pack together to form a bulk read, for example, D1,

	D2, D4, group packet interval is set to 10, these three registers will be taken a bulk read (read from D1 from the bulk 4 registers). Note: The group packet interval must be less than the maximum length of batch read.
Max word (bits) block package size	Protocol supports the largest number of registers to read and write batch. This function is used to achieve data transmission components to achieve

PLC Station number setting:

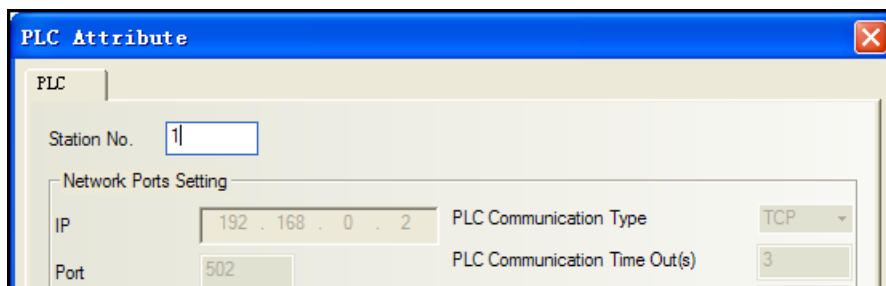

(2) MCU as Master, HMI as Slave (using Modbus RTU Slave protocol)

MCU and HMI using standard Modbus RTU protocol for communication, MCU for remote, HMI for the slave side, the MCU, just write a simple communication read / write programs without having to write the interrupt service routine. HMI local address LW, LB is mapped to 4X, 0X register, write or read by the MCU.

Registers the correspondence table is as follows:

Modbus Register address range	Local address range corresponding HMI
0X (1---9000)	LB (0---8999)
4X (1---9000)	LW (0---8999)

The recommended communication parameter is 19200, data bits, 1 stop bit, no parity. In addition to seven data bits protocol support all settings other than combinations. Baud rate range from 1200-115200, with the flexibility to choose from.

- Communication processes

First, MCU sends a request to the HMI, HMI accepts the request, a response back to the MCU.



1. MODBUS protocol is relatively complex, demanding overtime
2. In the communication process, MCU as the initiator of communication, initiate communication. When the HMI device accepts the request, a response back to the MCU. Therefore, MCU without constantly interrupt, do not take up too much CPU time
Therefore, in practice, if the MCU is used in addition to doing communication functions, there are other response functions (recommended to use this solution).
3. HMI configuration on LW, LB data is modified, you must regularly check the MCU can be read out and realize it is not very convenient. Therefore, the actual application, the MCU written communication read / write process, you should consider requesting the HMI data interval stated in the program to give much time to wait for a communication request

- HMI Power communication processes

In this scheme, the user edit the configuration project, the component type can only select local word address register LW and the local register LB. When powered on the HMI, HMI does not take the initiative to send out a packet communication, HMI is waiting to receive state. After the MCU send request, HMI resuming a response.

- HM Communication parameter configuration

HMI Port parameter settings:

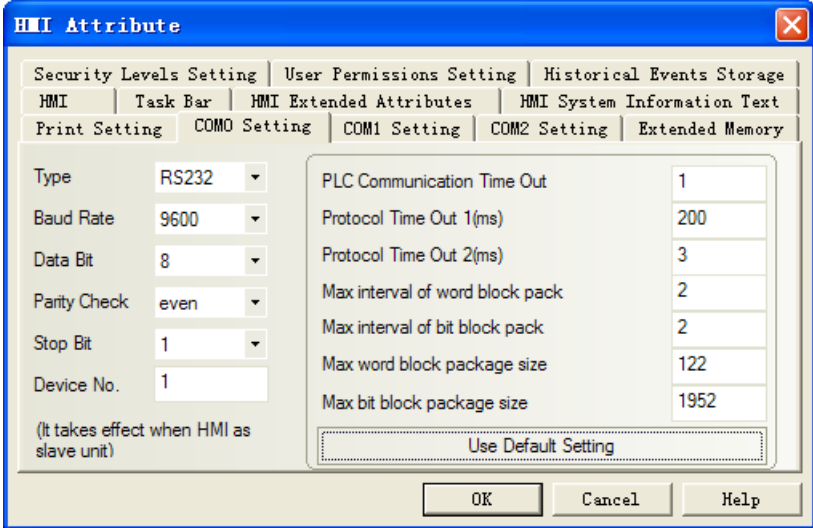

Them from the device number for the HMI station number, other communications parameters set according to specific circumstances.

15 VNC

VNC (Virtual Network Computing) is a kind of software for screen sharing and remote operation via RFB protocol. The VNC software could transfer mouse and keyboard operation and real-time screen.

VNC system is composed of client-side, server-side and protocol. The server side shares screen with client-side, while the client-side interacts with server side by monitoring and controlling server-side.

VNC is OS independent. Users could use the VNC system to remote control HMI via PC, mobile and so on.

15.1 Various client-sides

Kinco does not provide the VNC software. Users could download from the internet:

- VNC software for PC: VNC Viewer
- Browser: IE, Firefox...
- VNC software for mobile terminal: most mobile system support VNC software, for example: VNC/RDP.



1. JAVA plugin tool is required by browser access. Generally, PC has the JAVA plugin. Please refer to Java.com to install if there is no JAVA plugin on PC.
2. IF after install the JAVA plug-in, the browser to monitor HMI, JAVA plug-in can not run normally, you can change the security level to “Medium” in [Control Panel]-[All Control Panel Items].

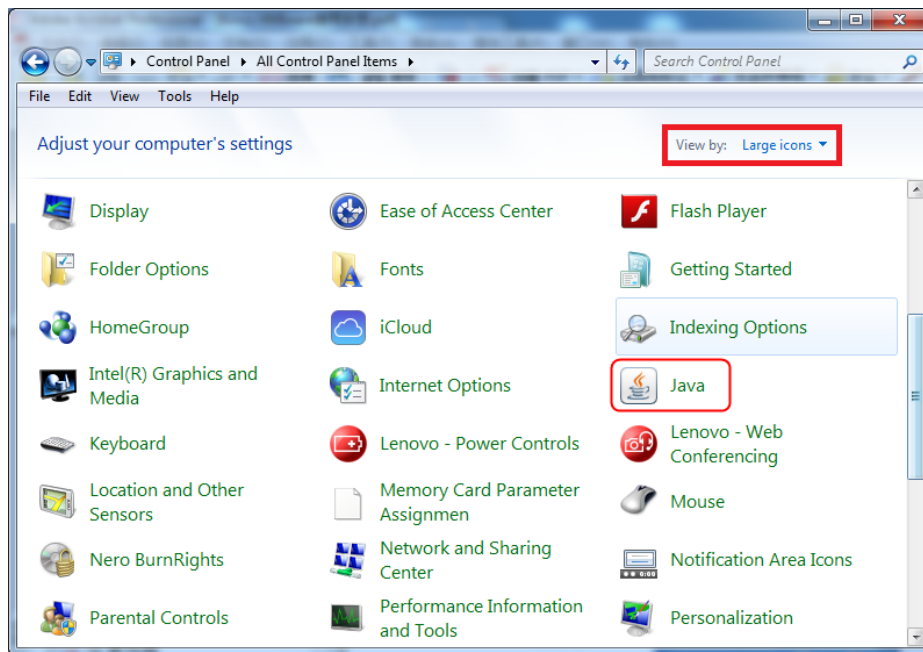

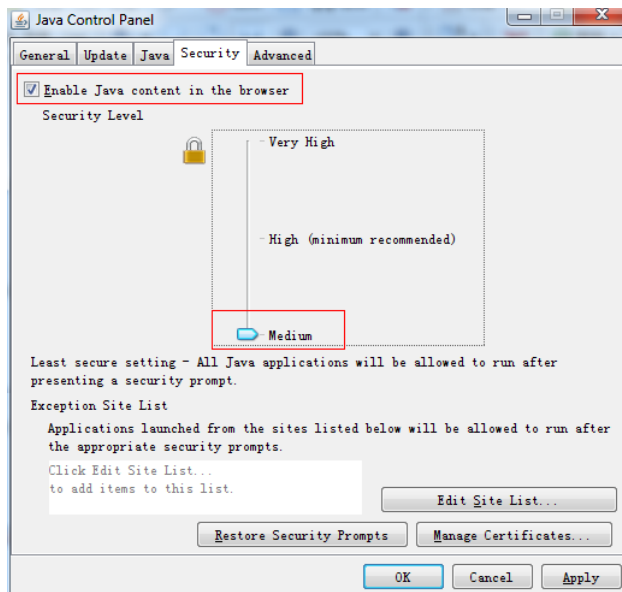

3. You can open multiple VNC Viewer clients to access to multiple HMI at the same time.

15.2 Access via LAN

15.2.1 Remote control HMI by PC via LAN

【Example 1】 Remote control MT4414TE by PC. MT4414TE works as server, while PC as client.



1. Only the HMI models with Ethernet port support VNC function for the VNC function is realized via Ethernet.

1) Tools required for Client-side:

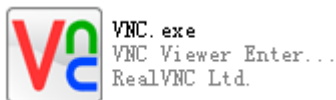

2) The related system registers of HMI are as follows:

Register	Function
LB9290	Open VNC function. Set to "1" to open the VNC function.
LB9291	Mask user operation. Set to "1" to mask user operation(check only, cannot operate)
LB9292	Operation password enabled. Set to "1" to enable operation password.
LB9293	Inquiry password enabled. Set to "1" to enable inquiry password.
LW10146~LW10147	Operation password
LW10148~LW10149	Inquiry password

3) Parameter settings for HMI:

Set IP of HMI as follows:

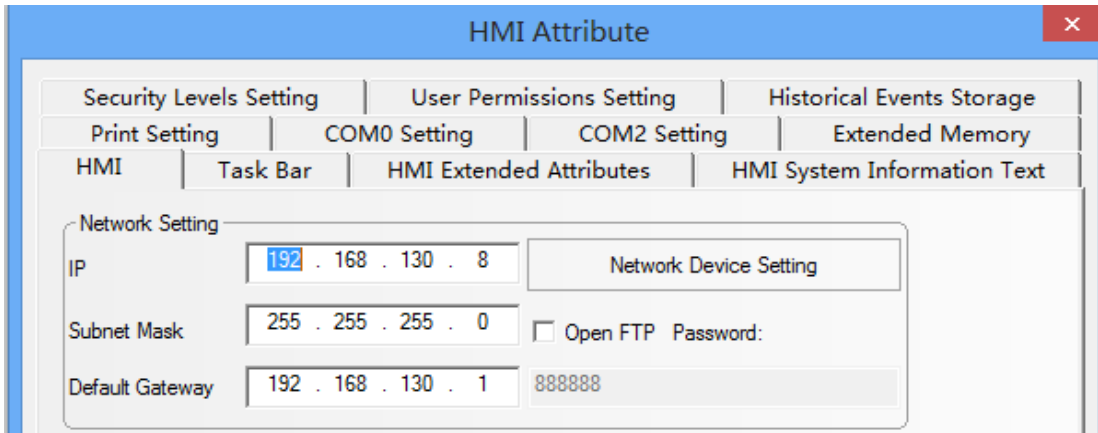

1. Take the default gateway in LAN.

Set the VNC related registers:

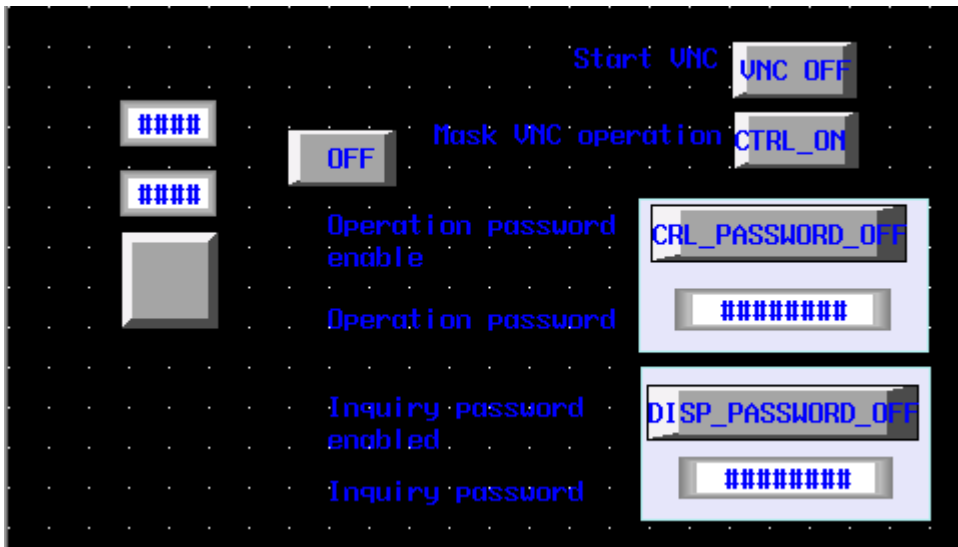

4) Parameter setting on PC

Input IP of the target HMI:

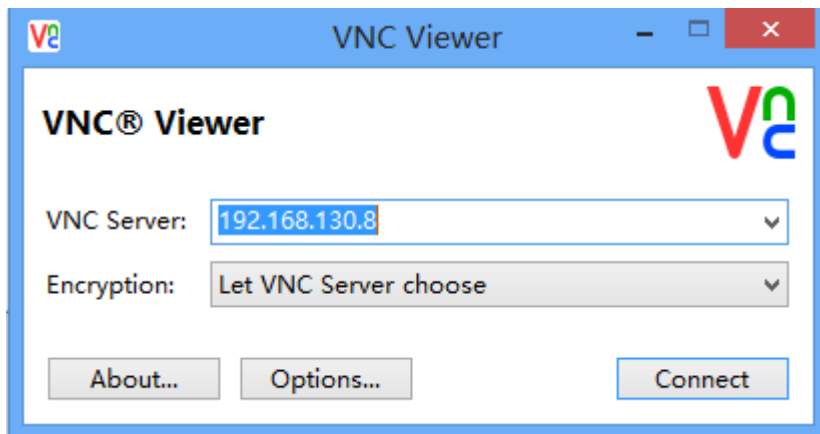

Input Password (Operation password or inquiry password)

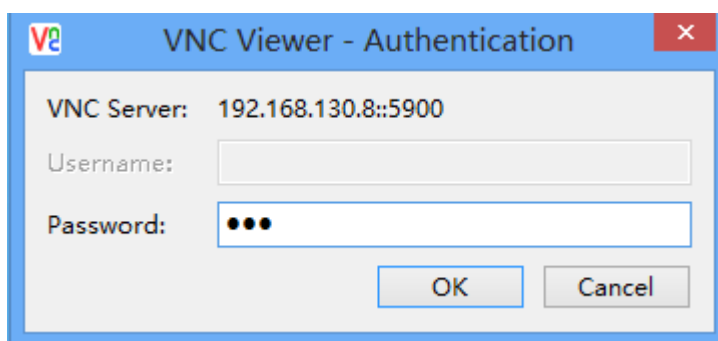

Monitoring on PC:

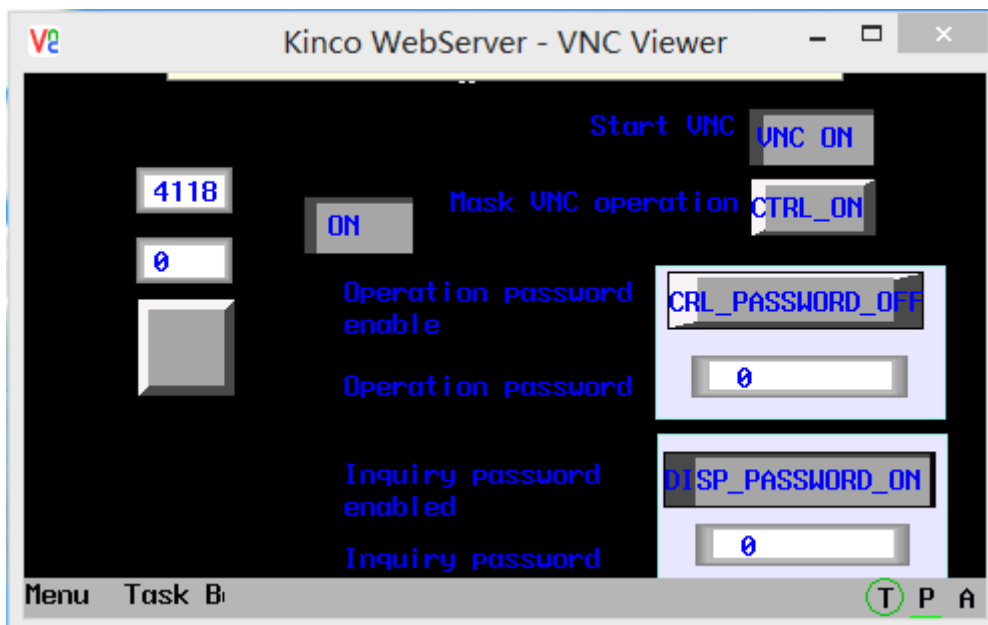

Changes on HMI is displayed on PC simultaneously, meanwhile, user could control HMI by operating on PC.



1. If input inquiry password on PC side, then users only could check HMI information, but cannot operate.
 2. If input operation password on PC side, then users could check HMI information and operate HMI on PC, but cannot operate.
 3. If there is no password set on HMI, then no passwords required for monitoring or operating HMI.
-

15.2.2 Remote control HMI by mobile via LAN

【Example 2】 Remote control MT4414TE by an android mobile. MT4414TE works as server, while the android mobile as client.

- 1) Tools required for mobile



- 2) Parameter setting of HMI is the same with 【Example 1】
- 3) Parameter setting on mobile



1. Input IP in the Address box.
 2. The default port is 5900, please do not change it, otherwise, may not get connection.
 3. Nickname and User name can be omitted.
 4. Input operation password or inquiry password.
-

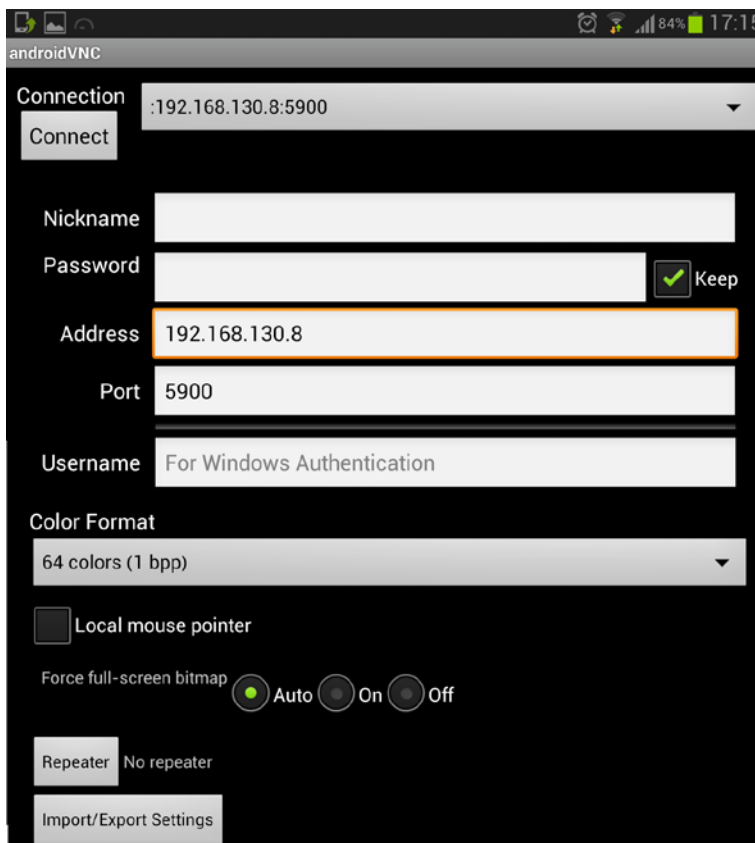

Monitoring on mobile:

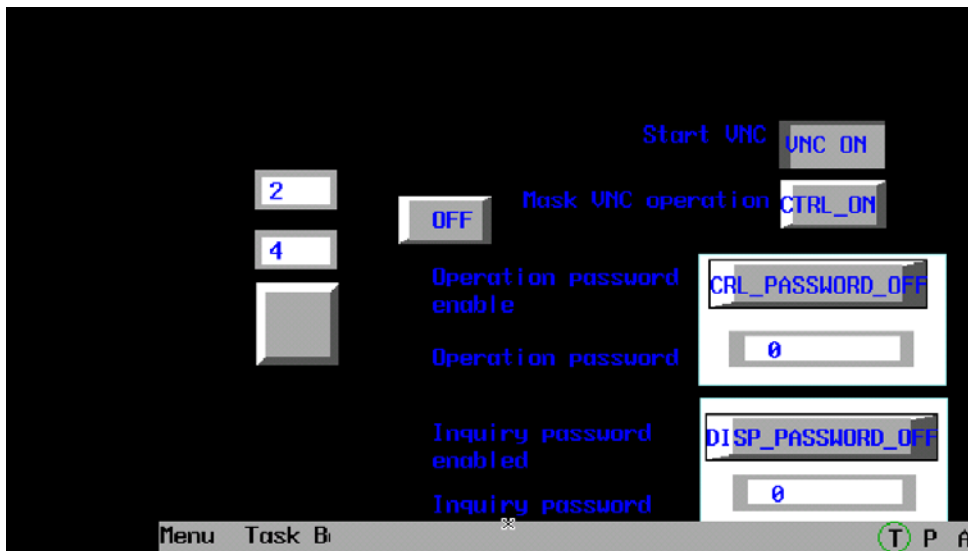

Changes on HMI is displayed on mobile simultaneously, meanwhile, user could control HMI by operating on mobile.

15.2.3 Remote control HMI by browser via LAN

【Example 3】 Remote control MT4414TE by browser.

- 1) Parameter setting of HMI is the same with **【Example 1】**
- 2) Open the browser, input IP and port of the target HMI in the website box: <http://192.168.130.8:5800>

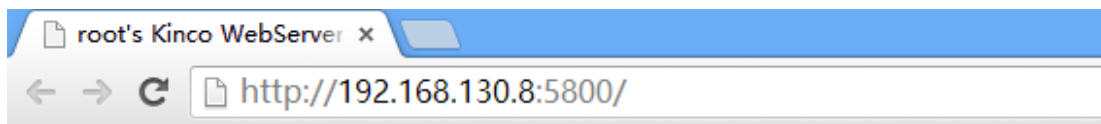

Input password (Operation password or inquiry password)

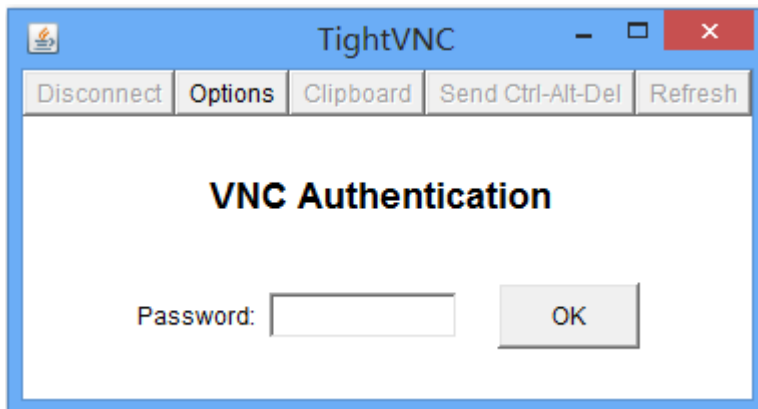

Monitoring by browser:

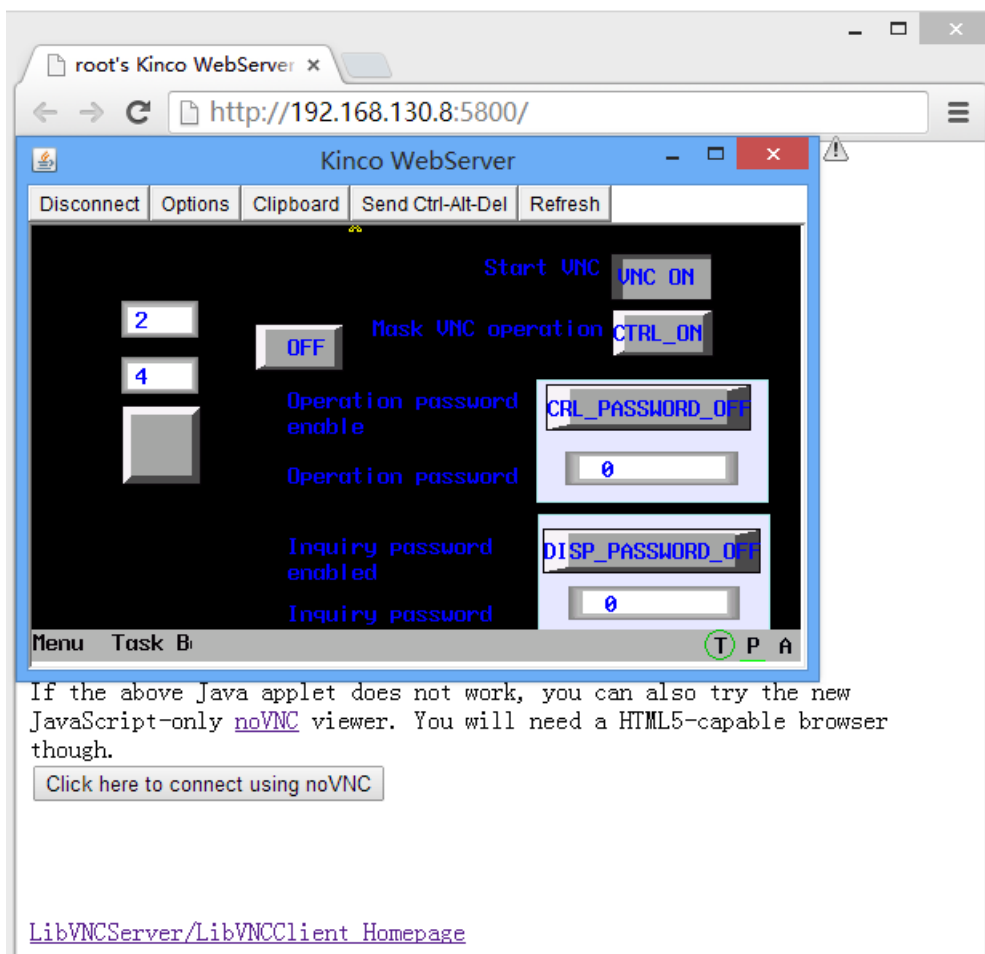

Changes on HMI is displayed by browser simultaneously, meanwhile, users could control HMI by operating on browser.



1. The remote control by browser is realized by a JAVA plugin running on the website. Please make sure that JAVA software has been installed on PC.
2. Default port for browser access is 5800. Please do not change it, otherwise may not get connection.
3. Only after updated kernel and Rootfs by v2.2 (build140314) software or above, the HMI can support the remote control by browser.

15.3 Access via WAN

For remote access via WAN, users need to set port mapping of HMI by router.

For remote access by VNC Viewer on PC via WAN, users need to map IP of target HMI to port number 5900.

【Example 4】 The IP of the remote HMI is: **192.168.4.39**

1) Port mapping: Choose menu “**Forwarding->Virtual Servers**” ,click the **Add New...** button

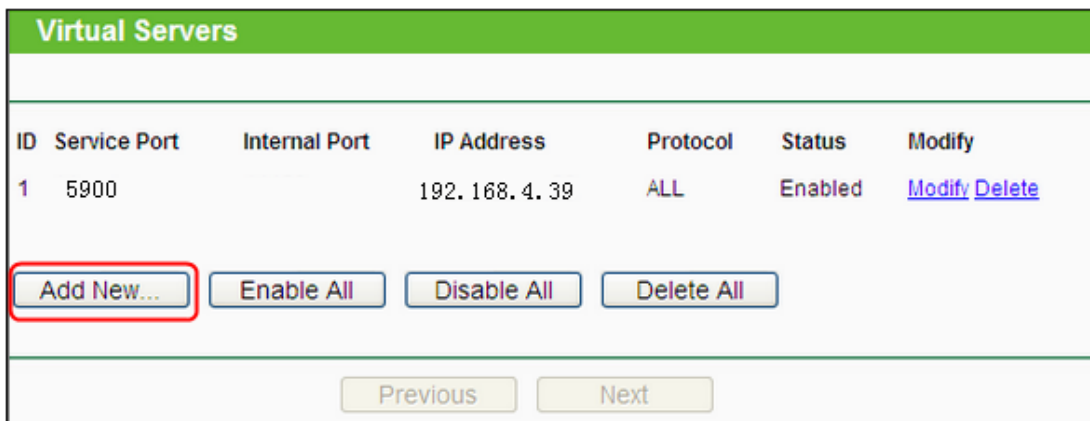

2) Parameter setting of HMI:

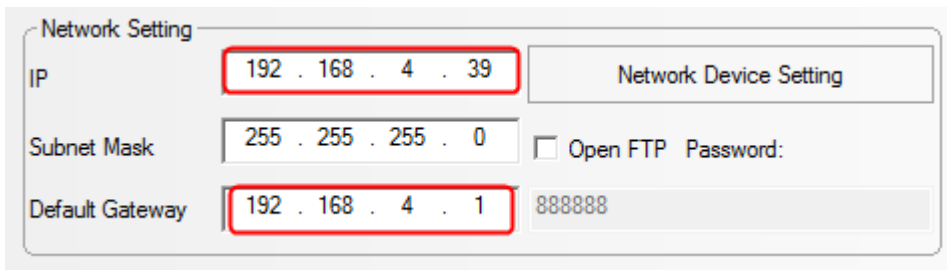

3) Assumed that the WAN IP of the local network where the HMI located is **192.168.100.14**, then, users need to input IP **192.168.100.14** into VNC Viewer and mobiles of external network to remote control HMI. Choose menu ”**Network->WAN**”

For remote access by browser via WAN, users need to map the HMI IP to port number 5800.

【Example 5】 The IP of the remote HMI is: 192.168.4.39

- 1) Port mapping: Choose menu “**Forwarding->Virtual Servers**” ,click the **Add New...**button

ID	Service Port	Internal Port	IP Address	Protocol	Status	Modify
1	5800		192.168.4.39	ALL	Enabled	Modify Delete

- 2) Parameter setting of HMI is the same with **【Example 4】**
- 3) Assumed that the WAN IP of the local network where the HMI located is 192.168.100.14, then, use the browser of the external network to visit website: <http://192.168.100.14:5800> to remote control HMI.



1. The Gateway must be set in the same network segment for access via WAN.
2. The firewall and antivirus software are suggested to be closed, for it may affect the VNC function.

Router mapping method: If the DMZ host is opened on PC, then users could remote control HMI by VNC without port mapping.

【Example 6】 The IP of the remote HMI is: 192.168.4.39

- 1) Router mapping: Choose menu “**Forwarding->DMZ**”

DMZ	
Current DMZ Status:	<input checked="" type="radio"/> Enable <input type="radio"/> Disable
DMZ Host IP Address:	<input type="text" value="192.168.4.39"/>
<input type="button" value="Save"/>	

- 2) Parameter setting of HMI is the same with **【Example 4】**
- 3) Assumed that the WAN IP of the local network where the HMI located is 192.168.100.14, then, users need to input IP 192.168.100.14 into PCs of external network to remote control HMI.

If users need to access multiple HMIs by VNC via WAN, then the router is required for supporting port self-definition of external network port. The model TL-WR841N (TP-LINK) supports port self-definition of external network.

【Example 7】 IP of remote HMI1 is 192.168.100.35, IP of remote HMI2 is 192.168.100.36.

- 1) Port setting of router: add two new items in [transfer rule]-[Virtual server]

Add or Modify a Virtual Server Entry	
Service Port:	<input type="text" value="5900"/> (00-255 or 256-65535)
Internal Port:	<input type="text" value="5900"/> (00, Only valid for single Service Port or leave it blank)
IP Address:	<input type="text" value="192.168.100.35"/>
Protocol:	All
Status:	Enabled
Common Service Port:	--Select One--
<input type="button" value="Save"/> <input type="button" value="Back"/>	

Add or Modify a Virtual Server Entry	
Service Port:	<input type="text" value="5901"/> (00-255 or 256-65535)
Internal Port:	<input type="text" value="5900"/> (00, Only valid for single Service Port or leave it blank)
IP Address:	<input type="text" value="192.168.100.36"/>
Protocol:	All
Status:	Enabled
Common Service Port:	--Select One--
<input type="button" value="Save"/> <input type="button" value="Back"/>	



1. For access by VNC Viewer, the internal port must be set to 5900 by router, and serve port can be set as casual value. Input IP and internal port for access by VNC Viewer via WAN.
2. For access by browser, the internal port must be set to 5800 by router, and serve port can be set as casual value. Input IP and internal port for access by

browser via WAN.

2) Parameter setting of HMI:

HMI1:

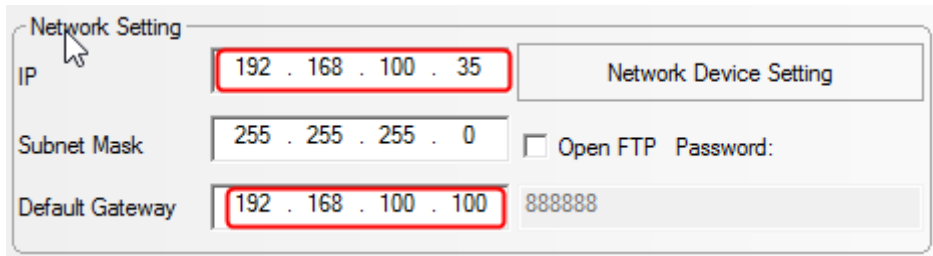

The screenshot shows the 'Network Setting' dialog box for HMI1. It contains the following fields: IP (192 . 168 . 100 . 35), Subnet Mask (255 . 255 . 255 . 0), and Default Gateway (192 . 168 . 100 . 100). There is also a 'Network Device Setting' button, an 'Open FTP' checkbox, and a 'Password' field with the value 888888.

HMI2:

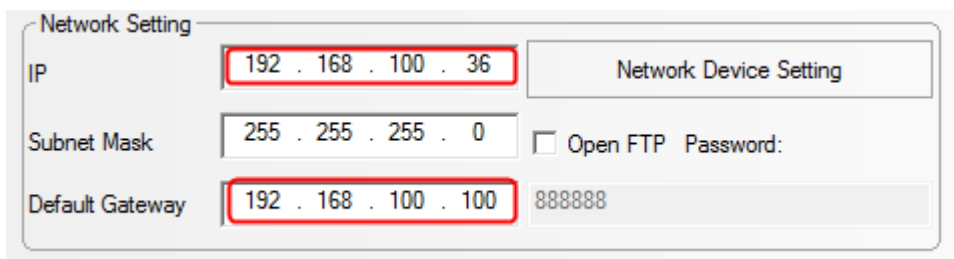

The screenshot shows the 'Network Setting' dialog box for HMI2. It contains the following fields: IP (192 . 168 . 100 . 36), Subnet Mask (255 . 255 . 255 . 0), and Default Gateway (192 . 168 . 100 . 100). There is also a 'Network Device Setting' button, an 'Open FTP' checkbox, and a 'Password' field with the value 888888.

3) Assumed that the WAN IP of the local network where the HMI located is 203.110.174.214, then, users need to input 203.110.174.214:5900 and 203.110.174.214:5901 into PCs and mobiles of external network to remote control HMI.



1. The firewall and antivirus software are suggested to be closed, for it may affect the VNC function.
-

16 Register

The registers supported by HMI include local registers and external PLC or the registers of control devices. Local registers include Local Word(LW), Local Bit(LB), Recipe Word(RW) and so on. External registers include M, D, S, etc.

16.1 Local Registers of HMI

16.1.1 Bit Address

Description	Address Type	Address Range	Format
Local bit, Local word address, local registers of HMI, don't save data after power off.	LB	0~9999	DDDD: Decimal system
Bit extended from local word, Bit addresses extended from local words.	LW.B	0~10255.F	DDDDD.H No. "H" bit of the no. DDDDD word, range of H: 0~f
Recipe bit, Recipe bit address, local registers of HMI, save data after power off, don't save data when run out of batteries.	RB	0~261000.F	DDDDDD.H
Recipe bit index, Recipe bit index addresses, indirect addressing mode is adopted, save data after power off, don't save data when run out of batteries.	RBI	0~261000.F	DDDDDD.H 【Example】RBI50 RB address=50+[LW9000]
Flash recipe bit, Flash recipe bit addresses, using FLASH to save the data that is Erased /Written infrequently, save data after power off even when run out of batteries, but the "erease/write"times are limited.	FRB	0~134217727.F	DDDDDDDD.H
Flash recipe bit index, Flash recipe bit index addresses, using FLASH to save the data that is Erased /Written infrequently, save data after power off even when run out of batteries, but the "erease/write"times are limited.	FRBI	0~134217727.F	DDDDDDDD.H

16.1.2 Word Address

Description	Address Type	Address Range	Format
Local word, Local word addresses.	LW	0~10255	DDDD

Recipe word , Local recipe word addresses, indicating the local register of HMI, save data after power off, don't save data when run out of batteries.	RW	0~261000	DDDDDD
Recipe word index , Recipe word index addresses, local register of HMI, indirect addressing mode is adopted, save data after power off, don't save data when run out of batteries.	RWI	0~261000	DDDDDD 【Example】 RWI50 RW address = 50 + [LW9000]
Extended Recipe word , Extended recipe word addresses, usually for HMI external storage devices access, such as SD card, U disk and so on, when more than one external storage devices are used, ERW0/ERW1/ERW2 will be used for indentifying.	ERW0~ERW2	0~2147483647	DDDDDDDDDD
Extended Recipe word index , Extended recipe word index addresses, usually for HMI external storage devices access, such as SD card, U disk and so on, when more than one external storage devices are used, ERW0/ERW1/ERW2 will be used for indentifying.	ERWI0~ ERWI2	0~2147483647	DDDDDDDDDD
Flash recipe word , Flash recipe word addresses, using FLASH to save the data that is Erased /Written infrequently, save data after power off even when run out of batteries, but the "Erease/Write" times are limited.	FRW	0~134217727	DDDDDDDDDD
Flash recipe word , Flash recipe word index address, using FLASH to save the data that is Erased /Written infrequently, save data after power off even when run out of batteries, but the "Erease/Write" times are limited.	FRWI	0~134217727	DDDDDDDDDD

16.2 System Special Registers of HMI

The system has reserved some Local Word(LW), Local Bit(LB) addresses for special purpose, the users must use the addresses according to related description.



When local registers are used, users need to pay special attention to making sure that the local registers cannot conflict with the special registers, otherwise the registers will not be able to be used normally or unexpected results will be lead.

16.2.1 Parameter Setting of Hardware

Address	Description	Read/Write
LB9018	Screen saver indication for entering. When the system enters screen saver/backlight and energy saving state, the bit is automatically set to ON; when the system exits screen saver state, it is set to OFF.	R
LB9019	Screen saver indication for exiting. When the system enters screen saver/backlight and energy saving state, the bit is automatically set to OFF; when the system exits screen saver state, it is set to ON.	R
LB9045	Restart touch screen. Restart HMI when this bit is set to ON.	W
LB9051	Enable/disable touch function when backlight is closed. Set this bit to ON will disable the touch function when backlight is closed.	R/W
LB9091	Increase LCD contrast. The system will execute the function of increasing LCD contrast by setting the bit to ON, upon completion, the bit will be cleared automatically.	W
LB9092	Decrease LCD contrast. The system will execute the function of decreasing LCD contrast by setting the bit to ON, upon completion, the bit will be cleared automatically.	W
LB9093	Increase backlight brightness. The system will execute the function of increasing backlight brightness by setting the bit to ON, upon completion, the bit will be cleared automatically.	W
LB9094	Decrease backlight brightness. The system will execute the function of decreasing backlight brightness by setting the bit to ON, upon completion, the bit will be cleared automatically.	W
LB9120	Trigger long sound of buzzer. Set the bit to ON to trigger long sound of buzzer once, upon completion, the bit will be cleared automatically.	W
LB9121	Trigger short sound of buzzer. Set the bit to ON to trigger short sound of buzzer once, upon completion, the bit will be cleared automatically.	W
LB9141	Turn off the current sound of buzzer alarm. Set the bit to On to turn off the current sound of buzzer alarm, upon completion, the bit will be cleared automatically.	W
LB9145	Automatically restart after system crash. Set the bit to ON, to make HMI will restart automatically after it crash for 5 seconds.	R/W
LB9160	Switch bit of CPU light. Set the bit to ON to turn off CPU light, and forbid blinking.	R/W
LB9163	Screen flip display. Set the bit to ON to flip vertical display the HMI screen.	R/W
LB9401	Mask buzzer for event and alarm. Set this bit to ON to close buzzer; Set this bit to OFF to open buzzer.	R/W

LW9140	Display screen brightness level.	R
LW9141	Display screen contrast level. Note: as for KM5303, the value of LW9141 indicates the brightness of the buttons.	R
LW9464	Audio volume register. Range: 0~100, 0 indicates mute, from 1 to 100, the volume increases gradually.	R/W
LW9532	Number of the screen saver window. Display and set the number of the screen saver window.	R/W

16.2.2 System Setting

● System parameter Setting

Address	Description	Read/Write
LW10010	Initial window number, range: 0~65535.	R/W
LW10011	Screen saver/backlight and energy saving time setting. 0: Disable screen saver; 1~65535: Enable screen saver (take effect without restart). Time unit: minute.	R/W
LW10012	Buzzer sound. 0: Disable; 1: Enable (take effect without restart, non-zero value enables the function) Note: LW10012 is only used for closing buzzer, not for closing the buzzer sound triggered by alarms and events. For the buzzer sound triggered by alarms and events, the function is prohibited.	R/W
LW10013	Pop-up window attribute. 0: Normal; 1: Display above other windows.	R/W
LW10014	Common window attribute. 0: Display below base window; 1: Display above base window.	R/W
LW10015	Number of stored events. Range: 0~65535	R/W
LW10017	Default language. Range: 0~7.	R/W
LW10018	System reserved. For HMI internal use.	R/W
LW10019	Exchange communication ports. Set the bit to ON to exchange com0 and com1 of HMI.	R/W

● Taskbar control

Address	Description	Read/Write
LB9040	Hide/display Fast selection window. Set the bit to ON to hide; Set the bit to OFF to display.	R/W
LB9041	Hide/display taskbar. Set the bit to ON to hide; Set the bit to OFF to display.	R/W
LB9042	Hide/display task buttons. Set the bit to ON to hide; Set the bit to OFF to display.	R/W
LB9043	Hide/display all (Fast selection window, taskbar, task buttons). Set the bit to ON to hide; Set the bit to OFF to display.	R/W

● Keyboard control

Address	Description	Read/Write
LB9060 LB9061	Keypad popup indication. Keypad popup is controlled by the component in the left part of the window. When numeric input or text input function is enabled by users, HMI will set the bit to	R

	ON automatically, and pop up a direct window including a keypad. After successful entry or pressing [Esc], this bit will be set to OFF, and the keypad window will be closed automatically.	
LB9062	Keypad popup indication. Keypad popup is controlled by the component in the upper left part of the window.	R
LB9063	Keypad popup indication. Keypad popup is controlled by the component in the bottom left part of the window.	R
LB9064 LB9065	Keypad popup indication. Keypad popup is controlled by the component in the right part of the window.	R
LB9066	Keypad popup indication. Keypad popup is controlled by the component in the upper right part of the window.	R
LB9067	Keypad popup indication. Keypad popup is controlled by the component in the bottom right part of the window.	R
LB9068 LB9069	Keypad popup indication. Keypad popup is controlled by the component in optional position of the window.	R
LB9080	Keypad popup indication. Keypad popup is controlled by the component in the upper half part of the window.	R
LB9081	Keypad popup indication. Keypad popup is controlled by the component in the bottom half part of the window.	R

● **Pinyin input method**

Address	Description	Read/Write
LB9100	This bit is used to switch input method of Chinese and English. When the bit is set to ON, the system switches to Pinyin input method; when it is set to OFF, the system switched to English input method.	R/W
LW9150	The value is the serial number of the current window in which Chinese characters are displayed, the value is used for page turning.	R/W
LW9152~9167	Display the currently entered Pinyin characters.	R

● **Touch**

Address	Description	Read/Write
LB9053	Touch status. The bit will be set to ON when press, OFF when lose.	R
LW9030	Touch coordinate. Record the touch coordinate of X position that takes the upper-left corner of the screen as origin.	R/W
LW9031	Touch coordinate. Record the touch coordinate of Y position that takes the upper-left corner of the screen as origin.	R/W
LW9540	Position of the touch component (component position). The values are the coordinates (x, y, w,	R

~9543	h) of the touch component relative to the window coordinates.	
LW9544 ~9547	Position of the window which the touch components are in (window position). The values are the coordinates (x, y, w, h) of the window which the touch components are in relative to the screen coordinates.	R

● **Cursor**

Address	Description	Read/Write
LB9135	Cursor lock. When the bit is set to ON, the cursor is locked in the current input component, it will switch to other input components only after the current input is completed.	R/W
LW9520	Cursor position. X position of the cursor in the input component.	R
LW9521	Cursor position. Y position of the cursor in the input component.	R
LW9530	Cursor semi-transparent display. When the value are not set to 0,the cursor will display semi-transparently, the range of the value is 20~100.	R/W

● **Change Base Window**

Address	Description	Read/Write
LB9052	Disable the return value function of 【PLC Control】 — 【Change Base Window】 . ON: Disable; OFF: Enable. 【Example】 : To switch from Base Window 10 to Base Window 12 with the 【PLC Control】 — 【Change Base Window】 function, and the reading address is D12, the switchover will be implemented when the value of D20 is 12. After the system switches to Base Window 12, PLC will automatically return the number 12 to the address D21. If the return value function is disabled, the system will not return the number 12 to D21.	R/W
LB9139	The bit will be set when change Base Window. The bit will be set to ON when change Base Window display.	R
LW9050	Displaying Base Window Number. Slave machine can maintain the same Base Window with master machine according to the word.	R

● **Print control**

Address	Description	Read/Write
LB9016	Printer error indication. The bit is set to ON in case of printer error and to OFF if printer is normal.	R
LB9017	Printer control. Set it to ON to disable print function; set it to OFF to enable print function. Note: 【HMI Attributes】 — 【print Setting】 — 【Enable print】 must be selected, otherwise the function of this bit will be invalid.	R/W
LB9123	Event printing setting. Set the bit to ON to separate event content from other information such as serial number, time and so on.	R/W

LB9132	Printing indication. The bit will be set to ON when printing, OFF when finished.	R
LB9133	Printing preprocessing. Set the bit to ON to execute printing preprocessing operation to improve the printing results.	R/W
LB9143	USB printer connection status. Set the bit to ON for connection, OFF for disconnection.	R
LB9202	Print header of History Data. Set the bit to ON to always print header; OFF to print only once.	R/W
LW9800	Error code register, word length:2	R
LW10254	Enable Pictbridge print. Set it to 1 to enable pictbridge print; set it to 0 to disable pictbridge print.	R/W

● **HMI System Version Information**

Register	Description	Read/Write
LW9640	Hardware Version	R
LW9641	Kernel Version	R
LW9642	Rootfs Version	R
LW9643	GUI Version	R
LW9644	Comserver Version	R
LW9645	Servo Version	R

● **HMI Time**

Address	Description	Read/Write
LW9034~9035	Stopwatch, double word, display the time in unit of 0.1 second.	R
LW10000	BIN code, System time (Second), range:0~59	R/W
LW10001	BIN code, System time (Minute), range:0~59	R/W
LW10002	BIN code, System time (Hour), range:0~23	R/W
LW10003	BIN code, System time (Date), range:0~31	R/W
LW10004	BIN code, System time (Month), range:0~12	R/W
LW10005	BIN code, System time (Year), range:0~9999	R/W
LW10006	BIN code, System time (Week), range:0~6	R/W



The system time should be downloaded into HMI for debugging, it will call the system time of PC when run in offline simulation mode on PC.

● **External time**

Address	Description	Readable/Writable
LW9010	Local time(Second), Range:0~59	R/W
LW9011	Local time(Minute), Range:0~59	R/W
LW9012	Local time(Hour), Range:0~23	R/W

LW9013	Local time(Date), Range:0~31	R/W
LW9014	Local time(Month), Range:0~12	R/W
LW9015	Local time(Year), Range:0~9999	R/W
LW9016	Local time(Week), Range:0~6	R/W
LW9017	Local time(Millisecond), Range:0~999	R/W



1. When **【HMI Attributes】** — **【Use The External Clock for Event】** is selected, the events will read the values of LW9010~9017 rather than adopt system time of HMI.
2. Before this function is used, the values of PLC time registers must be transmitted to LW9010~9017.

● VNC

Address	Description	Read/Write
LB9290	VNC enable, set on, start VNC function	R/W
LB9291	VNC operation disable, set on, no VNC operation	R/W
LB9292	VNC operation password enable, set on, password valid	R/W
LB9293	VNC check password enable, set on, password valid	R/W
LW10146~10147	VNC operation password	R/W
LW10148~10149	VNC check password	R/W

● Two-dimensional code function

Address	Description	Read/Write
LW9680	Set the character input address	R/W
LW9681	Set the address of two-dimensional code display	R/W
LW9683	Set the image size of two-dimensional code	R/W
LB9421	Produce two-dimensional code	R/W



1. Must use Freeplotting to show two-dimensional code;
2. The size of freeplotting must be same as the value of LW9683;
3. Here we use indirect addressing because of shortage of LW. We use LW9680 to point to input address. For example, LW9680=1000, input address LW1000. We use LW9681 to point to output address. For example, LW9681=2000, Output address LW.B2000.

● Others

Address	Description	Read/Write
LB9124	Times of alarm setting. Set the bit to ON to display alarm times in the front of the messages.	R/W
LB9162	TTF font optimization display. Set the bit to ON to optimize the display effect of the edge of the TTF font.	R/W
LB9164	Video mode selection. ON: NTSC mode; OFF: VPAL mode.	R/W

LB9240	ON: When the number input component which read address same as write address is input ENT, the new value will display immediately.	R/W
LB9260	Speed selection switch pages. ON: Switch page displays fast. OFF: Switch page displays slow.	R/W
LB9261	Switch page data display selection. ON:Keep original data. OFF:Page data first brush cut to zero, and then display valid data.	R/W
LB9270	Open the function of exporting event to csv file including date. ON:Open.After setting ON,the format of csv file in external device(USB,SD Card)will change,it can't be used together with the function "Save to external device" like USB and SD Card. OFF: Close.	R/W
LB9280	Identifier bit of unconfirmed event. ON: there are events which are unconfirmed; OFF: there is no event which is unconfirmed.	R/W
LB9281	ON: confirm all events.	R/W
LB9910	Open WebServer. Set the bit to ON to open WebServer function; while OFF to close this function.	R/W
LB9911	Browser display mode. Set the bit to ON to display HMI image with gray mode in browser; while OFF to display actual HMI image.	R/W
LW9616	Record the current number of events triggered. Word length:1	R/W
LW9370	Operation acknowledgement mode. Operator acknowledgement mode: 1: Confirm; 2: Cancel.	R
LB9915	Set on, with key, KM5303 switch disable	RW
LB9920	Set on, instead invalid float number NAN of former value	RW



1. The above functions will take effect after restart.
2. The values of the local words above will be saved after power off.

16.2.3 Components Setting

● Input Components

Address	Description	Read/Write
LB9129	Trigger input components in basic window. Set the bit to ON to trigger input components in basic window.	W
LB9131	Input components trigger automatically. Set the bit to ON to make the input components triggered automatically after open window.	R/W
LB9140	Caps Lock. Set the bit to ON to make English letters input in capital format; the bit will be set to OFF automatically after input finished.	R/W
LB9142	Trigger input components in popup window. Set the bit to ON to trigger input components in the popup window in top layer.	W

LB9161	Components left alignment display. Set the bit to ON to make the display component(LW9060~9075) on the keyboard displays left alignment when input.	R/W
LW9002 ~9003	Display the maximum of numeric input. When numeric input component is activated, it will display the maximum of the numeric component. Otherwise, it will be set to 0.	R
LW9004 ~9005	Display the minimum of numeric input. When numeric input component is activated, it will display the minimum of the numeric component. Otherwise, it will be set to 0.	R
LW9060 ~9075	Number/Text input procedure display. The words will display the input procedure when Number/Text input components are activated. LW9075 display the latest input data. Usually text components are used for displaying.	R
LW9180 ~9187	Display the maximum of number input, usually by text components.	R/W
LW9190 ~9197	Display the minimum of number input, usually by text components.	R/W
LW9380 ~9395	Display the historical data of number input components, usually by text components.	R

● **Text components**

Address	Description	Read/Write
LB9137	Display the bytes of text display component in inverted order. Set the bit to ON, then the high bytes and low bytes of text component will exchange to display, the low bytes will display on the right side of the text component.	R/W
LB9138	Mask text characters. Set the bit to ON to make text component only display characters in code 33~127. Other characters will be replaced by space character.	R/W
LB9410	Set the bit to ON, the lack bit display 0; otherwise the lack bit display space. Default: Off	R/W
LB9411	Set the bit to ON,clear content before input. Otherwise no action.	R/W
LW9130	Switch text library contents online. The value indicates the text library index.	R/W
LW9170	Display the page number of note book component. The value indicates the initial row of the input area. It is used for page turning of note book component.	R

● **Trend Curve**

Address	Description	Read/Write
LB9110	Active view and zoom function of trend curve.	R/W
LB9111	Active cursors function of trend curve.	R
LW9200	Time value of the browsed points of trend curve, year. BIN code.	R
LW9201	Time value of the browsed points of trend curve, month. BIN code.	R
LW9202	Time value of the browsed points of trend curve, date. BIN code.	R

LW9203	Time value of the browsed points of trend curve, hour. BIN code.	R
LW9204	Time value of the browsed points of trend curve, minute. BIN code.	R
LW9205	Time value of the browsed points of trend curve, second. BIN code.	R
LW9210~	Display the value of every channel of every browsing dot in trend curve. According to the channels of trend curve, the registers will display the current value of each channel. LW9210 displays the value of channel 0; LW9211 displays the value of channel 1; ...	R

- Register decoding in Modbus Slave driver

Address	Descriptions				R/W
LW9810	Adjust the decoding sequence of 16bits integer				R/W
	Value	Sequence	Descriptions	For example:0x0001	
	0	12	High byte and low byte are normal	Means 1 (0x0001)	
	1	21	High byte and low byte swap	Means 256 (0x0100)	
LW9811	Adjust the decoding sequence of 2bits integer				R/W
	Value	Sequence	Descriptions	For example:0x0000 0001	
	0	1234	High byte and low byte,high word and low word are Normal	Means 1 (0x0000 0001)	
	1	2143	High word and low word are normal,but high byte and low byte swap.	Means 256(0x0000 0100)	
	2	3412	High word and low word swap,but high byte and low byte are normal.	Means 65536 (0x0001 0000)	
	3	4321	High word and low word,high byte and low byte swap.	Means 16777216 (0x0100 0000)	
LW9812	Adjust the decoding sequence of 2bits float				R/W
	Value	Sequence	Descriptions	For example:0x3F80 0000	
	0	1234	High byte and low byte,high word and low word are Normal	Means 1.0(0x3F80 0000)	
	1	2143	High word and low word are normal,but high byte and low byte swap.	Means -5.78564e-039 (0x803F 0000)	
	2	3412	High word and low word swap,but high byte and low byte are normal.	Means 2.27795e-041 (0x3F80 0000)	
	3	4321	High word and low word,high byte and low byte swap.	Means 4.60060e-041 (0x0000 803F)	

16.2.4 Security Level and User Permission

- Security Level

Address	Description	Read/Write
LB9046	Lower security level. The bit will be set to ON when system switches from a lower security level to a higher level.	R
LW9040~9041	Password of security level. Double word.	W
LW9042	Security level. Display security level of current base window.	R

LW9043	Switch security level by force. Force to switch from higher level (for example, level 2) to lower level (for example, level 0).	W
--------	---	---

● **Mapping of Security Level**

Address	Description	Read/Write
LW10024~10025	Level 1 password. Double word	R/W
LW10026~10027	Level 2 password. Double word	R/W
LW10118~10119	Level 3 password. Double word	R/W
LW10120~10121	Level 4 password. Double word	R/W
LW10122~10123	Level 5 password. Double word	R/W
LW10124~10125	Level 6 password. Double word	R/W
LW10126~10127	Level 7 password. Double word	R/W
LW10128~10129	Level 8 password. Double word	R/W
LW10130~10131	Level 9 password. Double word	R/W
LW10132~10133	Level 10 password. Double word	R/W
LW10134~10135	Level 11 password. Double word	R/W
LW10136~10137	Level 12 password. Double word	R/W
LW10138~10139	Level 13 password. Double word	R/W
LW10140~10141	Level 14 password. Double word	R/W
LW10142~10143	Level 15 password. Double word	R/W



1. The value of the local word above could be saved after power off.
2. Online modification of passwords is supported by the function.
3. Passwords could be modified online, while offline simulation does not support passwords modification.

● **User Permission**

Address	Description	ReadWrite
LB9165	User login. Set ON to execute logining operation, then set OFF automatically.	W
LB9166	User logoff. Set ON to execute logoff operation, then set OFF automatically.	W
LB9167	Add user. Set ON to execute adding user operation, then set OFF automatically.	W
LB9168	Delete user. Set ON to execute deleting user operation, then set OFF automatically.	W
LB9169	Modify password. Set ON to modify password operation, then set OFF automatically.	W
LB9190	Executive mark of user management. The bit will set to ON when execute operations of Add/Delete users.	R
LB9191	Operation failure of user management. The bit will be set to ON when operation of user	R

	management fails.	
LW9486~9501	User name for login. Input user name for login, 32 characters at most.	R/W
LW9502~9503	User password. Input user password for login.	R/W
LW9504~9505	Display user permission of the current user. Display the user permission with 32 bits corresponding to the current user.	R
LW9506~9507	Set user permission. Set user permission with 32 bits when adding user information.	W
LW9508~9509	Set automatic logoff time. Set automatic logoff time when adding user information.	W
LW9510~9511	Password confirmation. Input password again to confirm the consistency when adding user information.	W
LW9650~9665	Display login user name	R

16.2.5 Data and Project Management

Recipe operation

Address	Description	Read/Write
LB9010	Recipe downloading indication. The bit will be set to ON in downloading status, and set to OFF automatically after download is finished (Download from recipe to PLC).	R
LB9011	Recipe uploading indication. The bit will be set to ON in uploading status, and set to OFF automatically after uploading is finished (Upload from PLC to recipe).	R
LB9012	Recipe Download/Upload indication. Set to ON in downloading/uploading status, and set to OFF automatically after downloading/uploading is finished.	R
LW9000~9001	Index address for recipe data. RWI and RBI access recipe data by this index address. LW9000 is low word, LW9001 is high word.	R/W
LB9130	Clear RW register. Set the bit to ON to trigger RW clearance.	R/W
LW9260~9261	Initial address for RW clear operation.	R/W
LW9262~9263	Word length for RW clear operation.	R/W

● External memory operation

Address	Description	Read/Write
LB9153	Safety removing setting of SD card. Set the bit to ON before inserting SD card; Set to OFF before removing to make sure safety removing.	R/W
LB9154	Safety removing setting of U disk 1. Set the bit to ON before inserting U disk 1; Set to OFF before removing to make sure safety removing.	R/W
LB9155	Safety removing setting of U disk 2. Set the bit to ON before inserting U disk 2; Set to OFF before removing to make sure safety removing.	R/W
LB9156	Clear files in SD card. Clear all the files that generated in SD card.	W
LB9157	Clear files in U disk 1. Clear all the files that generated in U disk 1.	W
LB9158	Clear files in U disk 2. Clear all the files that generated in U disk 2.	W

LB9220	HMI is reading SD card indication. ON: reading operation	R
LB9221	HMI is reading U disk1 indication. ON: reading operation	R
LB9222	HMI is reading U disk2 indication. ON: reading operation	R
LB9230	HMI is writing SD card indication. ON: writing operation	R
LB9231	HMI is writing U disk1 indication. ON: writing operation	R
LB9232	HMI is writing U disk2 indication. ON: writing operation	R
LW9470~9485	Prefix title of the copied file. Prefix character strings of the file name which is copied to SD card or U disk.	R/W

● **File list box operation**

Address	Description	Read/Write
LB9150	Execute import/export operation of project or recipe. Set the bit to ON to execute import/export operation.	W
LB9151	Protection bit of export project. Uploading password is input correctly when export project, then the bit will be set to OFF, otherwise, it will be set to ON.	R
LB9152	Switch folder type between tree type and list type. Set the bit to ON to display folders in tree type, while set it to OFF to display folders in list type.	R/W
LB9265	Open import/export logo function.ON: Open import/export logo function. OFF: Open import/export project function.	R/W
LW9300~9331	Route name of the browsed file. Display the route name which is browsed currently in file list component.	R
LW9332~9363	Current selected file. Display the file name which is browsing currently in file list component.	R/W
LW9364	Import/ export selection of project or recipe. 1: project import; 2: project export; 3: recipe import; 4: recipe export.	R/W
LW9366	Copy/cut/ paste operation of files. With file browse component to execute: 1: copy; 2: cut; 3: paste.	W

16.2.6 Communication

● **PLC communication information**

Address	Description	Read/Write
LB9136	Filtrate communication of the non-response PLC. Set the bit to on to filtrate communication of the non-response PLC.	R/W
LB9144	Hide the component which failed in communication. Set the bit to ON to hide the component which failed in communication.	R/W
LB9180	Notification bit of PLC access error, when PLC communication error occurs, the bit will	R

	be set to ON.	
LW9264~9279	Mask off code of PLC station NO. (COM port 0). Each bit corresponds to one station no. of port 0 (9264.0 corresponds to station no. 0, ... , 9279.F corresponds to station no. 255), set the corresponding bit to ON to mask the communication of the corresponding station.	R/W
LW9280~9295	Mask off code of PLC station NO. (COM port 1). Each bit corresponds to one station no. of port 1 (9280.0 corresponds to station no. 0, ... , 9295.F corresponds to station no. 255), set the corresponding bit to ON to mask the communication of the corresponding station.	R/W
LW9400~9415	Mask off code of HMI no.. Each bit corresponds to one HMI no. in the network (9400.0 corresponds to HMI no. 0, ... , 9415.F corresponds to HMI no. 255), set the corresponding bit to ON to mask the communication of the corresponding HMI.	R/W
LW9432~9447	Register for communication status indication (COM 0). Each bit corresponds to one station no. (9432.0 corresponds to station no. 0, ... , 9447.F corresponds to station no. 255). When PLC communication timeout and no response, the corresponding bit will be set to ON, otherwise, the bit will be set to OFF.	R/W
LW9448~9463	Register for communication status indication (COM 1). Each bit corresponds to one station no. (9448.0 corresponds to station no. 0, ... , 9463.F corresponds to station no. 255). When there is no response and PLC communication timeout, the corresponding bit will be set to ON, otherwise, the bit will be set to OFF.	R/W
LW9296~9299	Mask off code of error message. Each bit corresponds to one error message. Set the bit to ON to mask the corresponding error message indication. For example: "PLC No Response" corresponds to 9296.2, "Socket Connect Error" corresponds to 9296.4	R/W
LW9550~9553	Indication code of error message. Each bit corresponds to one error message, when an error indication occurred, the corresponding bit will be set to ON automatically. For example : "PLC No Response" corresponds to 9550.2 , "Socket Connect Error" corresponds to 9550.4	R

● **Mapping of communication parameters**

Address	Description	Read/Write
LW10030~10033	IP address. Each section occupies one word, range 0~255.	R/W
LW10034	Download port number. It is download port number rather than communication port number.	R/W
LW10035	Reserved.	R/W
LW10110	Gateway. Each section occupies one word, range 0~255.	R/W

LW10114	Subnet mask. Each section occupies one word, range 0~255.	R/W
LW10036	Work mode of COM0. 0: 232; 1: 485-4w; 2: 485-2w	R/W
LW10037~10038	Baud rate of COM0. Double word..	R/W
LW10039	Data bit of COM0.	R/W
LW10040	Check bit of COM0.	R/W
LW10041	Stop bit of COM0.	R/W
LW10042	Slave station no. of COM0 (HMI station no.)	R/W
LW10043~10044	PLC time-out constant of COM0.	R/W
LW10045~10046	Protocol time-out constant 1of COM0.	R/W
LW10047~10048	Protocol time-out constant 2 of COM0.	R/W
LW10056	Work mode of COM1. 0: 232; 1: 485-4w; 2: 485-2w	R/W
LW10057~10058	Baud rate of COM1. Double word..	R/W
LW10059	Data bit of COM1.	R/W
LW10060	Check bit of COM1.	R/W
LW10061	Stop bit of COM1.	R/W
LW10062	Slave station no. of COM1 (HMI station no.)	R/W
LW10063~10064	PLC time-out constant of COM1.	R/W
LW10065~10066	Protocol time-out constant 1of COM1.	R/W
LW10067~10068	Protocol time-out constant 2 of COM1.	R/W
LW10182	Work mode of COM2. 0: 232;	R/W
LW10183~10184	Baud rate of COM2. Double word..	R/W
LW10185	Data bit of COM2.	R/W
LW10186	Check bit of COM2.	R/W
LW10187	Stop bit of COM2.	R/W
LW10188	Slave station no. of COM2 (HMI station no.)	R/W
LW10189~10190	PLC time-out constant of COM2.	R/W
LW10191~10192	Protocol time-out constant 1of COM2.	R/W
LW10193~10194	Protocol time-out constant 2 of COM2.	R/W



1. The above functions will take effect after restart.
2. The value of some local words above will be saved after power off.

● Variables of station number

Address	Description	Read/Write
---------	-------------	------------

LW9416	Variable register of station number. It corresponds to index 0 of variable of station number.	R/W
LW9417	Variable register of station number. It corresponds to index 1 of variable of station number.	R/W
LW9418	Variable register of station number. It corresponds to index 2 of variable of station number.	R/W
LW9419	Variable register of station number. It corresponds to index 3 of variable of station number.	R/W
LW9420	Variable register of station number. It corresponds to index 4 of variable of station number.	R/W
LW9421	Variable register of station number. It corresponds to index 5 of variable of station number.	R/W
LW9422	Variable register of station number. It corresponds to index 6 of variable of station number.	R/W
LW9423	Variable register of station number. It corresponds to index 7 of variable of station number.	R/W
LW9424	Variable register of station number. It corresponds to index 8 of variable of station number.	R/W
LW9425	Variable register of station number. It corresponds to index 9 of variable of station number.	R/W
LW9426	Variable register of station number. It corresponds to index 10 of variable of station number.	R/W
LW9427	Variable register of station number. It corresponds to index 11 of variable of station number.	R/W
LW9428	Variable register of station number. It corresponds to index 12 of variable of station number.	R/W
LW9429	Variable register of station number. It corresponds to index 13 of variable of station number.	R/W
LW9430	Variable register of station number. It corresponds to index 14 of variable of station number.	R/W
LW9431	Variable register of station number. It corresponds to index 15 of variable of station number.	R/W

● **Error code of bus**

Address	Description	Read/Write
LW9145	Record error codes of Profibus.	R
LW9146	Record error codes of Canopen.	R

Macro code operation

Address	Description	Read/Write
LB9116	Macro reading input registers indication. The bit will be set to ON when Macro is reading input registers, set to OFF automatically after finish reading.	R
LB9117	Macro writing output register indication. The bit will be set to ON when Macro is writing input registers, set to OFF automatically after finish writing.	R
LB9118	Macro working indication. The bit will be set to ON When Macro is running (read and write register operation are included), set to OFF after finish.	R
LW9465	Time magnification of Macro time-out. If it is set to N, then the allowable maximum running time for once of Marco is N times as long as the default value.	R/W

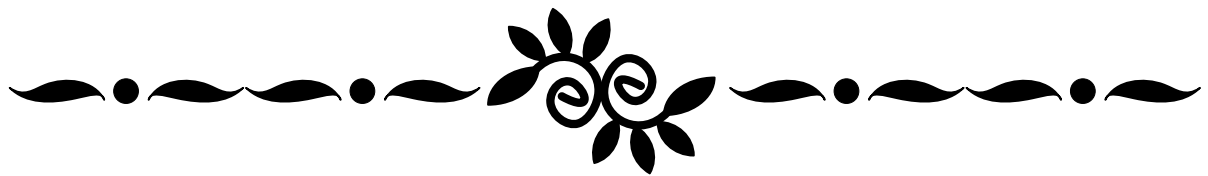

Hardware Part



1 Name and Specification

This chapter mainly introduces names and specifications of the universal parts of MT series HMI.



Names and specifications of the special parts of MT series HMI, please refer to related selection manual.

1.1 Name of Each Part

Names of the universal parts of MT series:

Front:

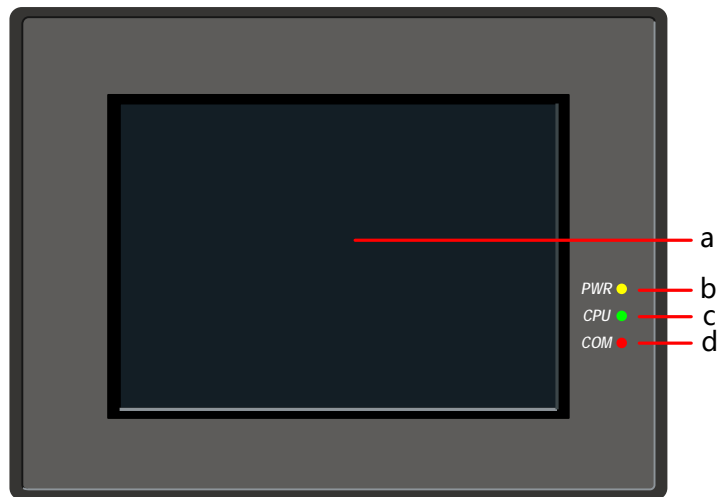

a. Screen display /Touch control area b. PWR indicator c. CPU indicator d. COM indicator

Back:

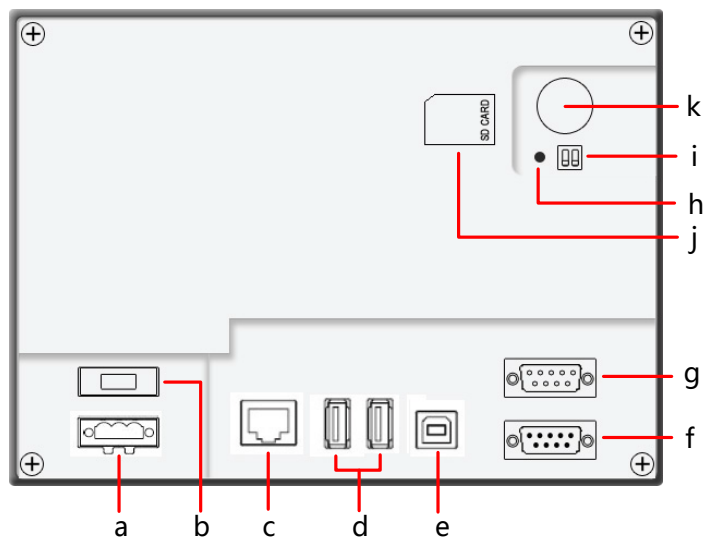

- a. Input terminal of power supply DC24V b. 1A Fuse c. LAN interface d. USB HOST(USB type A interface) e. USB SLAVE(USB type B interface) f. COM1(female) g. COM0&COM2(male) h. RESET Button i. DIP Switch j. SD CARD interface k. One-time button type lithium battery

1.2 Specifications of Each Part

1.2.1 Screen display/Touch control area

The touch panel is for input/output and display.



Caution

In the case of personal safety may be endangered or significant losses may be leaded, please do not use the input function of HMI touch switch as emergency stop switch.

1.2.2 LED indicator

Indicator	Description
PWR	When the power supply of HMI is ON/OFF, the yellow indicator is ON/OFF.
CPU	When CPU works normally, the green indicator is ON.
COM	When HMI communicates with PLC and such controllers normally, the red indicator will frequently flick or be normally ON.



COM indicator only indicates the communication states of PLCs connected to COM0 and COM1.

1.2.3 Power Supply

Input voltage: DC24V±15%

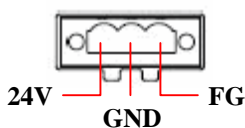

24V: Connect to 24V+ terminal of the power supply.

GND: Connect to COM terminal or 0V terminal of the power supply.

FG: Earthing terminal

1.2.4 Fuse

Fast fuse with rated current 1A is used.



Notice

Fast fuse offers protection when the power supply voltage is too high or power polarity is connected reversely, but it cannot ensure the internal electronic components shall not be damaged.

1.2.5 Serial ports

**Notice**

Please do not hot plug communication cable with charged, to avoid the communication interface being damaged.

- Serial port COM0

COM0 is a 9-pin D-SUB male connector, it supports communication functions of RS-232C/RS-485/RS-422A, and its pin assignment is as follows:

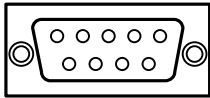

Pin#	Signal	Function		
		RS-232C	RS-485	RS-422A
1	RX-(B)	--	RS485B	Receive data
2	RXD	Receive data	--	--
3	TXD	Send data	--	--
4	TX-	--	--	Send data
5	SG	Signal Ground		
6	RX+(A)	--	RS485A	Receive data
7	NC	--	--	--
8	NC	--	--	--
9	TX+	--	--	Send data

- Serial port COM1

COM1 is a 9-pin D-SUB female connector, it supports communication functions of RS-232C/RS-485/RS-422A, and its pin assignment is as follows:

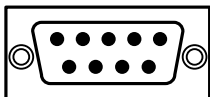

Pin#	Signal	Function		
		RS-232C	RS-485	RS-422A
1	RX-(B)	--	RS485B	Receive data
2	RXD	Receive data	--	--
3	TXD	Send data	--	--
4	TX-	--	--	Send data
5	SG	Signal Ground		
6	RX+(A)	--	RS485A	Receive data
7	CTS	Clear to send	--	--
8	RTS	Request to send	--	--
9	TX+	--	--	Send data

- Serial port COM2

COM2 shares physical interface with COM0, is 9-pin D-SUB male connector, this port only supports communication function of RS-232C, and its pin assignment is as follows:

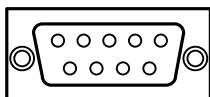

Pin#	Signal	Function
		RS-232C
1	NC	--
2	NC	--
3	NC	--
4	NC	--
5	SG	Signal Ground
6	NC	--
7	RXD	Receive data
8	TXD	Send data
9	NC	--

COM2 can connect with controllers supporting RS-232C, also can be used to upload/download program and debug.

1.2.6 USB interfaces

- USB HOST

USB HOST is a USB A type interface, can connect with peripheral equipments such as USB storage device, keyboard, mouse and so on. Its pin assignment is as follows:

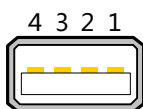

Pin#	Signal	Function
1	VCC	+5V power supply
2	D-	Data-
3	D+	Data+
4	GND	-5V Earthing

- USB SLAVE

USB SLAVE is a USB B type interface, can connect with the USB port of PC, and is used to upload/download program and debug. Its pin assignment is as follows:

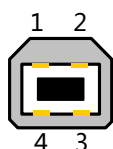

Pin#	Signal	Function
1	VCC	+5V power supply
2	D-	Data-
3	D+	Data+
4	GND	-5V Earthing

1.2.7 LAN interface

LAN port is a 10M/100M transmission speed auto-adapted RJ-45 type interface, can be used to upload/download program and debug; Multiple HMIs equipped with LAN interfaces can be networked at will via this port and communication with controllers supporting Ethernet communication is also supported by this port. Its pin assignment is as follows:

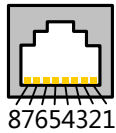

Pin#	Signal	Function
1	TX+	Send data +
2	TX-	Send data -
3	RX+	Receive data +
4	NC	--
5	NC	--
6	RX-	Receive data -
7	NC	--
8	NC	--

1.2.8 SD CARD interface

SD CARD port is suitable for connecting with ordinary plug of which the size is 32mm×24mm×2.1mm. It can be used to save data and quick upload/download user projects, recipes and such files. Its pin assignment is as follows:

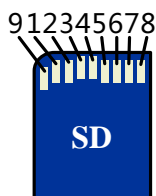

Pin#	Signal	Function
1	CD/DAT3	Card checkout / Data 3
2	CMD	Command
3	VSS1	GND
4	VDD	Power supply (+3V)
5	CLK	Clock
6	VSS2	GND
7	DAT0	Data 0
8	DAT1	Data 1
9	DAT2	Data 2

1.2.9 DIP switch

DIP Switch is used to set the HMI system in different working modes, the corresponding working modes of the setting are as follows:

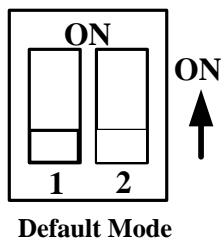

SW1	SW2	Working mode
OFF	OFF	Normal working mode
ON	OFF	More details about Firmware Update Mode, please refer to 【Hardware Part 5 Firmware Update Mode】
OFF	ON	More details about Touch Screen Calibrate Mode, please refer to 【Hardware Part 4 Touch Screen Calibrate Mode】
ON	ON	More details about System Setting Mode, please refer to 【Hardware Part 3 System Setting Mode】

1.2.10 RESET switch

Press the RESET button, HMI will restart.

1.2.11 Button battery

Non-rechargeable button type LI-Mn battery is used, and the standard voltage is 3V. (CR series)

2 Connection with Preiferal Equipments

To meet users' requirements for multifunction screens of intelligence, information, humanity, MT series HMIs have equipped with kinds of interfaces. The equipments supported by the interfaces are described in turn as follows.

2.1 Connection via Serial Port

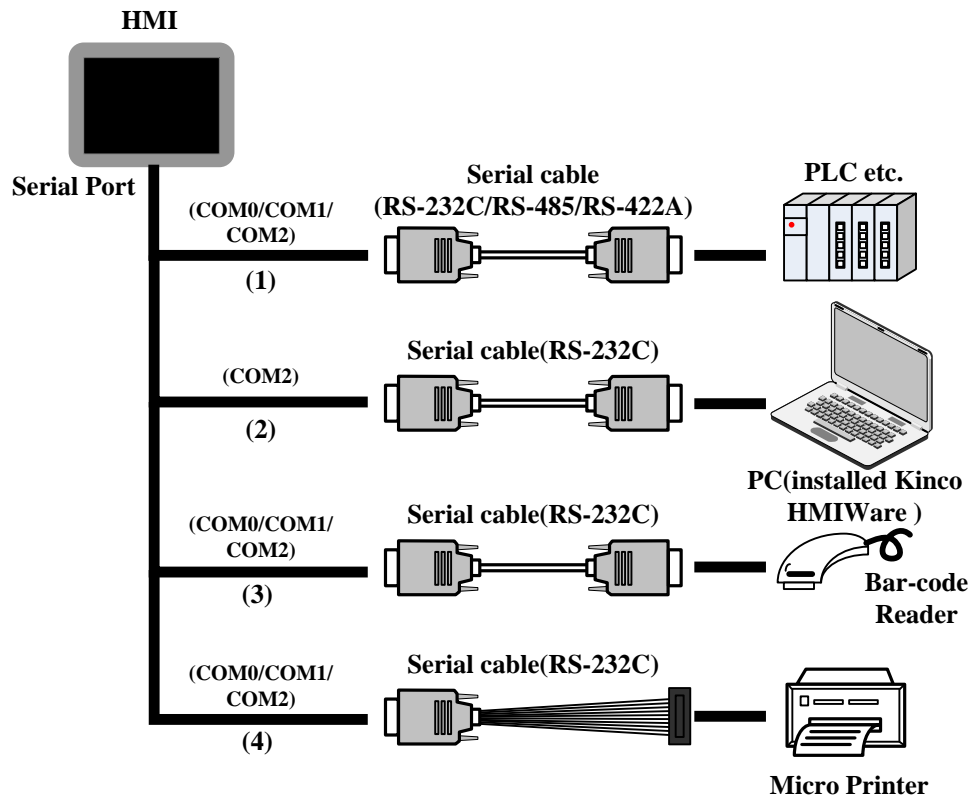

(1) Connect with PLC and other controllers via serial ports to communicate

HMI can connect with the serial ports of PLC and such controllers to communicate via RS-232C/RS-485/RS-422A serial cable.

- Requirements for connection

The PLC and such controllers communicate with HMI must be of the types supported by Kinco HMIWare, or support the serial communication protocols supported by Kinco HMIWare.

- Cable production

Users can make the connection cable by themselves according to the types of controllers and communication modes.

(2) Upload/download data via serial ports

HMI can connect with the serial ports of PC to upload/download user projects, recipes and such data via RS-232C serial cable.

- Requirements for connection

Install and run the HMIWare configuration software of Kinco on PC, select download ways through the **【Tools】** menu of the

software.

 [More details about download please refer to **【Advanced Part 7.3 Download】**](#)

- Cable production

Users can make the connection cable by themselves.

(3) Connect with scanner and such equipments via serial ports

HMI can connect with scanner via RS-232Cserial cable to receive banner code and such data.

- Requirements for connection

The scanners communicate with HMI must be of the types supported by Kinco HMIware, or support the serial communication protocols supported by Kinco HMIware.

- Cable production

Directly use the RS-232C communication cable provided by the scanner manufacturer.

(4) Connect with miniprinter via serial ports

HMI could connect with miniprinters to print screen or data report via RS-232C serial ports.

- Requirements for connection

The miniprinters communicate with HMI must of the types supported by Kinco HMIware, or support the serial communication protocols supported by Kinco HMIware.



More details please refer to the manual of **【Communication Connection Guide】** .

- Cable production

Users can make the connection cable by themselves.

2.2 Connection via USB Interfaces

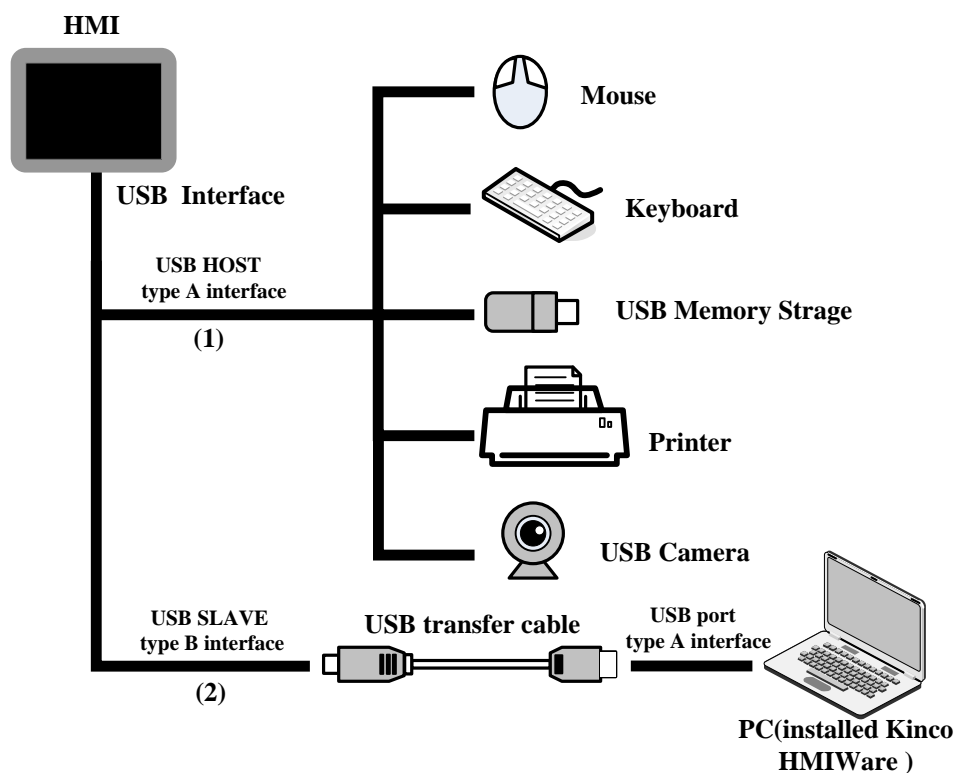

(1) Connect with USB mouse, USB keyboard and such equipments via USB HOST

- Connect with USB mouse

HMI connects with USB mouse, then the USB mouse can execute input operation to the HMI screen.

- Connect with USB keyboard

HMI connects with USB keyboard, then the USB keyboard can execute input operation to the HMI screen via the **【Map Key】** function of Function Key components.

- Connect with USB mass storage device

Connection between HMI and USB mass storage device can be used for:

- Quick upload/download user projects, recipes and such files between HMI and USB mass storage devices via import/export functions;
- A physical storage area (ERW) is divided up from the USB mass storage device, users take access to ERW registers to read/write data directly on HMI.
- Historical data of Trend Curve and XY Curve, historical events, operation log and such data can be saved in USB mass storage devices.

- Connect with USB printer

HMI can connect with USB printers via USB cable to print screen and data report.

The USB printers communicate with HMI must be of the types supported by Kinco HMIware, or support the printer communication protocols supported by Kinco HMIware.



Details about the supported printers please refer to the manual of **【Communication Connection Guide】**.

- Connect with USB camera

HMI can connect to camera with drive type USB to display the video pictures input by USB camera via camera component.

[More details please refer to **【Advanced Part 4.10.2 Camera】**](#)

(2) Upload/download data via USB SLAVE

HMI can connect with the USB interfaces of PC to upload/download projects, recipes and such data via USB cable.

- Requirements for connection

Install and run the HMIware configuration software of Kinco on PC, select download ways through the **【Tools】** menu of the software.

- Cable production

Users can make the connection cable by themselves.



Details about cable production please refer to the manual of **【Communication Connection Guide】**.

2.3 Connection via LAN Interfaces

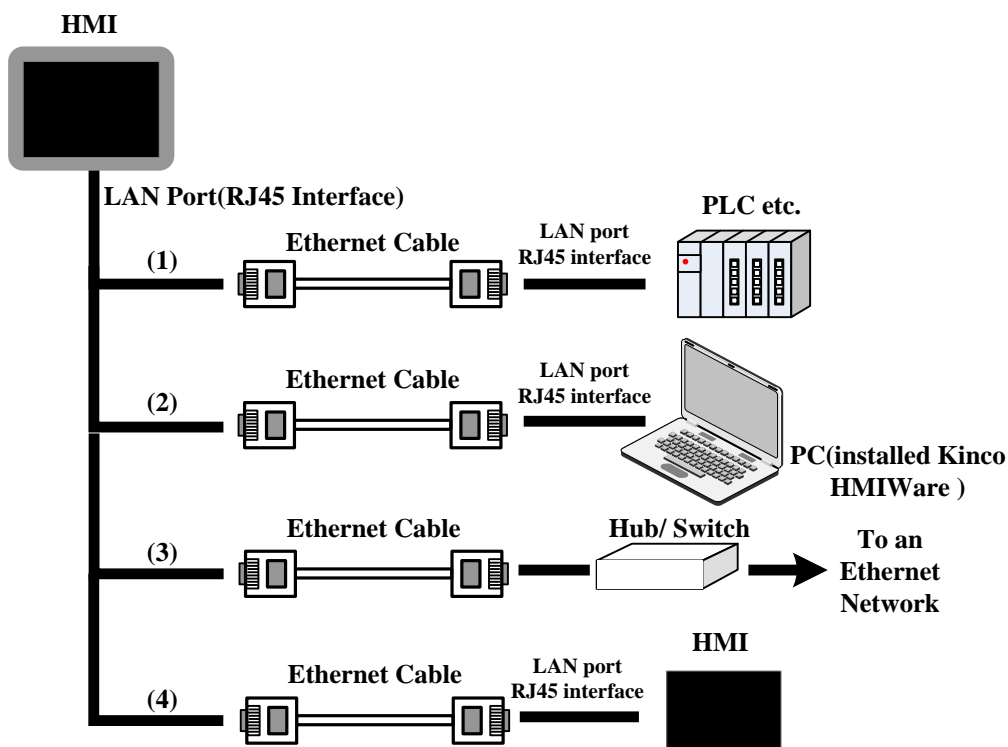

- (1) Connect with PLC and such controllers to communicate

HMI can connect to PLC and such controllers to communicate via an interconnection cable (RJ45 Crossover Cable).

- Requirements for connection

The PLC and such controllers communicate with HMI must be of the types supported by Kinco HMIware, or support the Ethernet communication protocols supported by Kinco HMIware.

- Cable production

Users can make the connection cable by themselves.

(2) Upload/download/monitor data via LAN interface

Via interconnection cable (RJ45 Crossover Cable), HMI can connect with the LAN interface of PC to upload/download user projects, recipes and such data; meanwhile users can monitor the data of HMI or PLC and such controllers on PC.

- Requirements for connection

Install and run the HMIware configuration software of Kinco on PC, select download ways through the **【Tools】** menu of the software.

- Cable production

Users can make the cable for connection by themselves.

(3) Connect HMI to a Local Area Network via Hub/Switch

HMI can be connected to a HUB or SWITCH to access a Local Area Network via a standard Ethernet cable (RJ45 straight-through cable) or interconnection cable (RJ45 cross-over cable). This is mainly used for multiple HMIs links or HMI network with multiple PLC and such controllers.

 [More details please refer to **【Adavanced Part 14 HMI Communication】**](#)

(4) linking via LAN interface

HMI can link to another HMI via interconnection cable (RJ45 Crossover Cable).

- Requirements for connection

All HMIs online are with LAN interfaces, and set **【HMI Attributes】** — **【Networking Device Setting】** in the software.

- Cable production

Users can make the connection cable by themselves.



More details please refer to the manual of **【Communication Connection Guide】** .

3 System Setting Mode

In this mode, users can set such items as system time, Startup Window, IP address.

3.1 Methods to Display System Setting Mode

Enter the System Setting Mode by the following steps :

- ❶ Set the DIP switch SW1 and SW2 to “ON”;
- ❷ Press the “RESET” button, then HMI restarts and enters the SETUP interface.

3.2 System Setting

Take the SETUP interface of MT5320T for example:



In the SETUP interface of MT5320T, the following items can be set:





- Startup Window No.: Startup window. It is the displayed window when start HMI, the default value is 0.
- Backlight Saver Time: Screen saver time, in minutes. The default value is 10. Screen saver is unavailable when the value is 0.
- Buzzer Disabled/Enabled: Enable/Disable the buzzer. For MT5000/4000 series HMI, select “Mute” to close the buzzer.
- Network parameter setting: set the network parameters such as IP Address, Port, Subnet Mask, Gateway of a target screen equipped with Ethernet port.
- Brightness adjustment: Adjust brightness (Brightness Up/Down) to achieve the best visual effect.



Brightness adjustment is not supported by some HMI models.

- Calibrate Time: Check whether the year, month, day, hour, minute and second are the current time, otherwise, calibrate manually.

- Import/Export: Quick upload/download user project files or recipe files. The function is only supported by HMIs equipped with USB HOST/SD Card ports.

	<p>Upload the user project files (.pkg) saved in HMI to USB or SD Card. Upload password is required when upload, the default password is 888888 if it has not been set in the HMI attributes dialogue box.</p>
	<p>Download the user project files (.pkg) saved in USB or SD Card into HMI.</p>
	<p>Upload the recipe files (.rcp) saved in HMI to USB or SD Card.</p>
	<p>Download the recipe files (.rcp) saved in USB or SD Card into HMI.</p>

The SETUP interface may not be displayed in full size in a single screen, then click “Next” or “→” to enter the next page and click Back” or “←” to return the previous page.

4 Touch Screen Calibrate Mode

When the screen touch is not accurate after firmware update, users can calibrate HMI screen under this mode.

4.1 Methods to Display Touch Screen Calibrate Mode

There are two methods to enter the Touch Screen Calibrate Mode:

Method 1: Enter Touch Screen Calibrate Mode by set DIP switches.

- ❶ Set the DIP switch SW1 and SW2 (on the back of the HMI) to “ON”;
- ❷ Press the “RESET” button, then HMI restarts and enters the Touch Screen Calibrate interface.

Method 2: Enter Touch Screen Calibrate Mode by the “Touch Calibration” function of **【Function Key】** .

Method 2 is directly completed on the HMI screen, users do not need to manipulate the DIP switches and without bothering to open the control cabinet.

 [More details please refer to **【Advanced Part 4.2.6 Function Key】**](#)

4.2 Touch Screen Calibrate Setting

Follow the “+” sign to touch the screen until you hear a click sound and the “+” sign disappears, then “TP Adjust Success! ” is showing, which indicates that Touch Screen Calibrate is succeeded. Then, set DIP switch 1 and 2 to “OFF” and press **【Reset】** button, restart HMI to exit Touch Screen Calibrate Mode.

5 Firmware Update Mode

In firmware update mode, users can update the version of the Kernel and Root files system (It is strongly recommended that the users use the function under the guidance of Manufacturer).

5.1 Methods to Display Firmware Update Mode

Enter the Firmware Update Mode by the following steps:

- ❶ Set the DIP switch (on the back of the HMI) SW1 to “ON” and SW2 to “OFF”;
- ❷ Press the “RESET” button, then HMI restarts and enters the Touch Screen Calibrate interface.

5.2 Firmware Update Setting

Open KHManager, enter **【System Operation】** to update the Kernel and Root files system.

 [More details please refer to **【Advanced Part 8 KHManager】**](#)



Please backup the configuration projects, recipe data and so on before update Kernel/Root files system, to avoid data loss during update.

6 Maintenance and Tending

This chapter mainly introduces the maintenance and inspection methods to prevent errors occur, so as to ensure the normal use of the products.



Caution

Do not disassemble the host or touch any internal component in a powered state, otherwise electric shock accidents may be leaded.

6.1 Maintenance

To ensure the HMI in an optimal state, please maintain the following items regularly:

- Engineering data backup

Regularly backup engineering data and store it to safe place, to prevent engineering data loss when HMI malfunctions and in need of repairment and parts replacement.

- Backlight replacement

When the backlight darkens and is difficult to see clearly, then, the backlight should be replaced. The users cannot replace the backlight privately.

When you need to replace the backlight, please contact your local dealer or representative offices.

- Battery replacement

Some HMI models use button type Li-Mn batteries to save recipe data and system time when HMI powers off, when the voltage of the battery is lower than 2.5V, then the battery should be replaced. Users could buy and replace the batteries according to the specified specifications by themselves.

6.2 Tending

- Screen tending

When the screen gathers dust or dirt, please disconnect the power supply for HMI, then, soak a piece of soft cloth in neutral detergent and wring it to dry, and then wipe the screen gently.



Prohibition

1. Do not use paint thinner, organic solvent or strong acid mixture to clean the screen.
 2. Do not use hard or sharp objects to operate or wipe the screen, otherwise, screen surface will be damaged.
-

- Periodic inspection

To ensure the HM in an optimal state, please inspect the following items regularly:

Appendix 3 List of System Prompt Message

➤ Working environment

Whether the temperature or humidity of HMI working environment is in the specified range?

Whether there is corrosive or flammable gas in the working environment of HMI?

➤ Electrical performance

Whether the power supply input voltage is in the specified range?

➤ Others

Has any of the power cable or power cord of the power supply terminals been loosened?

Whether all the installed fasteners are locked tight?

Appendix 1 Regular PLC Used for HMI

Brand	Connecting device	description
ABB	AC31/ AC500	
(Rockwell) Allen-Bradley	MicroLogix PLC	AB SLC500/PLC5/MicroLogix
	SLC500 PLC	Series(DF1)
	PLC-5 PLC	AB SLC500/PLC5/MicroLogix Series Ethernet(TCP Slave)
	CompactLogix PLC	AB CompactLogix/ControlLogix
	ControlLogix PLC	Series(DF1) AB CompactLogix/ControlLogix Series Ethernet(TCP Slave)
(Advantech) ADAM	ADAM-4015/ ADAM-4017	
Baldor	NextMove ES Controller	
Baumuller	BM4413-ST0-02200-03	
Bosch Rexroth	KVFC+ Inverter	
	PPC-R Series Controller	
	IndraLogic L Series Controller	Bosch Rexroth Bosch Rexroth Ethernet
(CAN) CANOpen Node Slave	Kinco k4	
	Other company devices which support CANOpen	
Danfoss	FC-300	
Delta	DVP PLC	
	DVP	
Emerson	EC10/ EC20 Series PLC	
Facon	FBS/ FBe/FBn	Facon FB/Modbus RTU
Fuji	SPB Series PLC/ NB Series PLC	
GE	Fanuc Series 90-30 Series PLC	GE Fanuc Series SNP/GE SNP-X
	Fanuc Series 90-70 Series PLC	Modbus TCP
	VersaMax Series PLC	
	VersaMax Micro&Nano Series PLC	
	PACSystem RX7i Series PLC	
Hitachi	H Series PLC	

	EH-150 Series PLC	
	MICRO-EH Series PLC	
	SJ300 Inverter	
Hollysys	LM Series PLC	
	LK Series PLC	Hollysys LK Modbus RTU Hollysys LK Modbus TCP Slave
IDEC	Micro Smart Series PLC	
Inovance	H2U Series PLC	Inovance H2u Modbus RTU
Kinco	Kinco K3 PLC	
	ED Series Servo	
	CD Series Servo	
	EB-MOD2P-01	Modbus RTU Kinco EB-MOD2P-01
	EB-MOD2P-11	
Keyence	KV-16DT/ KV-1000/ KV-3000/ KV-5000	
Lenze	Lecom A/B Series Inverter	
LS	Master-k Series PLC	LS K-Master Cnet LS K-Master CPU Direct LS K-Master Modbus RTU
	XGT Series PLC	LS XGT Cnet LS XGT CPU Direct
	GLOFA Series PLC	LS GLOFA Cnet LS GLOFA FEnet
LUST	CDE34.008	
	ServoOne junior	
Mitsubishi	FX Series PLC	
	Q Series PLC	
	FX Series Link Module	
	QJ Series Link Module	
Modbus	Modbus RTU	
	Modbus RTU Extend	
	Modbus RTU Slave	
	Modbus RTU MT500 Compatible	
	Modbus ASCII	

	Modbus TCP	
	Modbus TCP Slave	
	Modbus UDP	
	Modbus UDP Slave	
Omron	C Series PLC	
	C Series Link PLC	
	CJ2 Series PLC	
	CJ1 Series PLC	
	CS1 Series PLC	
	CJ Series Link Module	
	CS Series Link Module	
	E5EZ-R3 Controller	
OPTO	SNAP	
Panasonic	FP Series PLC	
Parker	Compax3 Series	
	SLVD Series	
	6K4 Series	
Profibus DP Slave	Siemens S7-300/ Siemens S7-400	
	Other company devices which support PROFIBUS DP Master	
Schneider	Micro Series PLC	Modbus RTU
	Premium Series PLC	Schneider Modicon Uni-TelWay
	Nano Series PLC	
	Twido	
Siemens	S7-200	SIEMENS S7-200 SIEMENS S7-200 Ethernet(TCP Slave)
	S7-300	SIEMENS S7-300/400(PC Adapter Direct) SIEMENS S7-300/400(MPI Direct) Profibus Slave SIEMENS S7-300 Ethernet(TCP Slave)
	S7-400	SIEMENS S7-300/400(PC Adapter Direct) SIEMENS S7-300/400(MPI Direct) Profibus Slave SIEMENS S7-400 Ethernet(TCP Slave)
	S7-1200	

Thinget	XC3-32R-E	Modbus RTU Thinget Controller
Trio	Euro	Trio Modbus RTU Extend
Vigor	VH series PLC/ VB0 series PLC	
Yaskawa	V Inverter	
	MP Series	Yaskawa MP2300 Yaskawa Ethernet(UDP Slave)
	Σ II / Σ II Plus Servo	
Yokogawa	FA-M3	Yokogawa FA-M3 Yokogawa FA-M3 Ethernet(TCP Slave)
YuDian	AI Series PLC	

Appendix 2 List of Error Information

No.	Error information	Description
1	Compilation failed! No compiled PKG files are generated!	Macro code or other reasons result in compilation failing, no compiled PKG files are generated.
2	Warning: Init. Start Window does not exist, the software will add the default Init. Start Window automatically!	The initial start picture saved in the original project possibly has been lost, the system will automatically replace it with Kinco initial start picture.
3	Logo's size is too big, please adjust it! Logo's size is out of limit: Width*Height > 2097152	The bitmap imported for Initial Start Window is bigger than the software restriction.
4	Logo file error!	HMI0.lg file went wrong.
5	HMI%s logo compile failed!	HMI0.lg corresponding to Logo does not exist, or the picture used by logo does not exist.
6	Current HMI can not support this component!	The current HMI does not support the component.
7	Export file already exist, do you want to replace it?	The same file is exported to the same path repeatedly.
8	Unable to write file, export failed!	The exported file name is possibly illegal.
9	Unable to parse file, import failed!	The file to import does not exist or the file format is discrepant.
10	The project is existed in your selected content, replace the old one?	The new project is of the same name with the already existing project in the path.
11	Project has been opened, can not open repeatedly!	Kinco HMIware cannot open one project repeatedly.
12	The new version project can not be opened by the old version software! Please update your software!	Software of low version cannot open the project edited by new version software. The software is upward compatible, please use the new version software.
13	Can not save project. Please check the following files permission!	The project is set to read only and cannot be modified and saved again.
14	Save project error, please resume you project from \"temp\" directory in your project directory!	The project saved last time will be backupperd automatically in the \"temp\" directory.
15	The project had been modified, please save and compile first!	After modifying, the project should be saved and compiled again.
16	Can not find compiled file, please compile first!	PKG file is wrong or lost.
17	A same name project already exists in this folder, please select another folder!	Projects of the same name cannot be saved in the same path.

18	Software was closed abnormally last time, whether restore the unsaved project?	Prompt when reopen the project after abnormal close.
19	The project is created by old version software .Do you want to backup and update the project now?\n\nWarning:the updated project can not be opened by old version software!	Prompt for backuping when use high version software to open the project edited by low version software.
20	System default window, unable to delete!	Frame0~9 are the system default windows, cannot be deleted.
21	Rename variable error!	The variable names possibly include “? ”, “\ ”, “/” and such illegal characters.
22	Project incompleted!	There are only serial port cables or PLCs in the Construct Window.
23	Project error: some HMIs, PLCs or connectors are not be connected!	HMIs, PLCs and communication cables do not be connected properly in the Construct Window.
24	After delete, all related pictures will lost and can not be recovered! Do you want to continue?	When delete the HMIs in the Construct Window, all the configuration pictures will be deleted and cannot be recovered, please be cautious with this operation.
25	After delete, all related register address for the plc items will be set default value and can not be recovered! Do you want to continue?	When delete PLCs, all the registers related with PLC will be changed to HMI default registers, and cannot be recovered, please be cautious with this operation.
26	If remove all, all objects will be deleted and can not be recovered! Do you want to continue?	Prompts of 【Delete all】 in the attribute box of BUS, events, alarms, text libraries, address labels, PLC control.
27	After replace, some parts of the HMI will change position, size or colour, and can not be recovered! Do you want to continue?	When replacing HMI models, the different screen sizes will lead to some components’ attributes be adjusted automatically in the configuration project.
28	Element or the special function of the element. It has been deleted!	When replacing HMI, some components not supported by the new HMI will be automatically deleted due to different hardware, for example Video, Historical Event Display and such components.
29	Project contains some HMIs which are not supported by current version software. These HMIs had been auto updated to some available HMIs:\n\n	The discontinued HMI models have been deleted in the configuration software of higher version, the discontinued HMI model will be replaced automatically when open the project edited by low version software.
30	Error: address cross-border	The addresses exceed the allowed range.
31	Error: address format error	The address format does not match with the actual format of

	Error: address input error	component, possibly decimal number is written to octonary system, or entered characters are illegal.
32	Invalid address type!	Address type not supported by the driver protocols is used in the project.
33	The files are damaged or deleted, can not play!	Audio files faulted.
34	Load system word library error!/ Vector font files used in project does not exist, please close the project, install the missing font files	If the font library used in the project does not exist in the computer, then song typeface will be taken as default when opening the project.
35	Copy error: the destination window ID already exists!	Source windows cannot be copied to the existing windows.
36	Size too large, can not be pasted!	Copy component across windows or projects, the component size should be smaller than target window.
37	The size of File %s is larger than 256K, the file can not be added to sound library!	Audio file imported into audio library should be less than 256k.
38	The fieldbus device is already defined, do you want to replace it?/ Network device is already defined,do you want to replace it?	If a fieldbus or network device is already defined in HMI, it will prompt when you add the same fieldbus or network device again.
39	Only one protocol can be defined in a device!	Prompt when the same protocol is added repeatedly in the same fieldbus device.
40	The Invalid Path!/ The Invalid ProjectName!	Prompt when saving project as or opening project but there is no path or project name checked.
41	Bottom Window Error: the frame can not be used as both parent window and bottom window!	Two windows cannot be used as mutual bottom window.
42	Window size settings failed, please adjust parts position first, then reset the windows size!	The width and height values of the modified window should be bigger than its coordinate values.
43	Image of GIF/PNG format or with alpha channel do not support the additional transparent color treatment!	In picture editing window, transparent color treatment is invalid for image of GIF/PNG format or with alpha channel.
44	Error: Please select at least one display condition!	【Conditional display】 of component is chosen, but no display condition is checked and click 【OK】 .
45	Part size error: Width and height of part can not less than 1!	The width and height values should both be bigger than 1 when modifying component size.
46	Error: The content cannot be empty!	When static text is used, it must not be empty.
47	Error: Text size must less than screen size!	The input content of static text is too long and exceeds the screen size.

48	Same item exists in the text library, whether or not to replace?	Prompt when import text library and there is item of the same name already existed.
49	Error: Text size must less than screen size!	The Fonts are too big that exceed the display area of the components and windows.
50	The HMI does not support the HistoryDataDisp components!	KW5300T/KM5303T/KG5509T/KG5300T do not support historical data display.
51	HMI cannot support USB2!	MT4220TE/4414TE/4424/4522/4523/4620TE are equipped with only one USB host.
52	IP address is already defined, please check it/ IP address conflict, please check it!	When there are multiple HMIs in the configuration and network communication protocol is used to network, the IP addresses cannot repeat.
53	The station NO. is already defined, please check it!	When adding new PLC, there is the same station no. already existing in the same protocol.
54	The window id is incorrect or the window exists, please input another id!	The number for the new frame is illegal or the number is already existed.
55	The current screen does not support the property of sound !	The target HMI does not support audio.
56	The hmi %s doesn't support the property of Save screen shots to extend memory!	The target HMI does not support external storage devices.
57	Failed to open file	File error when uploading.
58	Cannot open Serial Port	Serial port may be occupied already.
59	Open usb handel fail	USB cable is not connected or the USB port is broken, or the USB driver is not installed successfully.
60	Send data error/read data error/Data checksum error/file checksum fail	Errors appear during downloading, so data received by HMI is inconsistent with data sent by upper machine, please unplug the communication cable between HMI and PLC, restart HMI and try again.
61	Recipe file size error	Recipe size is larger than HMI recipe registers.
62	No download option was be selected	Click the 【Download】 button when no download option is chosen in KHDdownload dialog box.
63	Unsupport HMI, download failed!	The model of the HMI is not supported by the used software, high version software should be used.
64	Please use method of big BMP zipped or simplify configuration project	The project is too large to be downloaded, please check whether lots of bitmaps or vector fonts are used in the project and simplify the project and download again.

65	create file fail	Cannot download to external storage device, possibly there are illegal characters included in the file name.
66	Save file fail	Prompt when download to external storage device and the memory is insufficient.
67	Upload password must contain nonzero character!	The password cannot be zero when setting upload password in 【HMI Attribute】 page.
68	Invalid Password, please Input Password again!	Upload password entry failure.
69	password checksum fail	Prohibiting upload is set in the target HMI program.
70	Invalid Password. Project cannot be opened!	After the project is encrypted, password input is wrong when open project.
71	password error, please reset system and try again	Password for decompilation is input wrong repeatedly.
72	Failed to upload file	Data package lost when uploading file, please unplug the communication cable between HMI and PLC, restart HMI and try again.
73	No select decompile PKG file	Click 【Decompile】 button when no PKG file or target project for decompilation is chosen.
74	Number of PKG Files wrong , can not decompile!/ PKG file is not generated by the same project and same build, can not decompile!	When multiple HMIs are networked, decompilation is not supported.
75	PKG file does not allow decompile!	Prohibit decompiling is set in the 【HMI Attributes】 page.
76	PKG file edited by configuration software version lower than 1.2.3.0 cannot be decompiled!	Only the PKG files edited by software version higher than version 1.2.3.0 can be decompiled.
77	Another decompile process has not ended, please closed it first!	Prompt when starting a new decompilation while there is a decompilation in process.
78	A same directory exists, delete it and continue?	Target project file cannot be saved in the same directory with the original PKG file.
79	Online Simulation overtime and Program is end, if want, Please Simulate again	Maximum duration for direct online simulation is 15 minutes, after the time run out users need to simulate again.
80	An instance of software already exists, please close it first!	Only one simulation process can be executed at one time.

Appendix 3 List of System Prompt Message

Edit/Mask	Mask address	Prompt message	Description
Allow mask/edit	LW.B9296.0	[0]System Error	System error (Possibly file system fault)
	LW.B9296.1	[1]PLC Response Error	Communication with PLC error, possibly the selected driver protocol do not support the current connected PLC (Read/write error)
	LW.B9296.2	[2]PLC No Response :xx-xx-x	PLC no response: xx-xx-x (HMI No.-PLC station No. – Port No.) (Communication with PLC fail, please check communication cable and whether the communication parameters of PLC AND HMI are consistent)
	LW.B9296.4	[4]Socket Connect Error	Connect to server failed. (Connect to local or remote server failed. Usually network communication faulted or PLC driver faulted, very occasionally may communication cable of PLC fault)
	LW.B9296.5	[5]Socket COMM Error	Communication with server error
	LW.B9296.6	[6]MacroCode Error:xxxx	Macro code xxxx execution error (Check marco code, possibly there are memory access cross-border or dividing by zero errors in marco code)
	LW.B9296.7	[7]Print Error	Print error (communication with printer error. Please check printer connection, make sure that whether the current printer is supported by selected printer protocol)
	LW.B9296.8	[8]Send Package Error	Send network message failed.
	LW.B9296.9	[9]Memory Shortage	Run out of memory (Possibly open two many popup windows or components occupying too much resources, check whether use too many popup windows, direct windows, indirect windows, trend curves, oscillographs, XY plots, alarms and events in project)
	LW.B9296.A	[10]BCD Transform Overflow	BCD conversion outflow. Check whether BCD settings of component are correct.

	LW.B9296.B	[11]MacroCode Timeout:xxxx	Marco code xxxx executing timeout (Macro execution time is too long or there is an endless loop)
	LW.B9296.E	[14]RW Access Overflow	Recipe memory access cross-border (The accessed recipe address is beyond current allowable range of HMI)
	LW.B9296.F	[15]Waiting to Print	Waiting for printing. Printing dada is under processing (This is a normal prompt during printing)
	LW.B9297.0	[16]Servo Not Ready	Server data is not ready (possibly server error), or possibly firmware error or PLC driver error.
	LW.B9297.2	[18]Transmit Data Failed	Data transmission failed.
	LW.B9297.3	[19]Data Input Failed	Number input failed, the input value exceeds the minimum/maximum values of number input component.
	LW.B9297.4	[20]Device Error	Device fault (Access to input/output devices error, possibly file system or firmware fault)
	LW.B9297.5	[21]Copying File ...	File is in copy (This is a normal prompt during project export or screen shoot)
	LW.B9297.6	[22]Copy File Failed	File copy failed (Project export or screen shoot fail)
	LW.B9297.7	[23]Invalid File	Import file is invalid (Filename invalid)
	LW.B9297.8	[24]Password Error	Input password wrong
	LW.B9297.9	[25]SD Card Full	SD card is full
	LW.B9297.A	[26]USB Disk1 Full	U disk 1 is full
	LW.B9297.B	[27]USB Disk2 Full	U disk 2 is full
	LW.B9298.0	[32]RTC Device Error	RTC clock fault (possibly RTC chip fault)
	LW.B9298.2	[34]Invalid UserName	Invalid user name (The input user name is invalid when login or add/delete user)
	LW.B9298.3	[35]Operation Complete	Prompt of operation success (This is normal prompt during printing when adding/deleting user or modifying password)
Do not allow edit/mask mask bits	No	DOWNLOAD/SIM MODE	Enter download mode
	corresponding	STRAIGHT MODE	Enter straight mode
	mask bits	SIMULATION MODE	Enter indirect online simulation mode

	LOAD PKG OK!	Project download success.
	LOAD PKG ERROR!	Project download fail.
	TP adjust success!	Touch screen calibration success.
	TP adjust fail, try again!	Touch screen calibration fail, calibrate again.
	DOWNLOAD/SIM MODE User Data invalid, please redownload!	There is no project in HMI, download project again.
	Kinco HMIware version too low! Please compile with new version!	The software version is too low, please use the newest version, compile and download project again.
	System Crash	HMI system crash, possibly project is too large or firmware error.